

OCULUS Pentacam® AXL Wave



INSTRUCTION MANUAL

System for measuring and analyzing the anterior eye segment,
optical biometry, wavefront aberrometry of the entire eye and retroillumination

Notes on this instruction manual

The Pentacam® AXL Wave has been manufactured and tested according to strict quality criteria.

To ensure safe operation, it is essential that you use the device correctly. For this reason you should familiarise yourself thoroughly with the contents of this instruction manual before operating the device. In particular, pay attention to the safety instructions.

- This instruction manual describes how to manage patient data, the default settings of the Pentacam® AXL Wave program and the measuring process.

Due to ongoing development, the diagrams shown may depict minor changes to the actual device delivered.

If you have any queries or would like additional information about your device, do not hesitate to call or send us an email or a fax. Our service team will gladly assist.

OCULUS Optikgeräte GmbH

Article number: G/70020/XXXX/EN

Release: 06.05.2022

Revision: 08

Table of Contents

1	Delivery and Deliverables	1
2	Symbols	4
3	Structure of the Documentation	5
4	Safety Instructions.....	6
4.1	About this Manual	6
4.1.1	Pictogram Used in this Manual	6
4.2	Safety Instructions for Use	7
4.3	Cybersecurity Instructions	12
5	Intended Use.....	15
6	Device Description	17
6.1	Overview of the device components.....	17
6.2	How the Pentacam® AXL Wave works	18
7	Setup and Connection	19
7.1	Electrical Connection	20
7.2	Switching On	21
7.3	Switching Off.....	21
7.4	Software Installation on separate PCs	22
8	Patient Data Management	23
8.1	Starting Patient Data Management.....	23
8.1.1	Entering a New Patient.....	24
8.1.2	Selecting an Existing Patient	24
8.2	Starting the Pentacam® AXL Wave Software.....	25
9	Using the Pentacam® AXL Wave Program	26
9.1	Blank Overview Display.....	26
9.2	Starting an examination.....	27
9.3	Pentacam® AXL Wave Overview Screen	27
9.4	Loading previous examinations	29
9.5	Helpful information	29
10	Information on Modes	30
10.1	Information on Aberrometry Mode	30
10.2	Information on Retroillumination Mode	30
10.3	Information on Axial Length Mode	30
10.4	Information for Tomography Mode.....	31
11	Measuring Procedure	32
11.1	Preparing the Measuring Procedure.....	32
11.2	Measuring Procedure to Measure the Wavefront Aberration	36
11.2.1	Quality Specifications and parameter for wavefront aberrometry	38
11.3	Capturing Procedure for the Retroillumination.....	40

11.4	Measuring Procedure to Measure the Axial Length	42
11.4.1	Quality Specifications for Biometry	46
11.5	Measuring Procedure for Tomography	48
11.5.1	Quality Specifications for the Tomography.....	50
11.6	CSP Pro measurement.....	53
11.6.1	Quality specification for CSP Pro measurement.....	55
11.6.2	Perform further measurements.....	56
11.7	Perform a Single Scan for an Examination Mode	59
11.7.1	Procedure to take a single scan.....	60
11.7.2	General settings	61
11.7.3	Scheimpflug image settings	61
11.8	Manual measurement function in the Scheimpflug image...	64
12	Managing Patient Data	66
12.1	Rename Patient Data.....	66
12.2	Exporting Patient Data.....	66
12.3	Importing Patient Data	68
12.4	Data Backup.....	69
12.4.1	Backup Data	70
12.4.2	Reconstructing Data	70
12.4.3	Automatic Backup	71
13	Test Measurements with the Pentacam® AXL Wave	71
13.1	Test Measurement: Axial length	71
13.1.1	Attach the test eye.....	71
13.1.2	Perform the Axial length test measurement routine.....	72
13.2	Test Measurement: Tomography (3D scan).....	75
14	Cleaning, Disinfection and Maintenance	77
14.1	Cleaning	77
14.2	Disinfection	78
14.3	Maintenance	79
14.4	Attaching Paper to the Chin Rest.....	80
15	Troubleshooting.....	81
16	Transport and Storage	82
16.1	Information on Transport and Storage.....	82
16.2	Disassembly.....	83
16.3	Transport and Storage.....	83
17	Disposal.....	84
18	Terms of Warranty and Servicing	84
18.1	Terms of Warranty.....	84
18.2	Assumption of Liability for Functions and Damage.....	85
18.3	Manufacturer and Service Address	85
19	Technical Data.....	86

20 Annex.....	89
20.1 Electromagnetic Compatibility.....	89
20.2 Guidance and Manufacturer's Declaration - Electromagnetic Emissions and Immunity for the Pentacam [®] AXL Wave	91
20.3 Description of the Connection.....	95
20.4 Data Sheet HEMG 49-S240210-7 (05150150)	96
20.5 Instructions for integration into an IT-Network.....	98

1 Delivery and Deliverables

Product and accessories	Order number
Pentacam® AXL Wave	70020
x-y base	70480
Support plate	78060
Cograil	027051701004
Cover	027051701005
Sliding plate	017051701007
Chinrest paper	65313
Head and chinrest	70518
Pentacam® AXL Test eye	70108
Pentacam® AXL Wave® accessories	78005
<ul style="list-style-type: none"> ■ Power supply 	05150150
<ul style="list-style-type: none"> ■ Dark sheet 	017070000006
<ul style="list-style-type: none"> ■ Washing manual 	10001961
<ul style="list-style-type: none"> ■ Wire clip 	027075000004
<ul style="list-style-type: none"> ■ Hexagon screwdriver 	05520010
Instruction Manual	G/70020/XXXX/EN
User Guide	UG/70700/XXXX/EN
Software Installation	SI/50000/XXXX/EN
Additional accessories:	
<ul style="list-style-type: none"> ■ Dustcover 	026010005001
<ul style="list-style-type: none"> ■ Hard drive, package 	70005
<ul style="list-style-type: none"> ■ Y cable with galvanic isolation 2 m 	70002
<ul style="list-style-type: none"> ■ Extension cable for Y cable 4 m 	10002173
<ul style="list-style-type: none"> ■ Electric cable EU 	05200320
<ul style="list-style-type: none"> ■ Electric cable Switzerland 	05200322
<ul style="list-style-type: none"> ■ Electric cable Argentina 	05200323
<ul style="list-style-type: none"> ■ Electric cable US 	05200210
<ul style="list-style-type: none"> ■ Electric cable GB 	05200211
<ul style="list-style-type: none"> ■ Electric cable Australia 	05200212

Software module	Order number
Standard software package Pentacam® AXL Wave:	
<ul style="list-style-type: none"> ■ Floating License Key with manual 	77900 SI/77900/XXXX/EN
<ul style="list-style-type: none"> ■ Basic software 	70015
<ul style="list-style-type: none"> ■ Viewing License 	70768
<ul style="list-style-type: none"> ■ Fast Screening Report 	70927
<ul style="list-style-type: none"> ■ Pentacam® AXL Wave Data-USB-Stick 	017090901001

Optional software module	Order number
IOL Calculator	70110
Contact Lens Fitting incl. Fourier Analysis	70726
3D pIOL Simulation Software and Aging Prediction	70928
Belin/Ambrósio Enhanced Ectasia Display	70728
Holladay Report & Holladay EKR65 Detail Report	70729
Corneal Optical Densitometry	70926
Module DICOM PACS	70718
PNS and 3D Cataract Analysis	70727
License Package Optometric Screening	10009399
<ul style="list-style-type: none"> ■ Belin/Ambrósio Enhanced Ectasia Display ■ Corneal Optical Densitometry ■ Show 2 examinations ■ 4 Maps selectable 	
License Package CSP	10013369
<ul style="list-style-type: none"> ■ CSP Pro ■ CSP Report 	
License Package Contact Lens	10009398
<ul style="list-style-type: none"> ■ Contact lens fitting ■ CSP Pro/CSP Report ■ Zernike Analysis ■ Compare 4 examinations 	
Software Package Cataract	70820
<ul style="list-style-type: none"> ■ Cataract Software ■ PNS and 3D Cataract Analysis ■ Zernike Analysis 	

Optional software module	Order number
Software Package Refractive <ul style="list-style-type: none"> ■ Refractive Software ■ Corneal Optical Densitometry 	70810
Full Sequence measurement	10006911
Display Full Sequence Overview	10006910
Display Aberrometry	10006909
Visual Performance Ophthalmology	70040
Display "Compare 4 examinations"	10009400
Show 2 examinations	10009401
4 Maps selectable	10009402

We reserve the right to change the scope of delivery in line with ongoing technical development.

- ➔ If you find transport damage upon delivery, immediately file a claim with the transport company.
- ➔ Have the damages noted on the bill of lading, so that your claim for damages can be handled properly.

For more information regarding shipping and handling, see [sec. 16, page 82](#).



- The software version of the patient data management appears in the settings of the patient data management software.
- The software version of the Pentacam® AXL Wave program appears in the Pentacam® AXL Wave Miscellaneous settings.
- The minimum screen resolution of the Pentacam® displays is 1280x720 with a text size of 100%.

2 Symbols

Symbols on the device		Symbols, packaging				
	Manufacturer		Protection class		Keep dry	
	Date of manufacture	IP XX	Type of protection		This way up	
	Conformité européenne		Article number		Fragile	
	Follow instruction for use		Serial number		Transport	Limit of temperature for transport
	Disposal in household trash is prohibited		Medical device		Storage	Limit of temperature for storage
	Applied part Type B		Attention		Limit of humidity	
(21) ABCDEFG123456789 (01) 04049584000040	Example: UDI number, consisting UDI-DI (Device-Identification) UDI-PI (Product Identifier) machine-readable matrix code				Limit of air pressure	

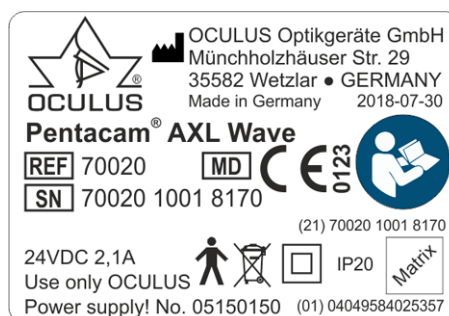

Fig. 2-1: Name plate (example)

3 Structure of the Documentation

A folder containing documentation is supplied with your Pentacam® AXL Wave:

- **Instruction Manual:** The design of the unit is described in detail in this document. The instruction manual also gives you general information about working with the Patient Data Management system and all safety-related instructions for use of the Pentacam® AXL Wave.



Attention

All safety-related instructions for use of the Pentacam® AXL Wave are given in the Instruction Manual for the unit. It is imperative that you read and understand the whole Instruction Manual before you use the Pentacam® AXL Wave.

-
- **User Guide:** All features of the examination and analysis software are described in the User Guide, along with detailed information about the Patient Data Management system.
 - **Software Installation:** The introduction to the Software Installation describes how to install the Pentacam® AXL Wave software and the associated drivers.
 - **Manual Floating License Key:** Information on the use of the Pentacam® AXL Wave within networks.

4 Safety Instructions

4.1 About this Manual

- ➔ Carefully read through the Instruction Manual.
- ➔ Keep the Instruction Manual in good condition near the device.
- ➔ Observe the legal regulations with regard to accident prevention.

If standards are named without an issue date, the current version always applies.

4.1.1 Pictogram Used in this Manual



Attention

Identifies a potentially dangerous situation which may cause minor injury or damage to property.



Note

Denotes situations which could result in incorrect findings, denotes user instructions and useful or other important information.



Identifies important information about the product and its use which require special attention.

- > This symbol denotes menu paths and screenshots. Example for starting a new examination:

Pentacam[®] AXL Wave > Examination > Scan

which means:

- ➔ Select the "Examination" menu from the menu bar.
- ➔ Select the menu item "Scan".

4.2 Safety Instructions for Use



Attention

Personal injury or property damage due to improper operation

→ Observe the following safety instructions.

Personal injury or property damage due to equipment modifications that could jeopardize safety

- No modifications may be made to this device without the permission of the manufacturer. Only the OCULUS service are allowed
- to modify the device or the associated lifting table
 - to install software and software updates.
-

Any serious-incident that has occurred in relation to the device should be reported to the manufacturer (vigilance@oculus.de) and the competent authority of the region in which the user and/or patient is established.

Instructions for Operating Personnel

- Make certain that the Pentacam® AXL Wave is used exclusively in clinics and by eye specialists and opticians (trained staff etc.). It must be used in the area designated for carrying out examinations. For this reason the device may only be operated by personnel instructed to do so, who, with appropriate training, knowledge and practical experience, are able to ensure proper handling of the device.

Transport and Storage Instructions

Refer to the notes in [sec. 16, page 82](#).

Instructions for Setup and Connection

- Only OCULUS or an authorized dealer is allowed to set up and to connect the Pentacam® AXL Wave.
- Do not use or store the Pentacam® AXL Wave in rooms that are humid, see [sec. 16, page 82](#).
- Keep the Pentacam® AXL Wave away from water that may drip, splash or spray on it, and make sure that no liquids can get into the Pentacam® AXL Wave. Do not place any containers holding liquids in the vicinity of the Pentacam® AXL Wave.
- Germany: Only operate the Pentacam® AXL Wave in rooms used for medical purposes after they have been set up according to the VDE Regulation 0100-710.

- Do not operate the devices included in the delivery in areas where explosions may occur, or in proximity to flammable anesthetics or volatile substances such as alcohol, benzine or similar products.
- Set up the Pentacam[®] AXL Wave so that the power plug is easy to access. That way, you can easily disconnect it from the power supply for any repairs or maintenance work.
- Do not force any plug connections.
If you are unable to make a plug connection, check whether the plug fits the socket.
If you detect damage to the connection, you should let authorized dealer repair the damage.
- Only use a device which is mounted at the lifting table properly.

Patient environment information

Patient environment is the area where patients can come into contact with any part of a medical electrical equipment (ME equipment) or with another person being in contact with the ME equipment.



Attention

In the patient environment, use devices that conform to IEC 60601-1. If a multiple power socket is to be used, or if a device is to be used that does not meet the IEC 60601-1 standard, use an isolating transformer.

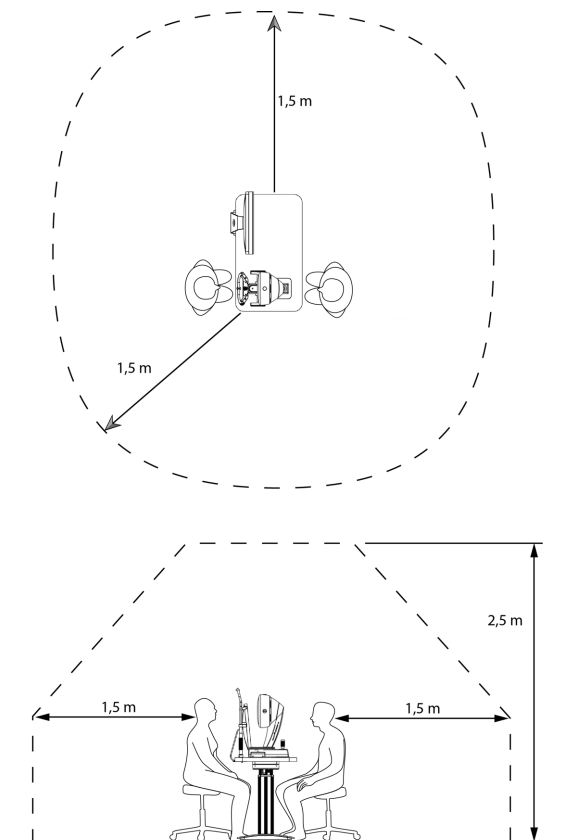

Fig. 4-1: Patient environment

Information about the operation of an ME system

The Pentacam® AXL Wave and a connected computer form a medical electrical system (ME system) according to IEC 60601-1. If you connect additional devices, such as, for example a printer, those devices become part of the ME system.

- ➔ Make sure that all devices of the ME system meet the requirements of IEC 60601-1 or IEC 60950-1/IEC 62368-1.

Instructions for Operation

- Before first use: Let OCULUS or an authorized dealer train you in the operation of the Pentacam® AXL Wave.
- Never operate a damaged Pentacam® AXL Wave.
- Only operate the Pentacam® AXL Wave with the original accessories supplied by us and only when the unit is in technically perfect condition.
- Do not cover the ventilation openings.
- Do not touch the patient and the device at the same time.
- Make sure that the device cannot tip over by leaning against it or sitting on it.
- Do not put the Pentacam® AXL Wave, including rechargeable battery or cable, down onto devices that produce heat, heaters (for example radiators), microwaves or similar.
- Only operate the device if you have understood the operating instructions.



Caution

The light emitted from this instrument is potentially hazardous. The longer the duration of exposure and the greater the number of pulses, the greater the risk of ocular damage. Exposure to light from this instrument when operated at maximum output will exceed the safety guideline after 48 treatments.



Instructions for Laser Use

Attention

Risk of personal injury or material damage due to invisible laser radiation
 The Pentacam® AXL Wave contains a Class 1 laser according to IEC 60825-1: 2014. It is an encapsulated laser system. When the Pentacam® AXL Wave cover is opened, you may be exposed to invisible, Class 3R (5 mW) laser radiation.

- Never open the unit.
 - For authorized service personnel only: When doing maintenance jobs, avoid looking directly into the laser beam.
-

Instructions for Maintenance

In order to retain the high measurement accuracy of the Pentacam® AXL Wave OCULUS Optikgeräte GmbH recommends to perform a maintenance service every two years or after 25000 scans. A corresponding message appears, see [sec. 14.3, page 79](#). Additionally to that it is useful to accomplish a test measurement of the axial length measuring mode everyday before you start working with the Pentacam® AXL Wave.

If an error occurs which you cannot correct, label the Pentacam® AXL Wave as being "out-of-order" and contact our service department, see [sec. 18, page 84](#).

Instructions for Disassembly and Disposal

- ➔ When disconnecting electrical connections, pull on the respective plug and not on the cable itself.
- ➔ Dispose of the device according to legal regulations.

Instructions on Electrical Safety



Attention

Risk of personal injury or damage to property due to an incorrect level of safety

Connecting the Pentacam® AXL Wave with its non-medical electrical equipment (e.g. data processing equipment) to a medical electrical system must not result in a patient safety level below that prescribed by IEC 60601-1. If making this connection leads to the leakage current threshold being exceeded, protective measures including a circuit breaker must be in place.

- ➔ Ensure that connections with non-medical devices are made correctly.
- ➔ Only use the power adapter listed in the packing list.
- ➔ Use only a computer that meets the specifications given in this instruction manual, [sec. 19, page 86](#).

Use of a multiple socket extension cord

Risk of personal injury or material damage caused by unsafe multiple socket extension cord

If you use a multiple socket extension cord to connect the Pentacam® AXL Wave to the power supply, you must heed the following information:

- ➔ Use an extension cord that complies with the requirements of IEC 60601-1, section 16.
- ➔ Do not place the multiple socket extension cord on the floor.
- ➔ Do not use more than one multiple socket extension cord.

- ➔ Plug only the Pentacam® AXL Wave and the computer that is being used with the unit (if applicable) into the multiple socket extension cord.

If you are using a multiple socket extension chord it has to be supplied with a isolation transformer.

If you are using a new computer for the Pentacam® AXL Wave, you must have the electrical safety checked. Call OCULUS Service for this purpose.



Attention

Electromagnetic Compatibility (EMC) / Cables

Risk of personal injury or damage to property due to electromagnetic interference

Portable and mobile RF communications equipment can affect medical electrical equipment [sec. 20, page 89](#).

- ➔ Make sure that portable and mobile RF communications equipment do not cause interference.
- ➔ Recommendation: Maintain a minimum distance of 4 m. If the distance is shorter, you must ensure that the Pentacam® AXL Wave functions correctly.

4.3 Cybersecurity Instructions



The device itself was not designed to connect via a coupled computer to the internet or other network, or to portable media, as the device does not require a network or internet connection to function.

User who elect to connect the device coupled computer to the internet or other network for other purposes are responsible for ensuring that it is done so in a controlled manner.

Data responsibility:

The device itself is not designed to connect with the internet, but only with a computer. It does not require the internet to function.

Do not connect with the internet while using the device. It is considered misuse.

If you elect to connect the computer to the internet for other purposes you are responsible for ensuring data security.

Device Security

It is the responsibility of the authorized user to ensure that the Pentacam® AXL Wave device is not left unlocked, or otherwise unsecured

when not in use, to ensure that non-authorized medical, professional, or otherwise unapproved personnel are not exposed to, or gain access to, ePHI.

User Responsibility

User names or passwords must not be shared with colleagues or others, even if they are permitted by law and provider policy to view the same type of information (e.g. two operators reviewing the same patient samples).

Operators have access to patients' ePHI and must not take snap-shots, screenshots or pictures (e.g. using another device) of any information viewed through the device.

Operators should not enter identifying data into the device. All the data on the device should be de-identified and relate to the sample id and not to the patient.

Reporting Device Security or Privacy Breaches

Operators must contact their local IT department and disclose any suspected or confirmed compromised user accounts, and any other privacy or security breaches.

Recovering from Compromised Accounts or Devices

When accounts are considered compromised, devices are lost, or unauthorized access is discovered or suspected, the Healthcare Organization's IT network administrators suspend and modify the user login criteria and issue new login credentials for the user to access their account securely.

Unavailable Service

Users should report unavailable service or prohibited access to information to their local Healthcare Organization's IT department.

Precautions

→ To ensure cyber security in order to the usage of the device, the following security measures should be considered. Contact your computer administrator:

Precautions for access control of the computer

- Secure the computer with a password (for example at Windows start up).
- Choose a complex password: A good password should be at least eight characters long and are not in the dictionary. In addition to letters, it should also include numbers and special characters.
- Do not choose a name or device name for a password (for example "Pentacam").
- Change the password regularly.
- Do not note the password in an accessible location.
- Use different passwords for different users.
- Enable the screen saver and use the option for the necessity of reentering the password when exit the screen saver.

- Choose an adequate time setting for starting the screen saver if software session is inactive (e.g. 10 minutes). Adequate time setting should consider duration of examination, number of patients, time between examinations, use of other devices in the examination room, several user, etc.
- Lock the computer if you are leaving the workstation (shortcut: 'windows logo key' + 'L').

Precautions if the computer is connected to a LAN or internet network

- If you elect to connect the computer to the LAN or internet, you are responsible for ensuring data security.
- Prefer wired connections of the computer to the network.
- If you are using Wi-Fi connections nevertheless, please ensure the usage of adequate security methods (for example WPA2/AES – Wi-Fi Protected Access / Advanced Encryption Standard – with a strong network key).
- The usage of a firewall (software or hardware) is recommended.
- Heed the instructions for integration into an IT-Network ([sec. 20.5, page 98](#)).



Do not use the Pentacam[®] AXL Wave with wireless technology, for example with wireless USB (connection between device and computer)

5 Intended Use



Attention

Federal law restricts this device to sale by or on the order of a physician.

The Pentacam AXL Wave is intended to image the anterior segment of the eye which includes the cornea, pupil, anterior chamber and lens. It is indicated for the evaluation of

- corneal shape,
- condition of the lens (opaque crystalline lens),
- the anterior chamber angle,
- anterior chamber depth,
- the volume of the anterior chamber,
- anterior or posterior cortical opacity,
- the location of cataracts using cross slit imaging with densitometry,
- corneal thickness,
- axial length,
- white-to-white distance,
- optical aberrations of the eye,
- and retroillumination imaging.

The Pentacam® AXL Wave also performs calculations to assist physicians in determining the power of the intraocular lens for implantation.

Intended medical indication

The Pentacam® AXL Wave is indicated as an aid to screen several eye diseases e.g but not limited to:

- Keratoconus classification and progression
- Early ectatic diseases
- Quantification of optical corneal density
- Quantification of optical lens density
- Close angle glaucoma
- Planning support for IOLs.

The Pentacam® AXL Wave may only be used for the purpose described in this instruction manual.

➔ Heed the safety instructions listed above.

Contraindication

None known

Possible side effects

- After-image
- Headache
- Vertigo
- Tearing eyes

Intended users

Make certain that the Pentacam® AXL Wave is used exclusively in clinics and by clinical persons or eye specialists.

- who can guarantee proper handling due to their knowledge, training and practical experience.
- who have been instructed by OCULUS staff or an authorized dealer before the initial operation.

Patient group

Children from 3 years up to geriatric patients. No restrictions on weight, health and condition

6 Device Description

6.1 Overview of the device components



- 1 Ventilation opening
 - 2 Measuring window
 - 3 Camera opening
 - 4 On/Off Switch with indicator light
- Fig. 6-1: Device components

- 5 Y-cable connector
- 6 Cross slide
- 7 Joystick
- 8 Name plate

6.2 How the Pentacam® AXL Wave works

While rotating around the eye, the Pentacam® AXL Wave captures Scheimpflug images of the anterior eye segment through varying axes. The Scheimpflug images created during an examination are transmitted to the connected PC.

The axial length of the eye is measured and displayed by partial interferometry.

Scheimpflug images can be captured at two seconds.

Up to 138,000 genuine height values are measured and analysed from the Scheimpflug images.

The Scheimpflug images are the basis for the height data which are used to calculate a mathematical 3D model of the anterior eye segment. At same time any eye movements are recorded and taken into account.

A quality specification (QS) lets you gauge the quality of the measurement taken.

The mathematical 3D model, corrected for eye movements, provides the basis for all subsequent analysis.

The topography of the front and back surfaces of the cornea, the pachymetry and the densitometry are calculated and displayed from limbus to limbus for the entire surface of the cornea.

An analysis of the anterior chamber provides the basis for calculating the chamber angle, chamber volume and chamber depth.

Densitometry of the cornea and lens automatically produces quantified values.

Colour images displayed on the screen show the results of the measurement.

A rotatable 3D model displays the front and back surfaces of the cornea, the iris and the lens.

Wavefront measurement uses a Hartmann Shack aberrometer to detect the low and high order aberrations of the entire eye. The aberrations of the cornea, the crystalline lens and the objective refraction are calculated from this measurement.

Retroillumination can be used to show opacities of the eye. Furthermore post-op check up of IOL inclination and centration can be performed.



Attention

OCULUS Optikgeräte GmbH shall not be liable in any form for further use of the data recorded by a Pentacam® AXL Wave and for the evaluations it has calculated.

7 Setup and Connection



Attention

Risk of incorrect measurements/equipment damage due to improper setup

- Before first use, make sure the installation and connection of the Pentacam® AXL Wave are completed by our service or by a professional authorized by OCULUS.
-



Note

- Do not expose the Pentacam® AXL Wave to any vibrations, shocks, contaminants, moisture, or high temperatures.
 - Handle the optical device with care.
-

- Set up the Pentacam® AXL Wave so that the power plug is easy to access. That way, you can easily disconnect it from the power supply for any repairs or maintenance work.
- Place the device so that direct light cannot affect the measurement.
- Make sure the examination is free from light reflections. To achieve this, darken the examination room.

Ambient temperature

The ambient conditions for operation are given in [sec. 19, page 86](#).

- Before installing the Pentacam® AXL Wave, consider the transport, storage and current room temperature, where the device is to be installed.

The difference between the temperature of the installation room and the storage and transport temperature should not be more than 10°C to avoid fogging of the internal optics.

- If the difference in temperature is greater than 10° C, leave the system at least for 6 hours until the temperature of the instrument has adapted to room temperature.

7.1 Electrical Connection



Attention

Electrical safety hazard

- Do not use the Pentacam® AXL Wave adjacent to or stacked with other equipment.
- If you have to use the Pentacam® AXL Wave adjacent to or stacked with other equipment, verify the correct operation of the Pentacam® AXL Wave.
- Only use the power adapter listed in the list, [sec. 20.1, page 89](#).
- If you use a multiple socket to connect the Pentacam® AXL Wave: Use a multiple socket that complies with the requirements of IEC 60601-1.
- Do not place the multiple socket extension cord on the floor.
- Do not use more than one multiple socket extension cord.
- Plug only the Pentacam® AXL Wave and the computer that is being used with the unit (if applicable) into the multiple socket extension cord.
- Use a socket with a protective earth connection which is fully operating.



Fig. 7-1: Connecting

- Plug the connector of the Y cable into the jack and tighten the connection. Make sure that the plug is inserted in the correct position.



Note

Risk of equipment damage due to incorrect connection

If you do not connect the Pentacam® AXL Wave properly, and the connection is live, the unit can be damaged within a short period of time.

- Do not use excessive force when connecting the electrical plug.
- Pay attention to the specifications on the nameplate.

If the electrical plug is damaged, contact our service department or an authorized dealer to repair the damage.

- Firmly tighten the connection.
- Connect the Y-cable to the PC/laptop and the power adapter.

7.2 Switching On



Attention

Risk of incorrect measurements due to improper setup

Before taking measurements, the Pentacam® AXL Wave has to be switched on, at least for one hour.

- The first step is to switch on the PC or laptop.
- Then turn on the Pentacam® AXL Wave with the on/off switch (position ON). The LED on the switch lights up green, [fig. 7-1, page 20](#).

7.3 Switching Off

- Close the Pentacam® AXL Wave program and close the Patient Data Management.
- Shut down the Windows operating system.
- Turn the Pentacam® AXL Wave off with the on/off switch (OFF position)

7.4 Software Installation on separate PCs

The Pentacam-Software is network compatible. This makes it possible to install the Pentacam® AXL Wave Software on several PCs, connected in a local network.

Make sure, that all PC in a network do have the same Pentacam® AXL Wave software version installed.

A Floating License Key is part of every Pentacam® AXL Wave shipment. Please ensure a proper installation based on the Manual for the Floating License Key.

This allows an interactive parallel evaluation of the Pentacam® AXL Wave exams based on the released optional software packages and modules.

The demo examinations included can be viewed on every computer having the Pentacam® AXL Wave software installed.

For more detailed information contact your authorized dealer or our service department.

8 Patient Data Management

8.1 Starting Patient Data Management

You can enter and use the patient data by the patient data management. After you have switched on the PC, it first loads the operating system.

➔ Click the Pentacam® AXL Wave icon.

The user interface for the Patient Data Management appears.

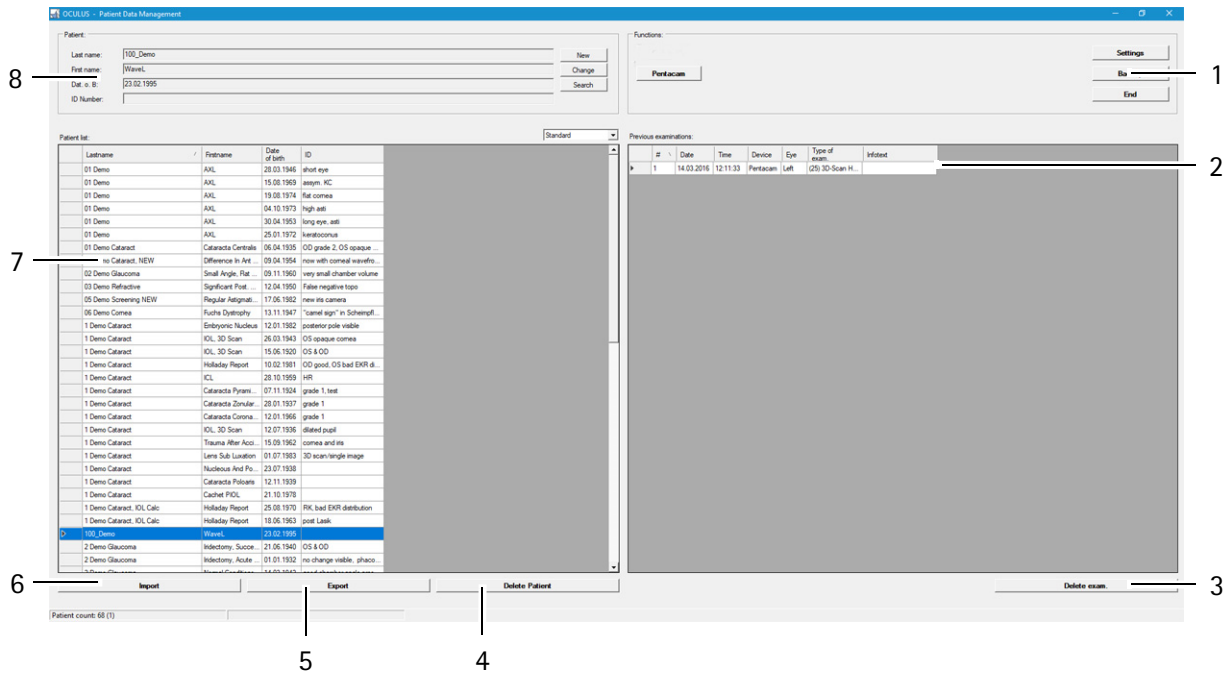

- 1 "Functions" group box
- 2 Previous examinations
- 3 [Delete exam.] button
- 4 [Delete Patient] button

- 5 [Export] button
- 6 [Import] button
- 7 Patient list
- 8 Patient data group box

Fig. 8-1: Patient Data Management user interface



To get to the Pentacam® AXL Wave program, you must first enter a new patient (8) or select an existing patient from the patient list (7).

For more information on Patient Data Management, refer to the [sec. 12, page 66](#).

8.1.1 Entering a New Patient

- ➔ Press the [New] button to enter a new patient in the Patient Data Management system.
- ➔ Enter the patient's last name, first name and date of birth in the patient window.

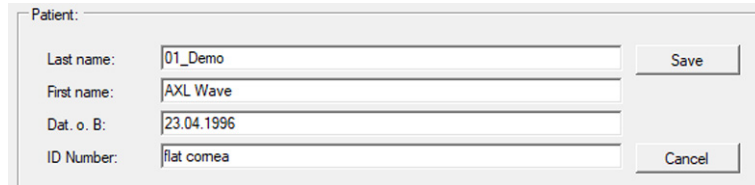

The screenshot shows a window titled "Patient:" with four input fields and two buttons. The fields are: "Last name:" with "01_Demo", "First name:" with "AXL Wave", "Dat. o. B:" with "23.04.1996", and "ID Number:" with "flat cornea". The "Save" button is located to the right of the "Last name" field, and the "Cancel" button is to the right of the "ID Number" field.

Fig. 8-2: Entering patients

Optionally you can enter an ID number for the patient.

- ➔ To save the data you entered, click [Save].
- The patient you have just entered now appears in the patient list.

8.1.2 Selecting an Existing Patient

The patient data list on the left-hand side of the screen displays all previously examined patients in alphabetical order.

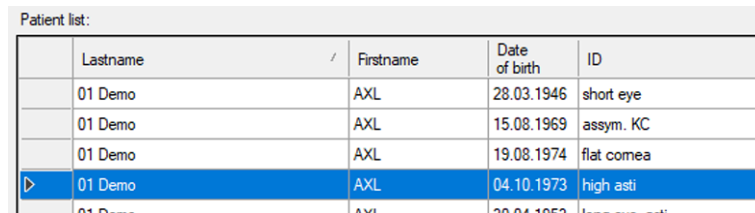

Patient list:				
	Lastname	Firstname	Date of birth	ID
	01 Demo	AXL	28.03.1946	short eye
	01 Demo	AXL	15.08.1969	assym. KC
	01 Demo	AXL	19.08.1974	flat cornea
▶	01 Demo	AXL	04.10.1973	high asti
	01 Demo	AXL	20.04.1959	high asti

Fig. 8-3: Patient list

- ➔ Choose [Search] to quickly find the patient you are looking for in the list.
- ➔ Enter the patient's name or the first letter of the name in the "Last name" field.

Alternatively, you can search for the patient using an ID number, first name or date of birth, assuming that one was assigned when the patient was first recorded.
- ➔ In the list that appears, click the entry you were searching for to transfer the patient's name to the patient window. This also brings up a list of any previous examinations for that patient in the examination window (bottom right side).
- ➔ Click on "End Search" to finish that process. The respective patient is still highlighted in blue.

Extended Patient Search: [Extended] Checkbox

➔ Click on the [Extended] checkbox.

The screen displays additional search parameters which reference previous examinations. Proceed as for the input of a patient name.

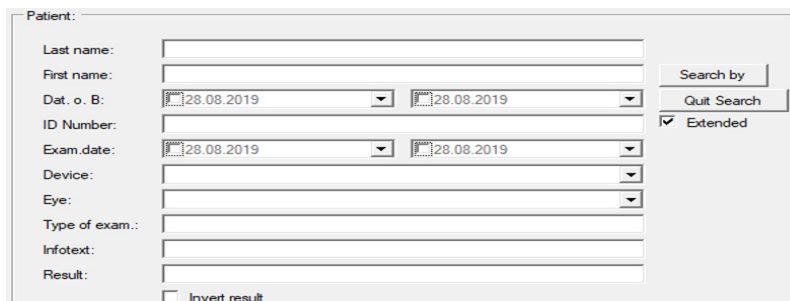

The screenshot shows a search form titled 'Patient:'. It includes the following fields and controls:

- Last name: [Text input]
- First name: [Text input]
- Dat. o. B: [Date dropdown] [Date dropdown]
- ID Number: [Text input]
- Exam.date: [Date dropdown] [Date dropdown]
- Device: [Dropdown menu]
- Eye: [Dropdown menu]
- Type of exam.: [Text input]
- Infotext: [Text input]
- Result: [Text input]
- Invert result
- Search by: [Button]
- Quit Search: [Button]
- Extended

Fig. 8-4: Advanced search

8.2 Starting the Pentacam® AXL Wave Software

Switching from Patient Data Management to the Pentacam® AXL Wave program:

➔ After selecting a patient: Press the [Pentacam] button to start the Pentacam® AXL Wave program (*fig. 8-1, page 23*)

or

➔ Double-click the selected patient name or an examination to start the Pentacam® AXL Wave program.



Proceed an axial length test measurement if a message appears, *sec. 13, page 71*.

If you do not proceed a test measurement, it will be stored in the Pentacam® AXL Wave program.

9 Using the Pentacam® AXL Wave Program

If no error message appears after starting the software with the device connected and switched on (for example component failure, camera not detected, missing references data, etc.), the device is safely ready for operation.



Note

The Pentacam® AXL Wave program is not to be used to dictate therapy without professional correlation with other clinical findings and diagnostic tests.



As this instruction manual focuses on the Pentacam® AXL Wave operating concept, the description of Pentacam® AXL Wave program functions is limited to starting the measuring process and loading previous examinations. The user guide contains detailed information on the functions of the Pentacam® AXL Wave program.

9.1 Blank Overview Display

After starting the Pentacam® AXL Wave program this display appears.

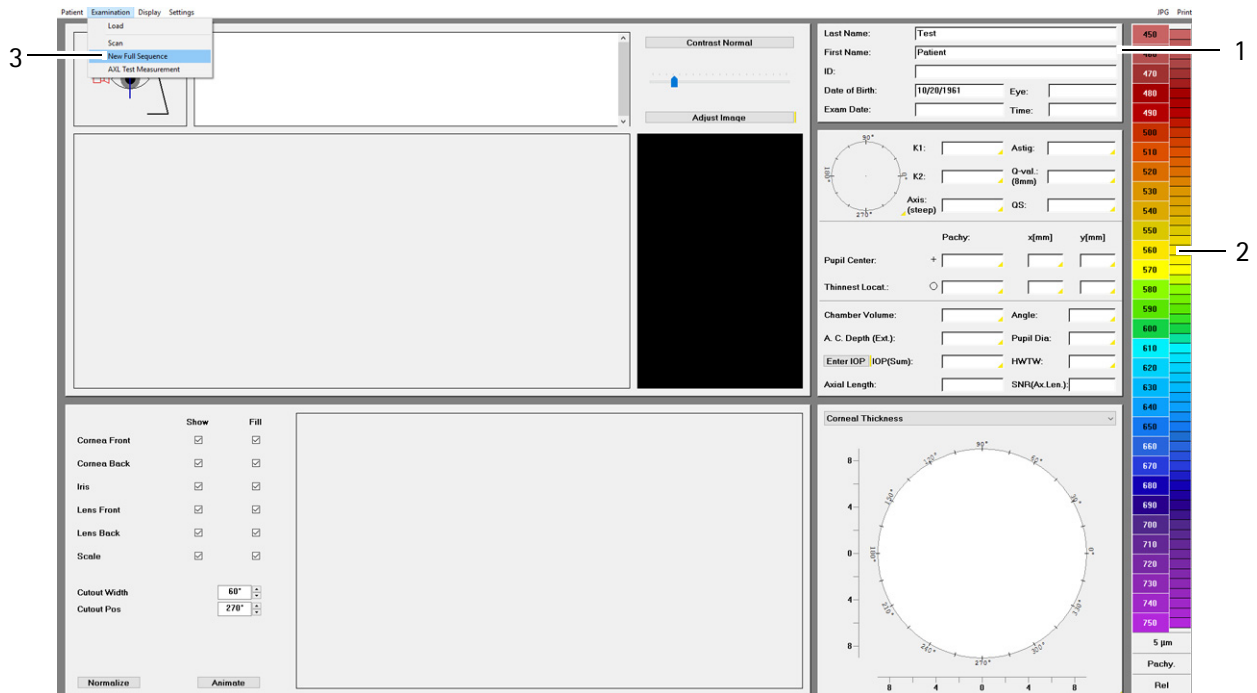

1 Patient data

3 Examination menu

2 Colour bar

Fig. 9-1: Blank overview display

9.2 Starting an examination

An examination sequence with the Pentacam® AXL Wave combines the following modi:

- total wavefront aberrometry
- retroillumination
- axial length
- Scheimpflug tomography
- ➔ Select the [Examination] tab and click [New Full Sequence] to start the full sequence examination.



You can perform single scans for each examination mode, for example to check values after a surgery, *sec. 11.7.1, page 60*.

9.3 Pentacam® AXL Wave Overview Screen

After starting the full sequence program this display appears.

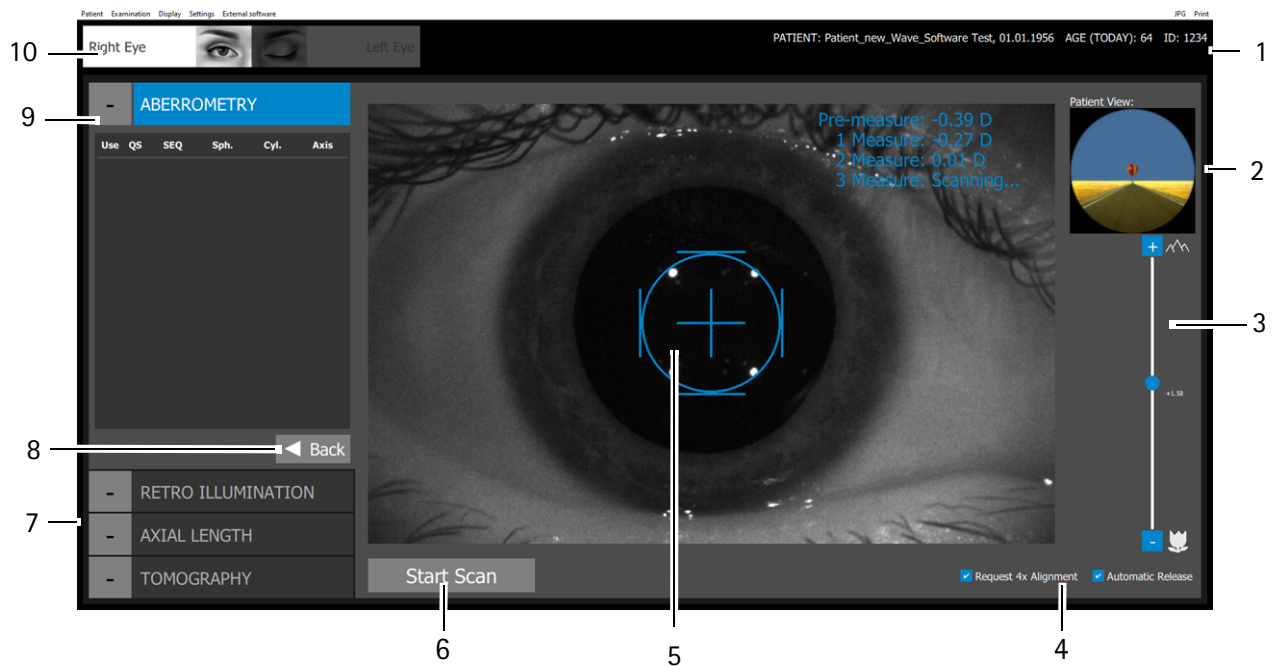

- | | |
|---|--|
| 1 Patient data | 6 [Start Scan] button |
| 2 Patient view | 7 Overview examination modes |
| 3 Slider for fixation target | 8 [Back] button |
| 4 Checkboxes for respective measurement | 9 Current examination mode |
| 5 Overview image with adjusting aid | 10 Display of currently examined eye (R/L) |
- Fig. 9-2: Scan screen (example "Wavefront")

- Patient data (1).

- The patient view shows the respective image or fixation target, where the patient has to look where the patient has to look at during the measurement (2).
- The slider of the fixation target (3) adjusts itself automatically based on the objective refraction to the respective distance.
- It depends on the measurement mode which checkboxes (4) are displayed.
- The Overview Image (5) with a cross hair as an adjusting aid supports the examiner to align the Pentacam® AXL Wave correctly to the patients eye. After the alignment is finished the Pentacam® AXL Wave releases the measurement automatically.
- In cases where no automatic measurement release is possible for example unstable fixation, click the [Start Scan] button (6) to activate the manual measurement.
You can also use the Return key.
- You can change the mode of the examination (7). Click the [Back] button (8) to go to the prior examination mode.
- The current examination mode (9) shows the information whether the data can be used to analyze the data, the QS value and measurement specific results such as axial length.
- The eye currently being examined is detected automatically and displayed (10).

Information on the single measurements

Each measurement is listed and rated.

1 Use	2 QS	SEQ	Sph.	Cyl.	Axis
<input type="checkbox"/>	✘	+2.37 D	+2.93 D	-1.11 D	91.7°
<input type="checkbox"/>	✘	+2.43 D	+2.92 D	-0.99 D	89.1°
<input checked="" type="checkbox"/>	✔	+2.43 D	+2.97 D	-1.07 D	88.2°

1 "Use" column

2 "QS" column

3 Values, depending on current mode

Fig. 9-3: Example Aberrometry: Objectiv erefraction parameter

- **Use (1):** Measurement is used for the evaluation.
If the the QS value of the respective measurement is green and reads ok, click the checkbox to use the data for the evaluation in the full sequence analysis. The full sequence analysis is a comprehensive summary display which includes the data from all four measurements/pictures which where done in one full sequence routine
Use only one measurement for the full sequence examination.

- **QS (2):** Quality Specification factor including different parameters depending on mode. If the value
 - is green and reads OK, the measurement is correct and can be used for the evaluation of the examination.
 - is yellow, you may want to repeat the measurement.
 - is red, you have to repeat the measurement.

9.4 Loading previous examinations

- ➔ Select the menu item [Examination] and click [Load].
The dialog box "Load Examination" appears.
- ➔ Make a selection by clicking the required examination.
- ➔ Confirm your selection by clicking [OK], or by double clicking.
The Pentacam® AXL Wave program will load the examination you have selected.

9.5 Helpful information



The Pentacam® AXL Wave program provides helpful assistance. This can be found by clicking on the yellow mark.

This symbol appears for some measured values.

- ➔ Click on this symbol to show the corresponding message.
You must check the corresponding measured value.

10 Information on Modes



The user guide contains detailed information on the settings and default settings of the Pentacam® AXL Wave.

An examination sequence with the Pentacam® AXL Wave combines the following modi:

- total wavefront aberrometry
- retroillumination
- axial length
- Scheimpflug tomography

The program automatically guides you through the examination routine. But you can access each examination mode separately, see [sec. 11.7, page 59](#).

10.1 Information on Aberrometry Mode

Total wavefront aberrometry allows for objective assessment of overall refractive error of an eye before and after cataract and refractive surgery.

10.2 Information on Retroillumination Mode

Implemented retroillumination enables a check of the inclination and centration of IOLs, especially toric IOLs.

10.3 Information on Axial Length Mode

Contact-free optical biometry from the corneal surface to the retina is performed for IOL power calculation:

Type of examination	Examination mode	Images	Automatic measurement	Notes
Axial length	AXL	6	Yes	Take care of the correct eye status.

Fig. 10-1: Information on axial length mode

10.4 Information for Tomography Mode

Based on 25 or 50 captured Scheimpflug images and resulting 3D model, the anterior eye segment can be measured, displayed and analyzed for different applications like early ectasia screening, cataract evaluation etc.

Type of examination	Examination mode	Images	Automatic measurement	Notes
Topography	3D scan	25-50	Yes	
Pachymetry	3D scan	25-50	Yes	
Analysis of the anterior chamber	3D scan	25-50	Yes	Do not apply mydriatic drops.
Densitometry	3D scan	25-50	Yes	Use the same number of images to enable a progress check, apply mydriatic drops.

Fig. 10-2: Information for Tomography Mode

11 Measuring Procedure

This section describes the procedure how

- to prepare a measurement, [sec. 11.1, page 32](#)
- to measure the wavefront aberration, [sec. 11.2, page 36](#)
- to use the retroillumination mode, [sec. 11.4, page 42](#)
- to measure the axial length, [sec. 11.4, page 42](#)
- to perform a tomography scan of the anterior segment of the eye, [sec. 11.5, page 48](#)

You can also carry out a single measurement, [sec. 11.7, page 59](#)



Attention

Risk of incorrect measurement due to incorrect use

- ➔ Before first use: Let OCULUS or an authorized dealer train you in the operation of the Pentacam® AXL Wave.

Risk of incorrect measurements due to improper setup

- ➔ Before taking measurements, the Pentacam® AXL Wave has to be switched on, at least for one hour.

Risk of incorrect measurement caused by little movements of the patient

Proper patient alignment may be affected by small movements from a rolling stool used during measurement.

- ➔ Perform a Pentacam® AXL Wave scan only if the patient sits in a stationary chair. In cases of wheel chairs lock the brakes.

11.1 Preparing the Measuring Procedure

Default settings

- ➔ Make sure that the desired measurement mode is activated.
- ➔ Adjust the table height.
- ➔ Check that
 - fresh paper has been put onto the chin rest or the chin rest has been cleaned and disinfected, [sec. 14, page 77](#).
 - the forehead rest has been cleaned and disinfected after each examination, [sec. 14, page 77](#).
 - the lens in front of the camera and the acrylic glass are clean.
- ➔ Ask the patient to place his or her head on the chin and forehead rest.
- ➔ Do not touch the patient and the Pentacam® AXL Wave simultaneously.
- ➔ Select the [Examination] tab and click [New IOL measurement sequence].

Rough adjustment

- ➔ The black ring marking between the chin rest and the forehead rest (1) should be used for gauging the required height of the patient's eyes.



1 Marking (black ring)

2 Twist grip

Fig. 11-1: Rough adjustment of the chin and forehead rest

- ➔ Adjust the patient's eye level using the twist grip (2).
The patient is positioned correctly when chin and forehead touch the rests and the eyes are leveled with the marking.



If you adjust the chinrest for a small head (for example: a child's head), the test eye will stop the chinrest. Swing the test eye to the side and then adjust the chinrest.

- ➔ Example of a rough adjustment for the right eye: Move the cross slide (1) until the marking at the end of the cross slide roughly coincides with the circle R (4) on the sliding plate.

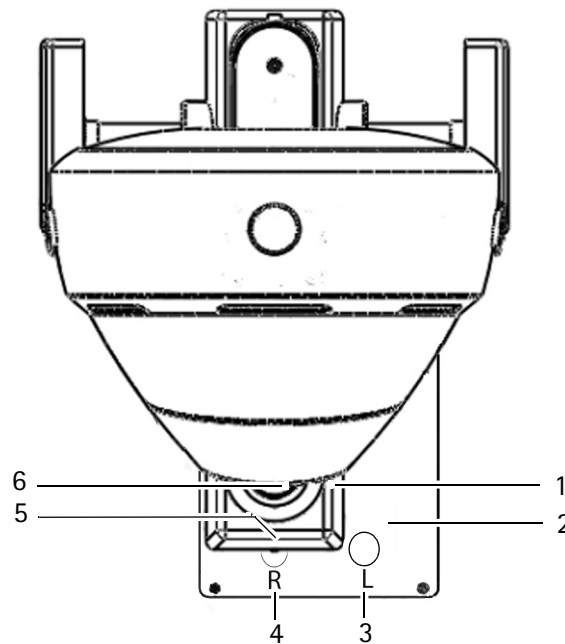

- | | | | |
|---|---------------|---|----------------------------|
| 1 | Cross slide | 4 | Right marking |
| 2 | Sliding plate | 5 | Marking on the cross slide |
| 3 | Left marking | 6 | Joystick |

Fig. 11-2: Markings on the cross slide

- ➔ Look at the patient's eye you are examining from one side and make sure that his/her eye is in front of the measuring window.
- ➔ If necessary, adjust the position of the cross slide to the left or right.

Darkening the room/dark sheet

- ➔ If the lighting in the examination room has not been turned down or switched off, use the dark sheet supplied to cover the patient and the Pentacam® AXL Wave.
- ➔ Advise the patient to look at the respective fixation target/picture.

Fine adjustment

➔ Make any fine adjustments required based on the information in the adjustment window.

Example (with blue arrows): distance and position to patient's eye is not correct.

➔ Move the joystick backwards and to the left.

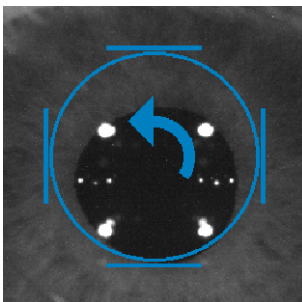
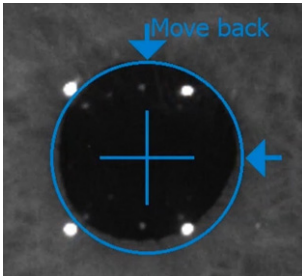

Example (with blue arrows): Move or rotate the joystick in the specified direction.

➔ Turn the joystick counter clockwise.

Arrow	Camera movement	Joystick movement
➔	right	Move the joystick to the right
➔	left	Move the joystick to the left
⬆	forwards	Move the joystick toward the patient
⬇	backwards	Move the joystick away from the patient
↻	up	Rotate the joystick clockwise
↻	down	Rotate the joystick counter-clockwise

When you have achieved the expected position, a blue cross will appear in the centre of the ring, surrounded by four blue lines. The Pentacam® AXL Wave will automatically start with the measurement.

Start the examination manually

Alternately you can start the measuring procedure manually.

➔ For measuring manually: Start measuring by clicking [Start Scan] or by pressing the return key.

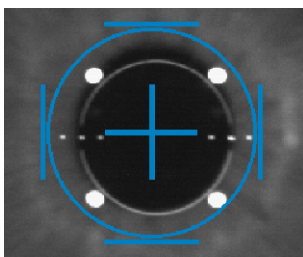

11.2 Measuring Procedure to Measure the Wavefront Aberration

➔ Prepare the measurement and adjust the patient, [sec. 11.1, page 32](#).

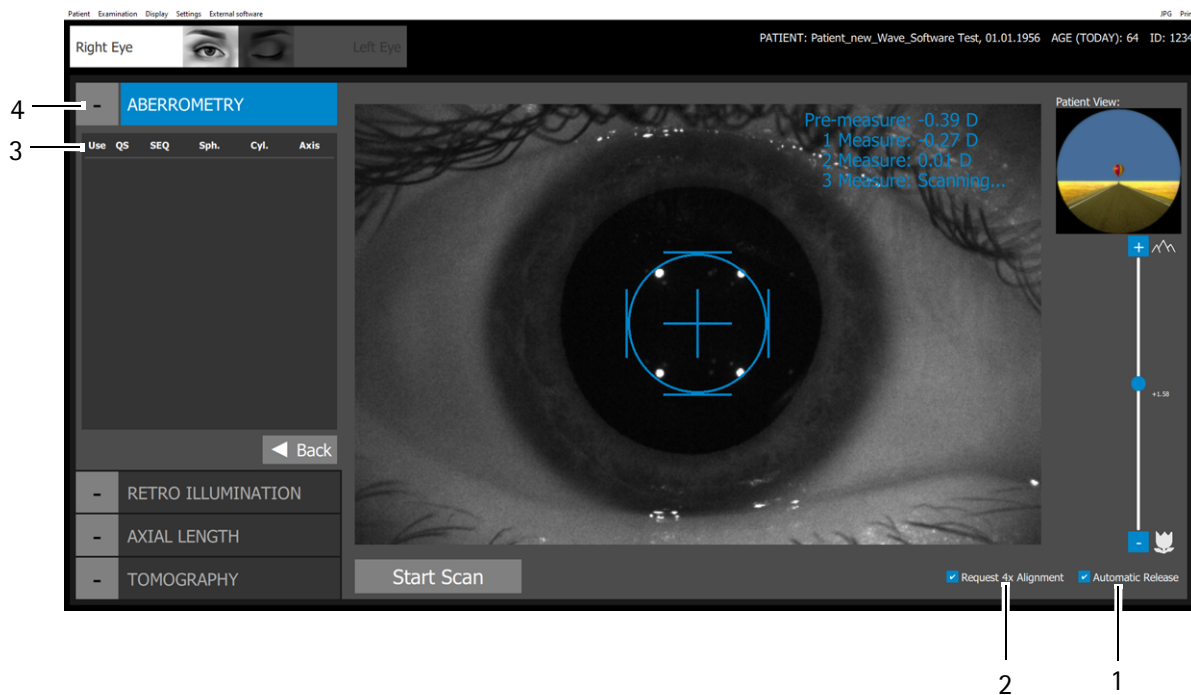

1 [Automatic Release] checkbox
2 [Request 4x alignment] checkbox
Fig. 11-3: Scan screen "Aberrometry"

3 Objective refraction parameter
4 Current examination mode

Measuring of the wavefront aberration

- ➔ Ask the patient to blink normally, take a short break and proceed with the aberrometry scan.
- ➔ Make sure that the [Automatic Release] checkbox (1) is selected, to activate the automatic measurement release. The option should be activated per default.
- ➔ Make sure that the button "Request 4x Alignment" (2) is activated. If "Request 4x Alignment" is activated, the aberrometry measurements starts only if the patient is fixating correctly. The measurement starts automatically. "Request 4x Alignment" deactivated means: The measurements are performed without any interruptions.
"Request 4x Alignment" is activated by default. Only deactivate "Request 4x Alignment" if the patient cannot fixate properly.

- ➔ Move the image with the cross towards the patient until the four infrared LEDs are clearly seen.

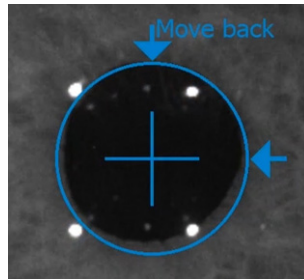

Fig. 11-4: Adjustment

You can use the adjusting aid of the fine adjustment alternatively, see ["Fine adjustment" page 35](#).

- ➔ Shortly before you have reached the final position ask the patient to widen his or her eye and not to blink.
The tentative final position of the camera is reached when the four bars frame the blue circle.
The Pentacam® AXL Wave triggers the measurement of the aberrometry and the retroillumination automatically.
- ➔ Follow the instructions on the screen and then continue with the measurement of the axis length.

Objective refraction parameter (3)

Use	QS	SEQ	Sph.	Cyl.	Axis
<input type="checkbox"/>	✘	+2.37 D	+2.93 D	-1.11 D	91.7°
<input type="checkbox"/>	✘	+2.43 D	+2.92 D	-0.99 D	89.1°
<input checked="" type="checkbox"/>	✔	+2.43 D	+2.97 D	-1.07 D	88.2°

Fig. 11-5: Objective refraction parameter

- **Use:** Activate this checkbox to use the data for the full sequence analysis. Use only one exam of each exam mode for the full sequence examination, ["Information on the single measurements" page 28](#).
- **QS:** Quality Specification value, see [sec. 11.2.1, page 38](#).
- **SEQ:** Spherical equivalent based on the wavefront refraction
- **Sph.:** Spherical power based on the wavefront refraction
- **Cyl.:** Cylindrical power based on the wavefront refraction
- **Axis:** Position of the axis based on the wavefront refraction

11.2.1 Quality Specifications and parameter for wavefront aberrometry

After you have begun measuring either automatically or manually, the Pentacam® AXL Wave program opens. The "QS" value appears in field (2).

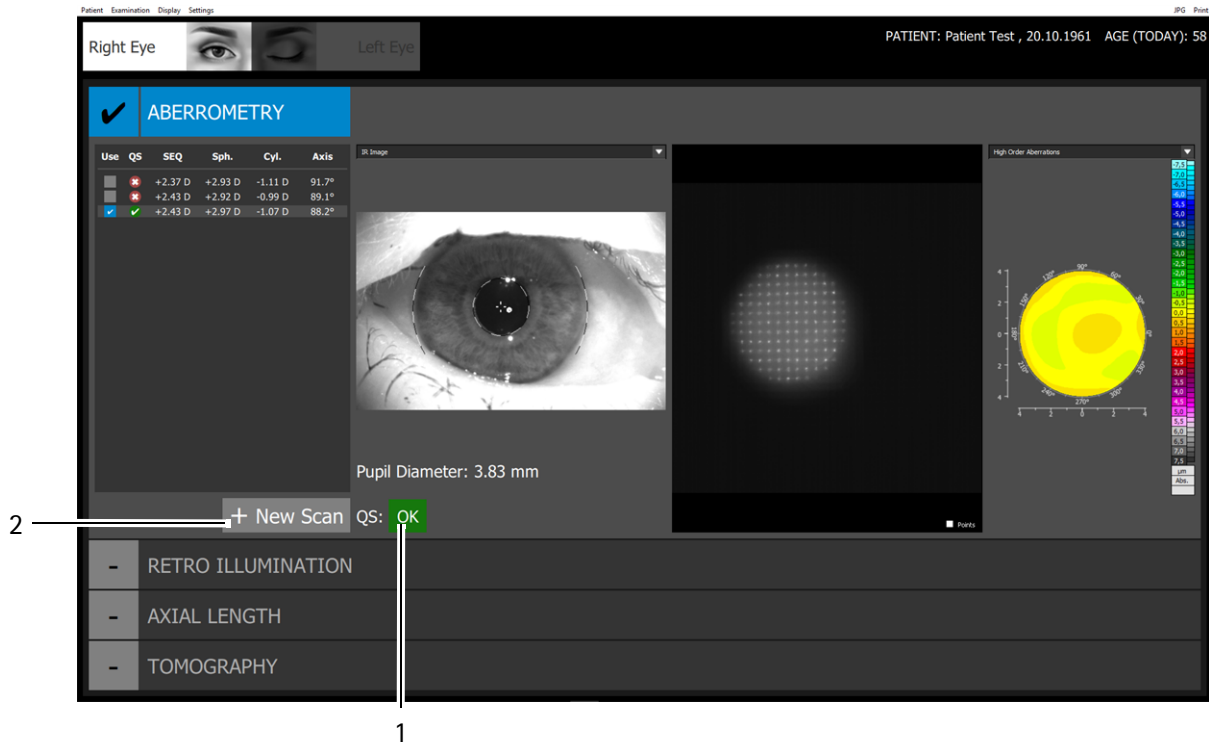

1 "QS" value

2 [+New Scan] button

Fig. 11-6: Aberrometry result display



Note

All examinations are automatically saved, regardless of the quality of the measurement taken.

QS: If the scan data (1)

- is green and reads OK, the measurement is correct and can be used for the evaluation of the examination.
- is yellow, you may want to repeat the measurement.
- is red, you have to repeat the measurement.



If the "QS" display is highlighted in yellow or red, check the QS values.

- ➔ Click on the "QS" button.
- The following dialog box appears:

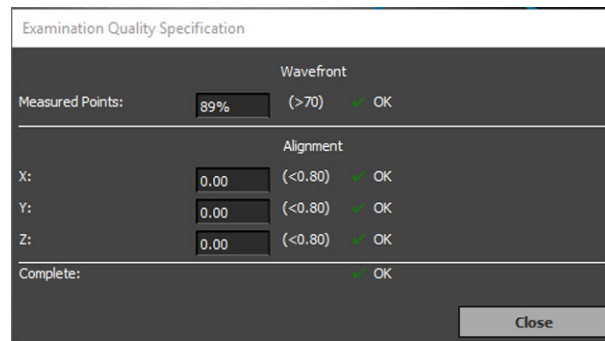

Fig. 11-7: Examination Quality Specification

- ➔ Check the measurement results.
- ➔ If you have any doubts, repeat the measurement.

Parameters

- **Measured Points:** If analyzed data is less than the permissible threshold.
- **Alignment X, Y and Z:** If one of these values exceeds the permissible threshold, you may have moved the cross slide at the moment you began measuring.
- **Complete:** The worst value of the of the QS parameters is displayed.

Terminating "QS"

- ➔ Click [Close] to return to the Pentacam® AXL Wave program.
- ➔ Terminate the current examination which has been saved.
- ➔ If required, click the [+New Scan] button (2) for a new measurement. Otherwise click on the next exam mode [Retroillumination].

11.3 Capturing Procedure for the Retroillumination

Immediately after measuring the wavefront aberration, a single retroillumination exposure is automatically carried out. Use this measurement mode for further retroillumination exposures.



Attention

You have to carry out an image capture with manual release.

➔ Prepare the measurement and adjust the patient, [sec. 11.1, page 32](#).

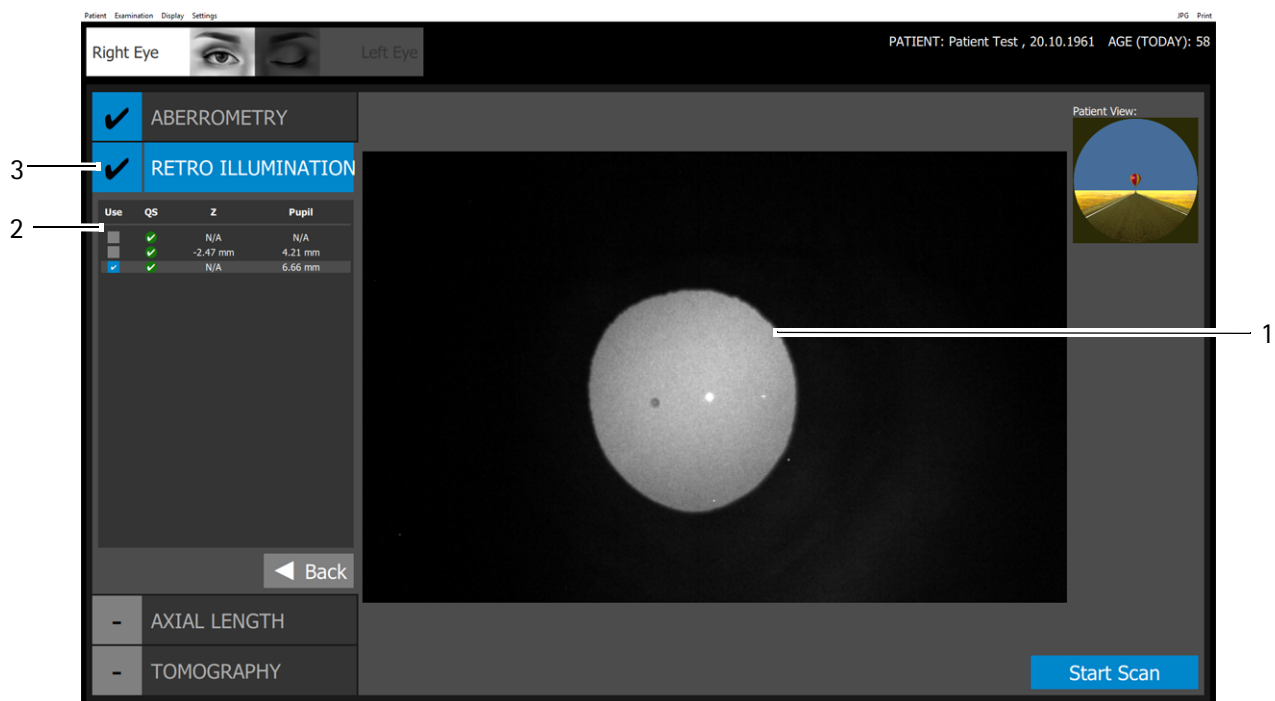

1 Pupil image during retroillumination

3 Current examination mode

2 Retroillumination parameter

Fig. 11-8: Scan screen "Retroillumination"

- ➔ Click on the [RETRO ILLUMINATION] button.
- ➔ Focus the pupil image (1) by moving the joystick, see ["Fine adjustment" page 35](#).
The tentative final position of the camera is reached when you find your point of interest.
- ➔ Shortly before you have reached the final position ask the patient to widen his or her eye and not to blink.
- ➔ Click on [Start Scan] button to capture the image of interest – for example opacities of the crystalline lens.

Retroillumination parameters (2)

Use	QS	Z	Pupille
<input type="checkbox"/>	✓	N/A	N/A
<input type="checkbox"/>	✓	-2.47 mm	4.21 mm
<input checked="" type="checkbox"/>	✓	N/A	6.66 mm

Fig. 11-9: Objective Retroillumination parameter

- **Use:** Activate this checkbox to use the data for the full sequence analysis. Use only one exam of each exam mode for the full sequence examination.
- **Z:** Distance of the device to the focus level
- **Pupil:** Diameter of the pupil

11.4 Measuring Procedure to Measure the Axial Length

Before the measurement



It is mandatory to select the correct eye status before every axial length measurement. Different eye status lead to different results for the axial length measurement, hence influence the IOL power calculation. The eye status has to be selected by the user before every AXL-Scan.

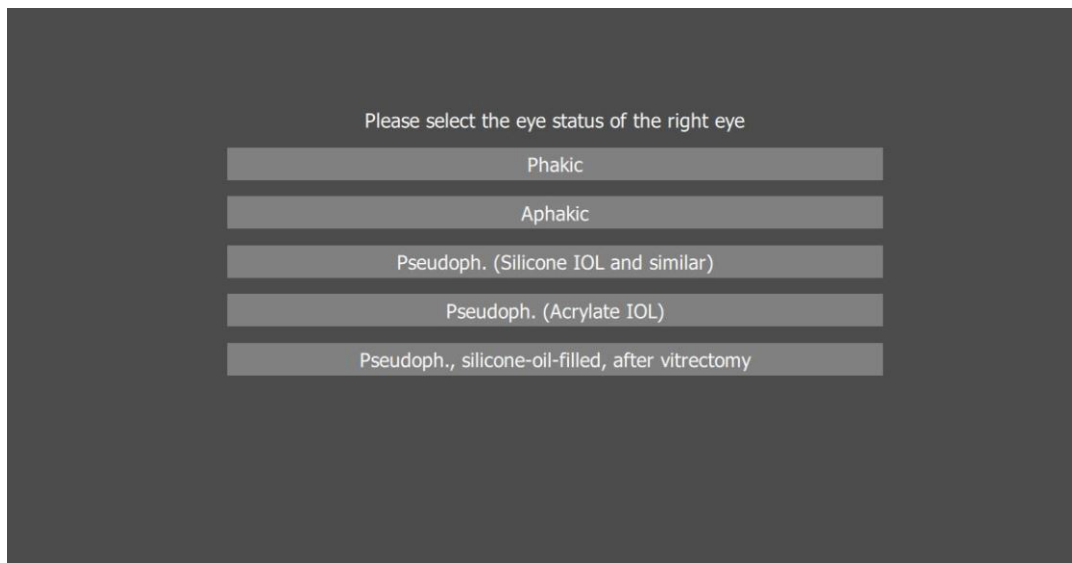

- ➔ To select the eye status click on button "Eye status" in the axial length scan mode of the full sequence measurement mode
- Phakic: Default status. Presence of crystalline lens.
- Aphakic: Absence of the crystalline lens. Correction of measured axial length by +0.200 mm
- Pseudophakic (Silicone IOL or similar): IOL of silicone or similar material implanted. Correction of axial length by +0.120 mm.
- Pseudophakic (Acrylate): Acrylat/Metaacrylate IOL implanted. Correction of axial length by +0.110 mm.
- Pseudophakic, silicon-oil filled, after vitrectomy: previous vitrectomy with a silicon-oil-filled vitreous. Correction of axial length by -0,692 mm



Attention

Risk of incorrect measurement caused by unchecked plausibility

➔ Check both eyes on plausibility.

Recommended differences between both eyes should be below:

- Axial length AXL <0,3mm
- Curvature < 0,18mm. This equals approximately in 1dpt (based on a refractive index of 1,3375)
- Difference of IOL power to reach emmetropia by same target refraction <1D

The following conditions may influence the readings of the measurement respectively make it impossible:

- Mature cataracts, opaque corneas in the optical center, severe fixation problems.

Note: In pseudophakic eyes the anterior chamber depth is not calculated correctly but it is possible to measure the anterior chamber depth in the Scheimpflug image manually [fig. 11.8, page 64](#).

➔ Prepare the measurement and adjust the patient, [sec. 11.1, page 32](#).

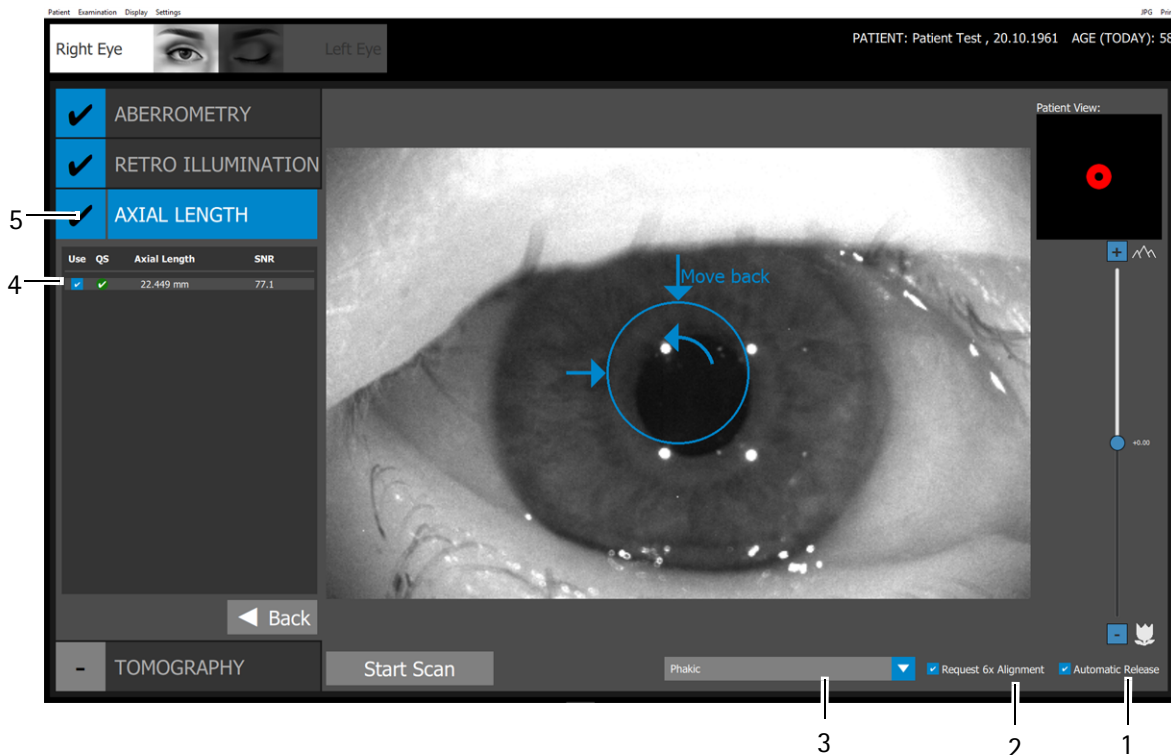

- 1 [Automatic Release] checkbox
- 2 [Request 6x alignment] checkbox
- 3 Dropdown list for eye status
- 4 Axial Length parameter
- 5 Current examination mode

Fig. 11-10: Scan screen "Axial length"

Measuring of the axial length

- ➔ Move the image with the cross towards the patient until the four infrared LED are clear.

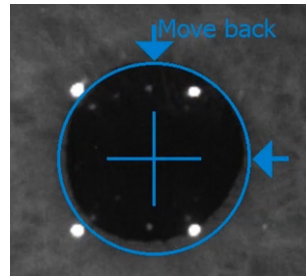

Fig. 11-11: Adjustment

- ➔ Focus the pupil image by moving the joystick, see *"Fine adjustment"* page 35.
- ➔ Shortly before you have reached the final position ask the patient to widen his or her eye and not to blink.
The tentative final position of the camera is reached when the four bars frame the blue circle.
The Pentacam® AXL Wave triggers the measurement automatically.
- ➔ Follow the instructions on the screen
- ➔ Ask the patient to blink normally, take a short break and then continue with the examination of the anterior segment of the eye (tomography scan).

During the measurement of both eyes the following messages may occur.

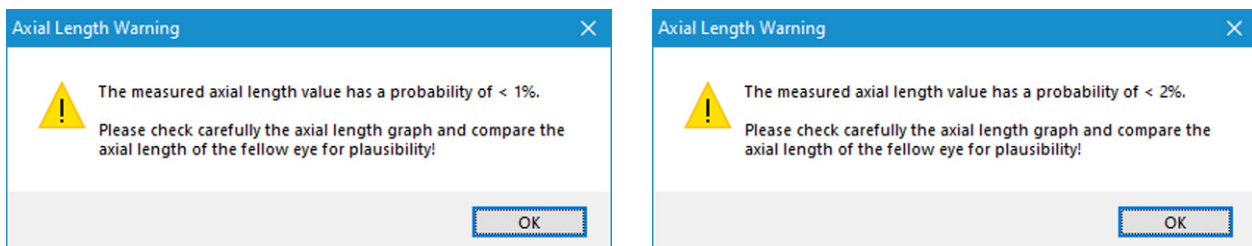

Fig. 11-12: Message: Plausibility check



Note

The axial length values do not correspond to the values of the normal population.

- ➔ Check the axial length values of both eyes.

The plausibility is marked by a yellow flagged QS value. This will be stored in the Pentacam® AXL Wave programme accordingly.



This symbol, related to the messages appears for example in the IOL calculator.

- ➔ Click on this symbol to show the corresponding message.
You must check the corresponding measured value.

If the measured axial length value has a probability of < 1%, the following message may occur.

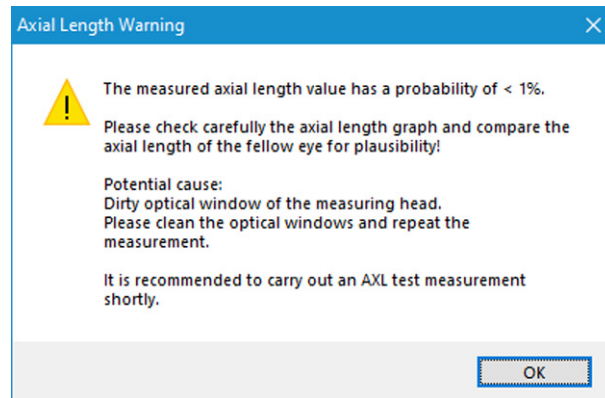

Fig. 11-13: Message: dirty optical window



Warning

Faulty measurements due to dirty window

- ➔ Clean the optical window.
- ➔ Carry out a test measurement.

If you do not carry out the test measurement, then this message will be stored in the Pentacam® AXL Wave programme accordingly marked by a red flagged QS value, for example in the IOL calculator.

- ➔ Repeat the measurement.

You must check the corresponding measured value.

- ➔ Ask the patient to blink normally, take a short break and then continue with the examination of the anterior segment of the eye (tomography scan).

Axial length parameters (4)

- **Use:** Activate this checkbox to use the data for the full sequence analysis.
Use only one measurement of each exam mode for the full sequence examination.
- **QS:** Quality Specification value, see [sec. 11.2.1, page 38](#)
- **Axial Length:** measured axial length
- **SNR:** Signal to noise ratio

11.4.1 Quality Specifications for Biometry

After you have measured one examination either automatically or manually, the Pentacam® AXL Wave program opens. The "QS" value appears in field (3).



1 Single scans with SNR values

3 "QS" value

2 Signal to noise ratio of the axial length measurement

4 [+New Scan] button

Fig. 11-14: Pentacam® AXL Wave program with "QS" display



Note

All examinations are automatically saved, regardless of the quality of the measurement taken.

- **QS:** If the AXL scan data (3)
 - reads OK, the measurement is correct and can be reproduced. SNR ≥ 6.3
 - is yellow, you may want to repeat the measurement. SNR ≥ 5.0
 - is red, you have to repeat the measurement. SNR < 5.0
- If only one single measurement out of the six is valid, its value is displayed as one single measurement, but not as a final result and QS is red, since it is only one valid measurement.
- ➔ Check the axial length measurements in the display AXL Scan carefully for possible double-peaks and a valid SNR.



If the "QS" display is highlighted in yellow or red, check the QS values.

→ Click the "QS" button.

The following dialog box appears:

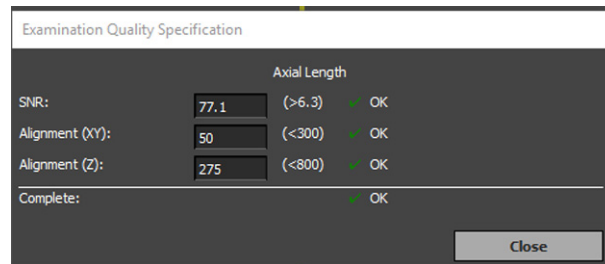

Fig. 11-15: Examination Quality Specification

→ Check the measurement results.

→ If you have any doubts, repeat the measurement.

Parameter

- **SNR:** Signal to noise ratio of the axial length measurement
- **Axial length:** The final result of the axial length is calculated only of all feasible SNR peaks. The signal to noise ratio graph of the best scan is displayed.
- **Alignment (XY) and (Z):** If one of these values exceeds the permissible threshold, you may have moved the cross slide at the moment you began measuring.
- **Complete:** The worst value of the of the QS parameters is displayed.

Terminating "QS"

→ Click [Close] to return to the Pentacam® AXL Wave program.

→ Terminate the current examination which has been saved.

→ If required, click the [+New Scan] button (4) for a new measurement. Otherwise click on the next measurement mode [Tomography].

11.5 Measuring Procedure for Tomography

➔ Prepare the measurement and adjust the patient, [sec. 11.1, page 32](#).

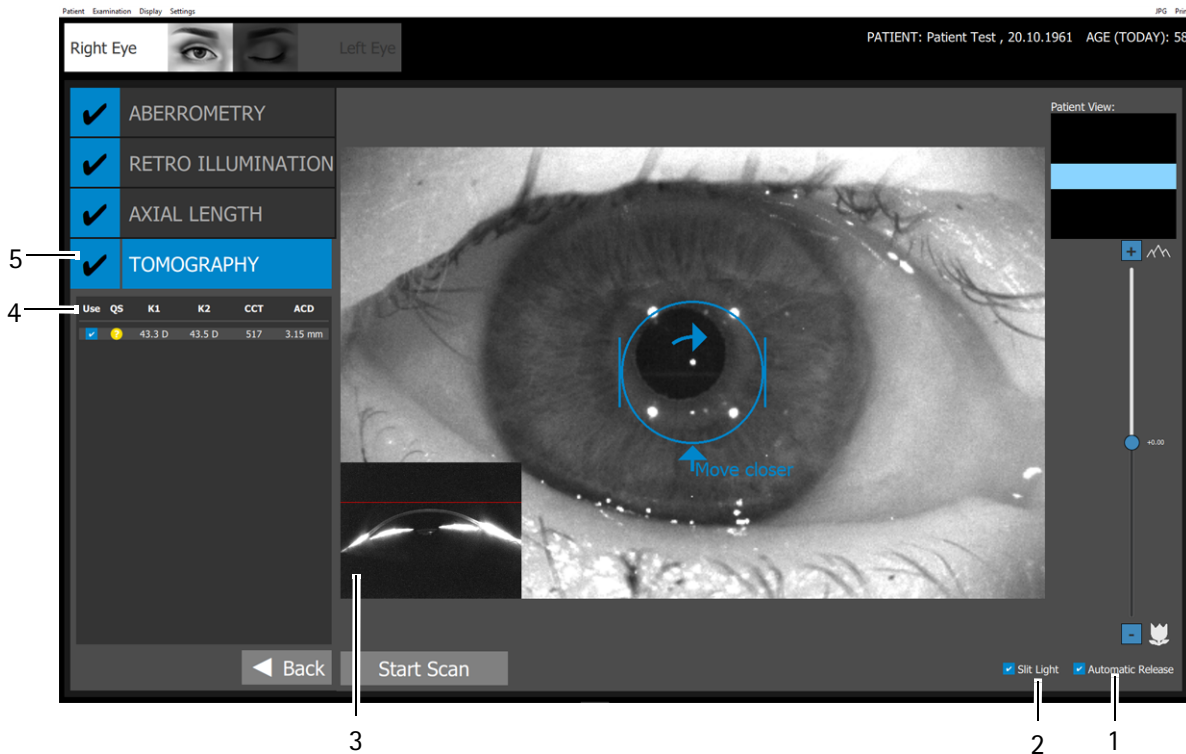

1 [Automatic Release] checkbox
 2 [Slit light] checkbox
 3 Live Scheimpflug image
 4 Tomography parameter
 5 Current examination mode
 Fig. 11-16: Scan screen "Tomography"

Measuring of the tomography

➔ Move the cross slide towards the patient until the live Scheimpflug image shows the cornea of the eye that you are examining.

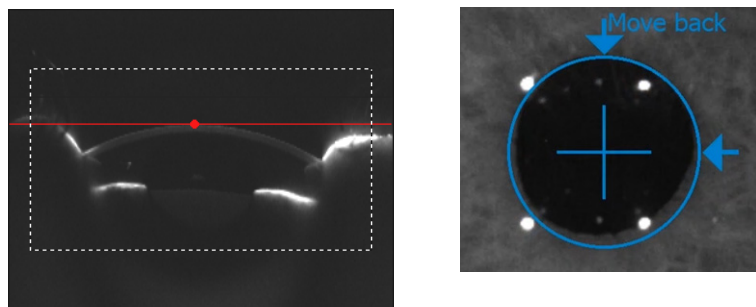

Fig. 11-17: Scheimpflug image (left) and overview image (right)

The image is sharpest when the red dot coincides with the red line in the Scheimpflug image.

- ➔ Focus the pupil image by moving the joystick towards the Pentacam® or away from it.
- ➔ Ask the patient to widen his or her eye and not to blink.

- Adjust the left/right position of the Pentacam® AXL Wave and its height setting.
Move the joystick to the left or right and rotate the joystick clockwise or anticlockwise.
The tentative final position of the camera is reached when the four bars frame the blue circle.
The Pentacam® AXL Wave triggers the measurement automatically.
- Ask the patient to remove his or her head from the rest.
- Check the measurement results by referring to the quality specifications ([sec. 11.5, page 48](#)).

Tomography parameters (4)

- **Use:** Examination can be used for the evaluation.
Click the checkbox of the respective measurement to use it for the evaluation.
Use only one measurement for the full sequence examination.
- **QS:** Quality Specification value, see [sec. 11.2.1, page 38](#)
- **K1:** Flat radius of the corneal curvature
- **K2:** Steep radius of the corneal curvature
- **CCT:** Central corneal thickness
- **ACD:** Anterior chamber depth

11.5.1 Quality Specifications for the Tomography

After measuring either automatically or manually, the Pentacam® program opens. The "QS" value appears in field (1).

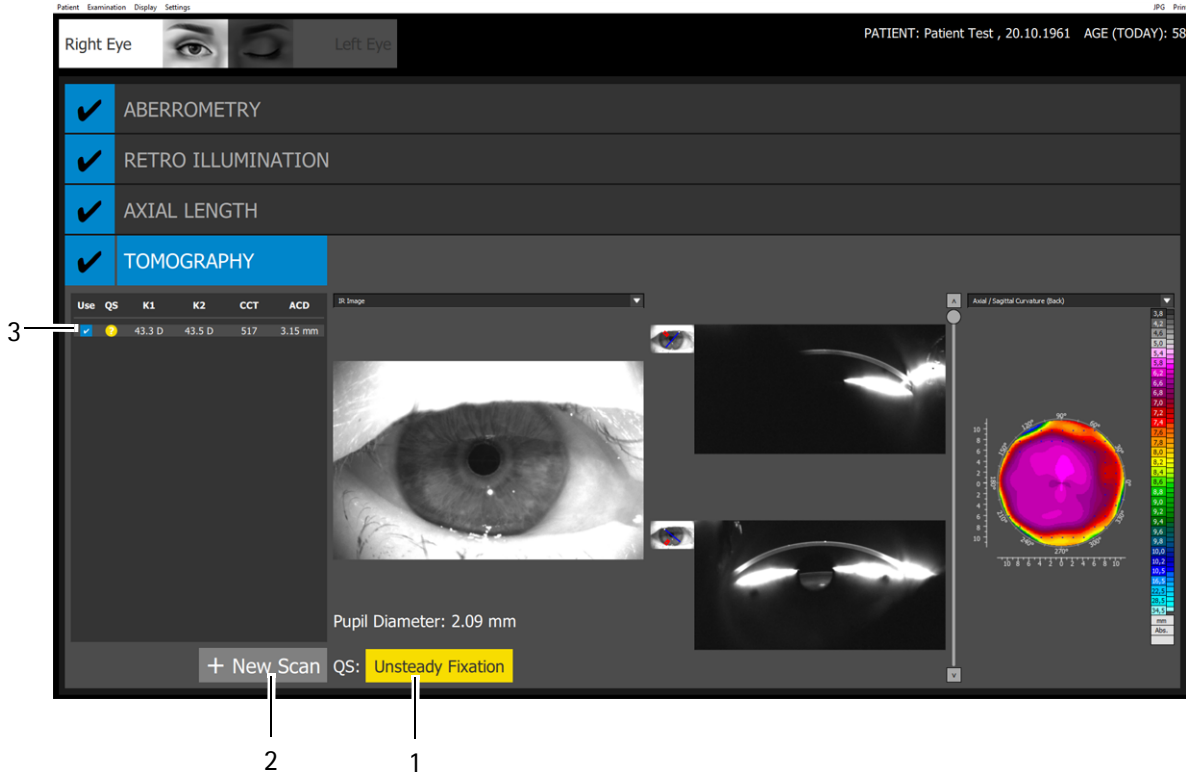

1 "QS" value

2 [+New Scan] button

3 [Use] checkbox

Fig. 11-18: Pentacam® AXL Wave program with "QS" display



Note

All examinations are automatically saved, regardless of the quality of the measurement taken.

QS: If the tomography scan data (3)

- reads OK, the measurement is correct and can be reproduced.
- is yellow, you may want to repeat the measurement.
- is red, you must repeat the measurement.



If the "QS" display is highlighted in yellow or red, check the QS values.

➔ Click the "QS" button.

The following dialog box appears:

Examination Quality Specification			
Cornea Front			
Analysed Area:	72%	(>60)	OK
Analysed Area 7.0mm:	100%	(>90)	OK
Valid Data (QF):	100%	(>80)	OK
Lost Segments:	0	(<1)	OK
Lost Seg. Continuous:	0	(<1)	OK
3D Model Deviation:	1	(<14)	OK
Cornea Back			
Analysed Area:	60%	(>50)	OK
Analysed Area 7.0mm:	100%	(>90)	OK
Valid Data (QF):	99%	(>80)	OK
Lost Segments:	0	(<1)	OK
Lost Seg. Continuous:	0	(<1)	OK
3D Model Deviation:	6	(<14)	OK
Alignment (XY):	43	(<800)	OK
Alignment (Z):	70	(<1000)	OK
Eye Movement:	53	(<150)	OK
Complete:			OK
			Close

Fig. 11-19: Examination Quality Specification

➔ Check the measurement results.

➔ If you have any doubts, repeat the measurement.

Notes on individual parameters

- **Analysed Area**

If this value is less than the permissible threshold, the patient must widen his or her eye.

- **Valid Data**

If this value is less than the permissible threshold, you have to darken the room.

- **Lost Segments and Lost Seg. Continuous**

If one of these values exceeds the permissible threshold, ask the patient not to blink while you are measuring.

- **3D Model Deviation:** deviation of measured cornea from calculated 3D model

- **Alignment (XY) and Alignment (Z)**

If one of these values exceeds the permissible threshold, you may have moved the cross slide at the moment you began measuring.

- **Eye Movement**

If this value exceeds the permissible threshold, it is possible that fixation of the patient is inadequate.

Terminating "QS"

- ➔ If required, delete the measurement if the image is inadequate.
- ➔ If required, click the [+New Scan] button (2) for a new measurement.
- ➔ Click [Close] to return to the Pentacam[®] AXL Wave program.

11.6 CSP Pro measurement

In a CSP Pro measurement, not only the cornea, but also parts of the sclera are measured. This means larger diameter contact lenses such as scleral lenses can be fitted.

Before the measurement

By default, a tomography measurement is carried out after the axial length measurement. (sec. 11.5, page 48).

- ➔ Move the CSP Pro slider (3) to the right position to activate the CSP Pro measurement.
The "Tomography" entry is hidden and the "CSP Pro" entry is displayed instead.
- ➔ Make sure that the checkbox [Slit Light] (2) is activated.
- ➔ Make sure that the [Automatic Release] checkbox (1) is selected.
- ➔ Prepare the measurement and adjust the patient, sec. 11.1, page 32.

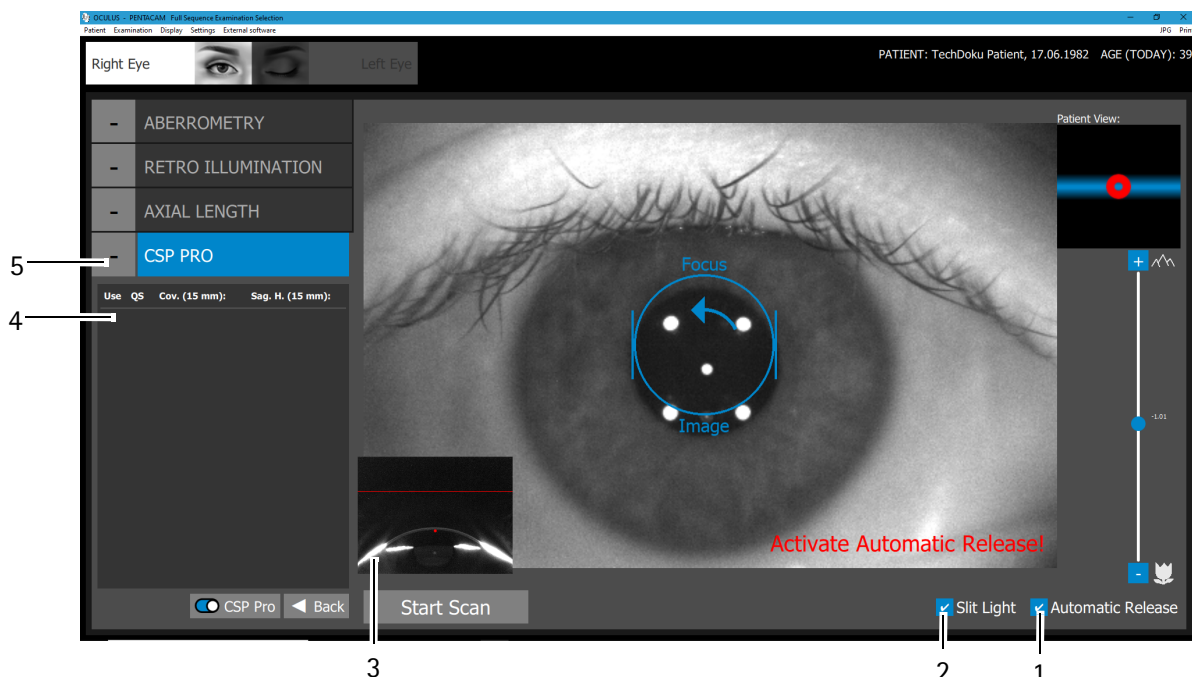

- | | |
|--------------------------------|----------------------------|
| 1 [Automatic Release] checkbox | 4 Tomography parameter |
| 2 [Slit Light] checkbox | 5 Current examination mode |
| 3 Live Scheimpflug images | |

Fig. 11-20: "CSP Pro" examination screen

Perform CSP Pro measurement

- ➔ Move the cross slide towards the patient until the live Scheimpflug image shows the cornea of the eye that you are examining.

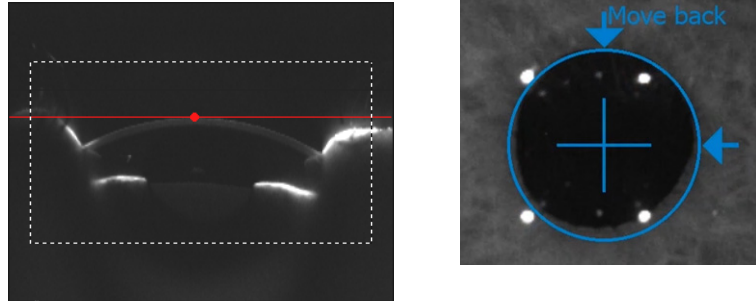

Fig. 11-21: Scheimpflug image (left) and overview image (right)

The image is sharpest when the red dot coincides with the red line in the Scheimpflug image.

- ➔ Focus the pupil image by moving the joystick towards the Pentacam® or away from it.
- ➔ Ask the patient to widen his or her eye and not to blink.
- ➔ Adjust the left/right position of the Pentacam® AXL Wave and its height setting.

Move the joystick to the left or right and rotate the joystick clockwise or anticlockwise.

The tentative final position of the camera is reached when the four bars frame the blue circle.

The Pentacam® AXL Wave triggers the measurement automatically.

- ➔ Ask the patient to remove his or her head from the rest.
- ➔ Check the measurement results by referring to the quality specifications ([sec. 11.6.1, page 55](#)).

11.6.1 Quality specification for CSP Pro measurement

After measuring either automatically or manually, the Pentacam® AXL Wave program opens. The "QS" value appears in field (2)

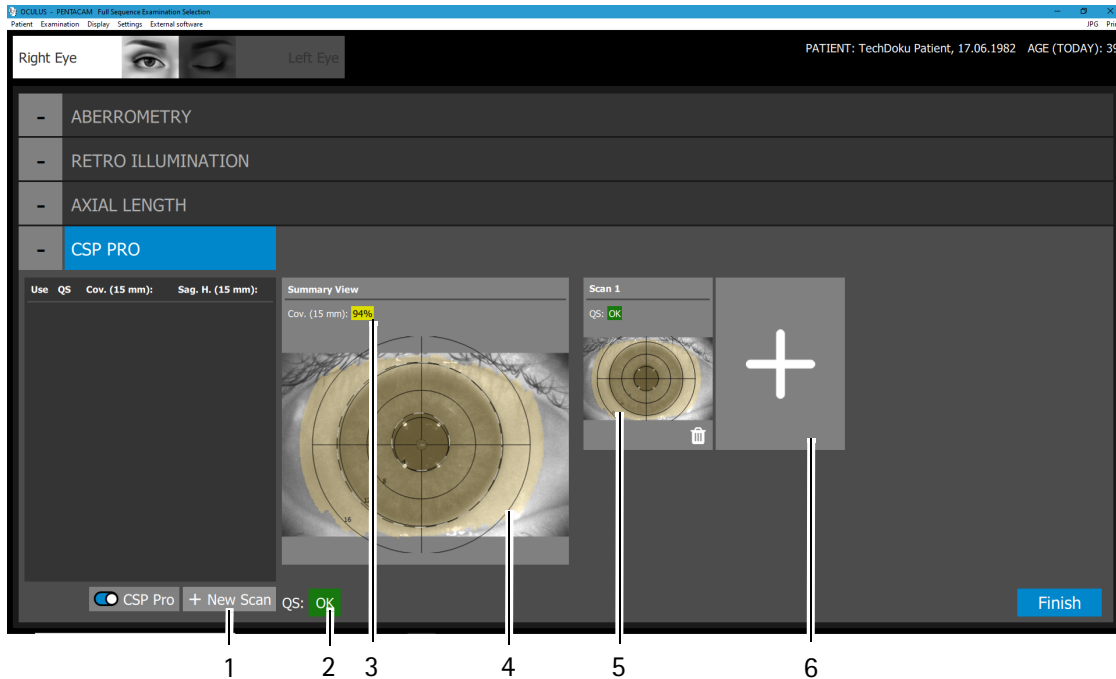

- | | |
|----------------------------------|--|
| 1 [+New Scan] button | 4 Display sum of all individual measurements |
| 2 "QS" value | 5 Individual measurements |
| 3 Value for the overall coverage | 6 [+] button |

Fig. 11-22: Results display for a CSP Pro measurement



Note

All examinations are automatically saved, regardless of the quality of the measurement taken.

If the value in the "QS" field (2)

- is green and shows OK, the measurement is correct and can be reproduced.
- is yellow, you may want to repeat the measurement.
- is red, you must repeat the measurement.

If an error message is displayed in the "QS" field, the measurement must also be repeated.

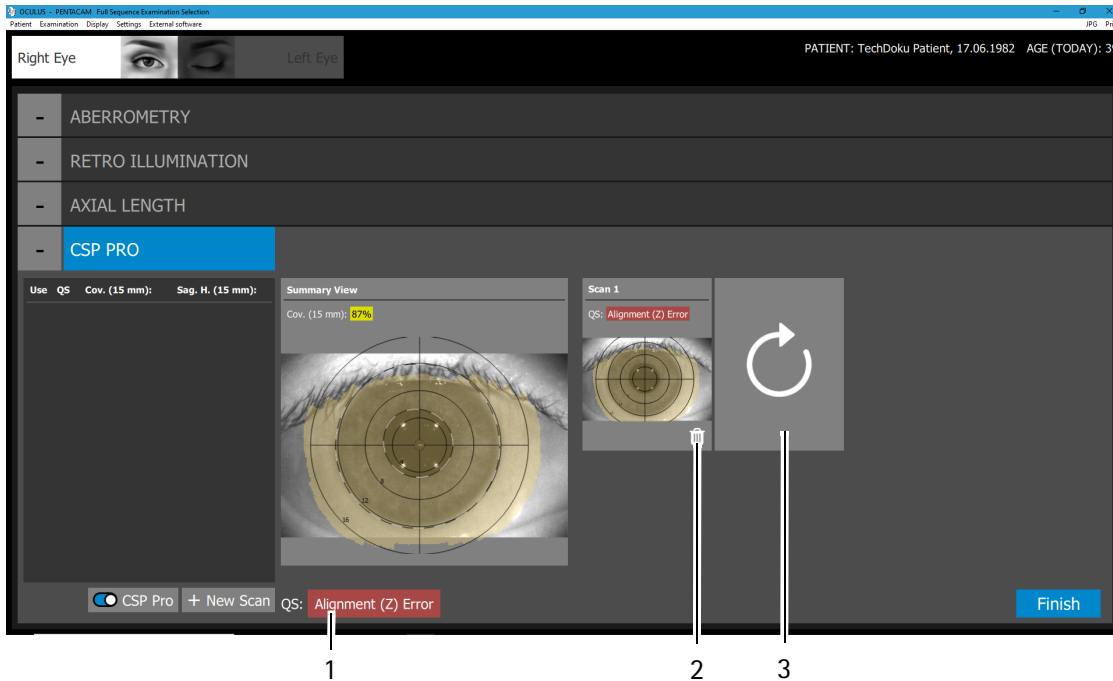

1 Error message

2 [Delete measurement] button

3 [Repeat measurement] button

Fig. 11-23: Error message after a CSP Pro measurement

11.6.2 Perform further measurements

Repeat or delete measurement

If the QS value of a measurement is not sufficient to use this for evaluation, repeat this measurement or delete it.

- ➔ Click on the [Repeat measurement] button.
The measurement is repeated and the previous measured values automatically get deleted.
- ➔ Alternatively, click the [Delete measurement] button and then carry out a new measurement.

Perform further measurements

In addition to the QA value, the coverage of the measurements must also be checked. 100% coverage is required for a complete evaluation. Further measurements may have to be carried out for this purpose.



The eye needs to be held open wide enough for the desired measurement area not to be covered by the eyelids to achieve good coverage of the cornea and sclera. We recommend holding up the upper eyelid with the LidStick® or alternatively a long cotton swab. The patient can hold up his or her own lower eyelid with a finger. For a nasal scan, for example, it is important that the patient momentarily turns their head slightly, but looks at the red fixation mark.

- ➔ Click the [+] button to the right of the last measurement taken. The coverage area of each measurement is shown in a different color in the corresponding display. The coverage of all individual measurements is displayed summed up in the coverage map.
- ➔ Carry out further examinations until the area has been fully covered, i.e. a complete corneal scleral profile has been created.



- 1 Coverage by measurement 1
- 2 Additional coverage by measurement 2
- 3 Additional coverage by measurement 3
- 4 Coverage by single measurement 1
- 5 Coverage by single measurement 2
- 6 Coverage by single measurement 3
- 7 [Finish] button

Fig. 11-24: Coverages of individual measurements and total coverage

→ Click the [Finish] button to complete the CSP Pro measurement.

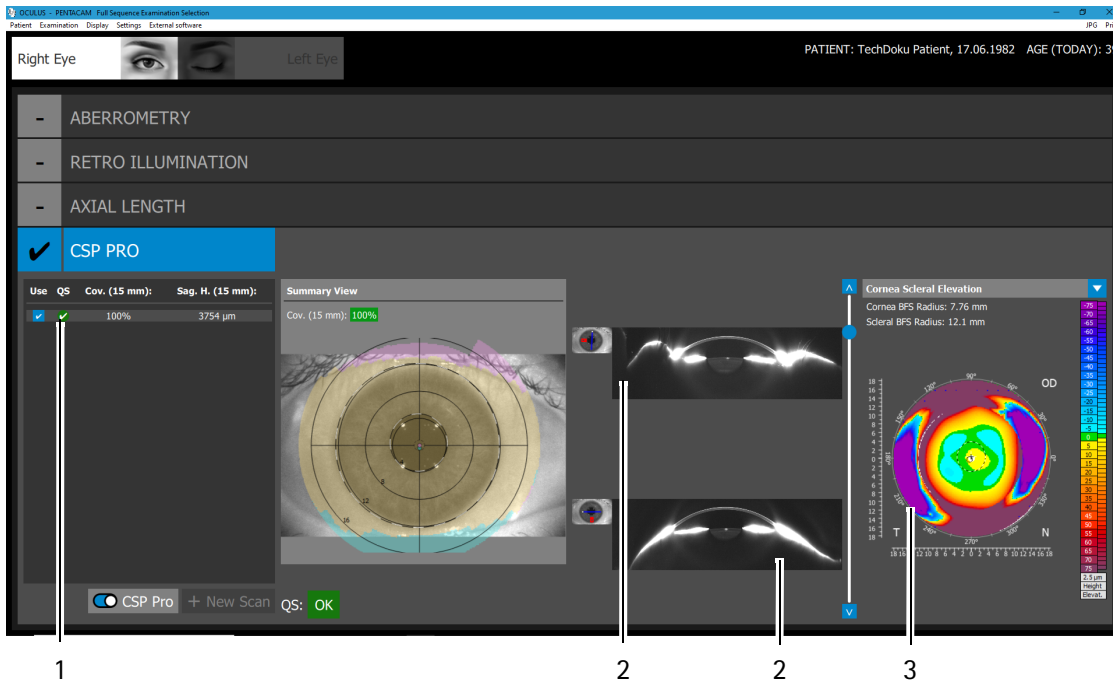

1 Parameters of the CSP Pro measurement

2 Scheimpflug images

3 Elevation map

Fig. 11-25: Completed CSP Pro measurement

CSP Pro measurement parameter (4)

- **Use:** Examination can be used for the evaluation.
Click the checkbox of the respective measurement to use it for the evaluation.
Use only one measurement for the full sequence examination.
- **QS:** Quality Specification value, see [sec. 11.6.1, page 55](#).
- **Cov.(15 mm):** Coverage of the cornea and sclera in percent.
- **Sag. H. (15 mm):** Sagittal height of the cornea for a diameter of 15 mm.

11.7 Perform a Single Scan for an Examination Mode

You can perform single scans for each examination mode, for example to check values after a surgery.

- Adjust the table height.
- Check that
 - fresh paper has been put onto the chin rest or the chin rest has been cleaned and disinfected, [sec. 14, page 77](#).
 - the forehead rest has been cleaned and disinfected after each examination, [sec. 14, page 77](#).
 - the lens in front of the camera and the acrylic glass are clean.
- Ask the patient to place his or her head on the chin and forehead rest.
- Do not touch the patient and the Pentacam® AXL Wave simultaneously.

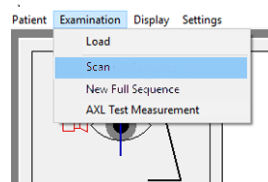
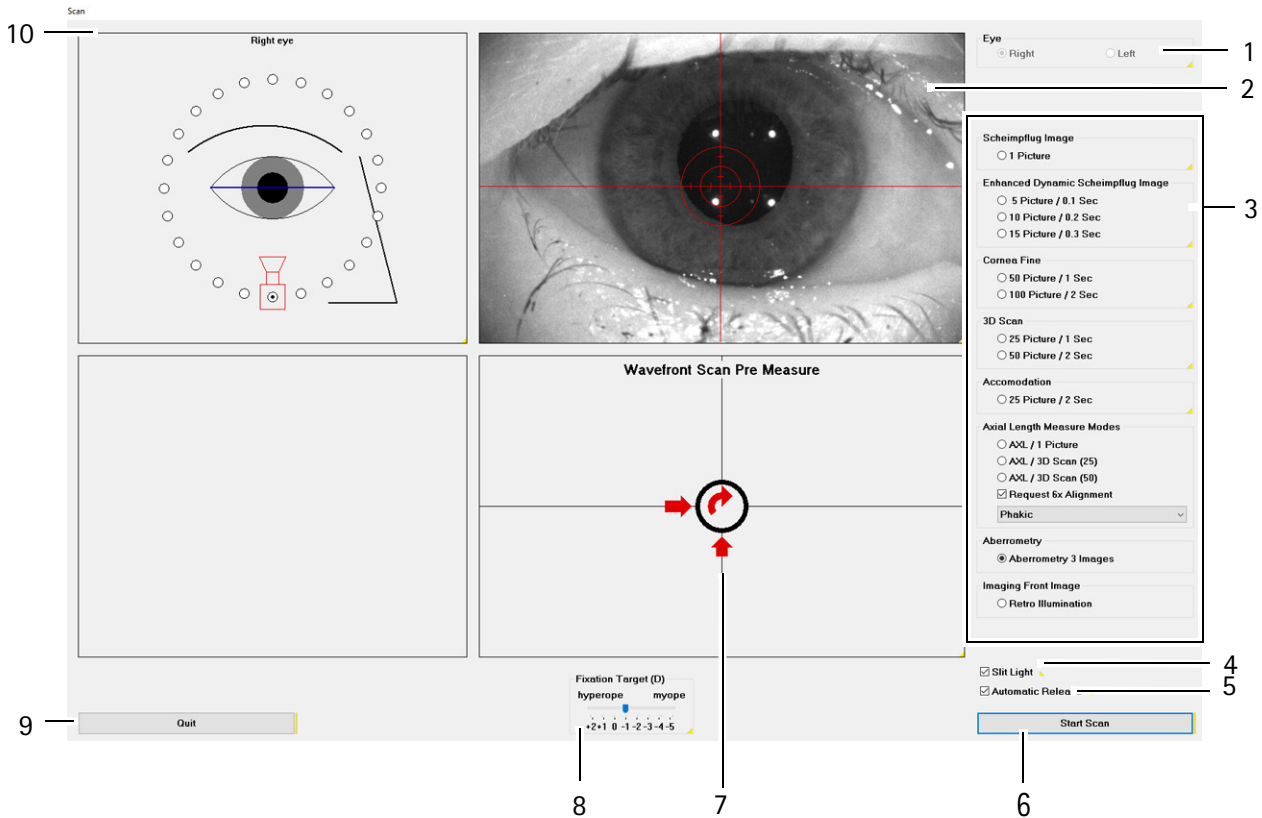

Fig. 11-26: Single scan start

- If the lighting in the examination room has not been turned down or switched off, use the dark sheet supplied to cover the patient and the Pentacam® AXL Wave.

➔ Select the [Examination] tab and click [Scan].



- 1 Display of currently examined eye
- 2 Overview image with adjusting aid
- 3 Examination mode area
- 4 [Slit Light] checkbox
- 5 [Automatic Release] checkbox

- 6 [Start Scan] button
- 7 Adjustment window
- 8 Fixation Target
- 9 [Quit] button
- 10 "Orientation" field

Fig. 11-27: Screen for single scans (example: aberrometry)

11.7.1 Procedure to take a single scan

- ➔ Select the examination mode (3), [sec. 11.7.3, page 61](#). Enable the depending radio buttons and checkboxes.
- ➔ Advise the patient to look at the fixation target/point. The eye currently being examined is detected automatically and is displayed in the display of currently examined eye (1).
- ➔ Adjust the camera, ["Rough adjustment" page 33](#), ["Fine adjustment" page 35](#). The Overview Image (2) shows the pupil and a cross hair as an adjusting aid.
- ➔ Shortly before you have reached the final position ask the patient to widen his or her eye and not to blink. The Pentacam® AXL Wave triggers the measurement automatically.

11.7.2 General settings

- Click the [Slit Light] checkbox (4) to activate/deactivate the blue light for illuminating the eye.
- Click the [Automatic Release] checkbox (5) to activate automatic measurement.
- Clicking the [Start Scan] button (6) activates manual measurement. You can also use the Return key.
- Inside the adjustment window (7), there are arrows showing you the direction in which you have to move the Pentacam® AXL Wave to activate automatic measurement (Automatic Release).
- The "Fixation Target" setting (8) is a parameter to optimize the fixation of the patient. For this, the active "Fixation Target" , for example the LED blinking red in the middle of the blue slit, can be shifted in steps of 0.5 D. The objective is to offset defects in the patient's vision and ensure a simpler method of fixation.
- Click the [Quit] button (9) to abort the measurement.
- The "Orientation" field (10) shows the respective position of the camera and the eye, which is currently being examined.

11.7.3 Scheimpflug image settings

You can set the number and type of images required for the respective examination in the "Image Options" box (3).

"Scheimpflug Image" group box

- If you activate this option, the camera records only one Scheimpflug image. You can freely select the camera position you require by clicking the white rings in the "Orientation" field (10).

"Enhanced Dynamic Scheimpflug Image" group box

- Use this option to make the camera record either 5, 10 or 15 Scheimpflug images, with the camera remaining in the same position. Image averaging is carried out on the recorded images to minimise background noise. Only one Scheimpflug image is displayed. You can freely select the camera position you require by clicking the white rings in the "Orientation" field (10). This type of image is suitable for a densitometric assessment of the lens.

"Cornea Fine" group box

- Select this option for a more detailed image of the cornea. The camera does not capture the deeper-lying layers. You can select 50 Scheimpflug images with a recording time of one second, or 100 Scheimpflug images with a recording time of two seconds.

"3D Scan" group box

- Use this option to select how many images you want the camera to record per scan. The difference is in the duration of the examination and the number of measuring points that are evaluated. A scan comprising of 50 images takes longer, but it provides the highest amount of measured elevation data.
- This type of examination is used for evaluating the cornea and anterior chamber.

"Accommodation" group box

- If you select this option, the camera will take a total of 50 Scheimpflug images. While the camera is recording the images, the "Fixation Target" shifts constantly from -5 D to +2 D. The camera records the Scheimpflug images from a pre-selected camera position.

"Axial Length Measure Modes" group box

- ➔ Select this option for measuring the axial length. If you select this option, the desired mode for the axial length measurement is enabled.
- ➔ Follow the instructions on the screen to align the patients eye to the Pentacam® AXL Wave. If the patients eye is aligned to the Pentacam® AXL Wave properly the Pentacam® AXL Wave measures six times the axial length of the patient's eye.
- ➔ Read the message on the screen and give the patient a break for blinking.
- ➔ Advise the patient to fixate on the red blinking light. Click on the OK button to proceed with the 3D scan.
- ➔ Follow the instructions on the screen to align the patient's eye to the Pentacam® AXL Wave properly.

If "Request 6x Alignment" is activated, the axial length measurement starts only if the patient is fixating correctly during the complete scan. After the Pentacam® AXL Wave is aligned properly, the measurement starts automatically.

"Request 6x Alignment" deactivated means: The axial length measurements are performed without any interruptions.

"Request 6x Alignment" is activated by default and should only be deactivated if the patient has problems to fixate on the red blinking light.

- ➔ Select the "Eye Status":
 - Phakic: Default status. Presence of crystalline lens.
 - Aphakic: Absence of the crystalline lens. Correction of measured axial length by +0.200 mm
 - Pseudophakic (Silicone IOL or similar): IOL of silicone or similar material implanted. Correction of axial length by +0.120 mm.
 - Pseudophakic (Acrylate): Acrylat/Metaacrylate IOL implanted. Correction of axial length by +0.110 mm.

Plausibility of axial length

During the measurement of both eyes the following messages may occur.

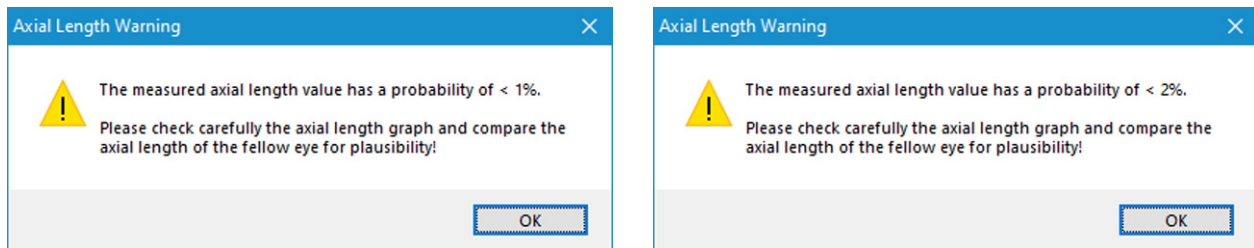

Fig. 11-28: Message: Plausibility check



Note

The axial length values do not correspond to the values of the normal population.

- ➔ Check the axial length values of both eyes.



The plausibility is marked by a yellow flagged QS value. This will be stored in the Pentacam® AXL Wave programme accordingly.

This symbol, related to the messages appears for example in the IOL calculator.

- ➔ Click on this symbol to show the corresponding message.

You must check the corresponding measured value.

If the measured axial length value has a probability of < 1%, the following message may occur.

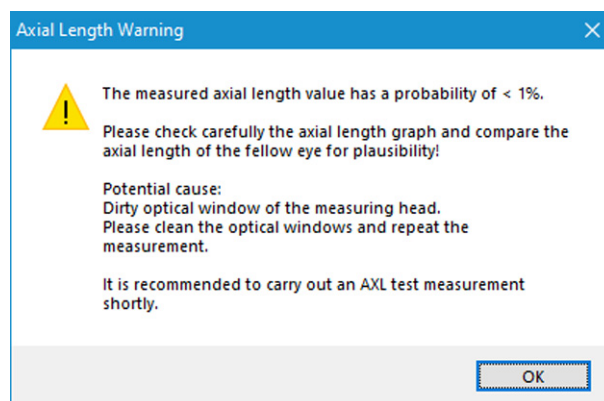

Fig. 11-29: Message: dirty optical window



Warning

Faulty measurements due to dirty window

- ➔ Clean the optical window.
- ➔ Carry out a test measurement.

If you do not carry out the test measurement, then this message will be stored in the Pentacam® AXL Wave programme accordingly marked by a red flagged QS value, for example in the IOL calculator.

- ➔ Repeat the measurement.

You must check the corresponding measured value.

"Aberrometry" group box

- Enables the wavefront aberrometry measurement.

"Imaging Front Image" group box

- Enables the retroillumination.

Further information on the capturing process see [sec. 10.4, page 31](#).

11.8 Manual measurement function in the Scheimpflug image

- ➔ Select the  button in the extended Scheimpflug image display .
- ➔ Click with the left mouse button on the Scheimpflug image and define the start point of the measurement.
- ➔ Now move the cursor and the distance between the start point and the current mouse position will be displayed in μm .
- ➔ To cancel the current measurement, press the right mouse button.
- ➔ Once you have reached the end point for the measurement, click the left mouse button again.

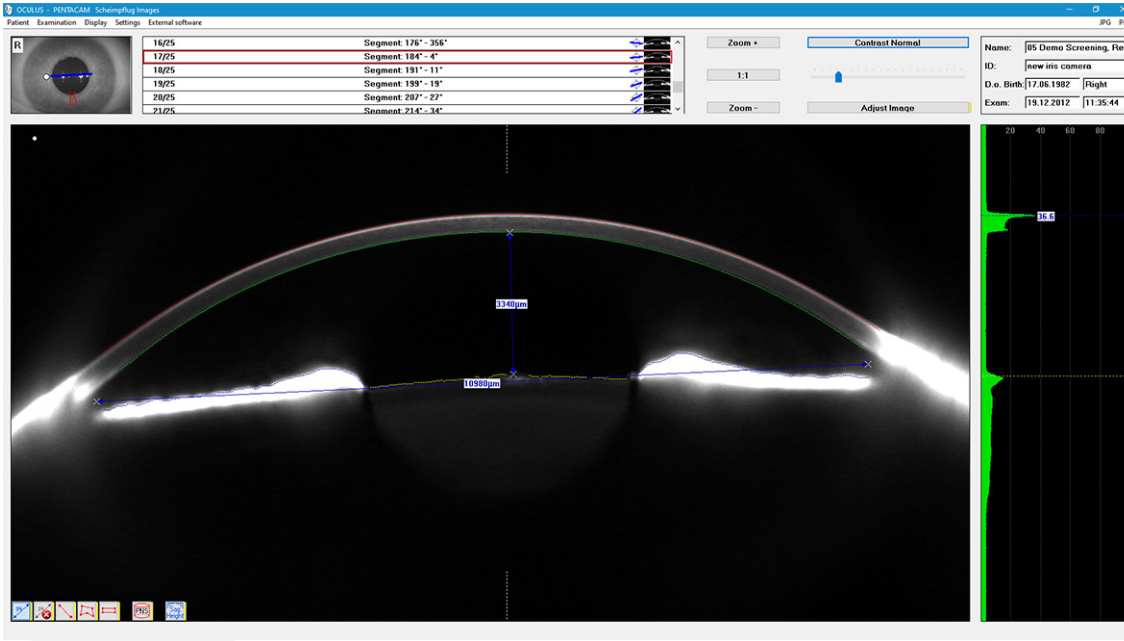

Fig. 11-30: Measurement function in the Scheimpflug image

The arrow head and the associate distance will now be permanently displayed.

- ➔ Click on the button . The last measuring line is deleted.

12 Managing Patient Data

Once you have completed an examination, you can do the following with the patient data:

- Rename it, [sec. 12.1, page 66](#)
- Export it, [sec. 12.2, page 66](#)
- Import it, [sec. 12.3, page 68](#)
- Back up, [sec. 12.4, page 69](#)



For more information on Patient Data Management, refer to the [User Guide](#).

12.1 Rename Patient Data

After creating of the patient data, you can edit it.

- ➔ Press the [Change] button.
The input boxes for patient data are now enabled, and the cursor jumps to the "Last name" field.
- ➔ Change the entries in the individual boxes.
- ➔ Press the [Save] button.

12.2 Exporting Patient Data

Patient and examination data can be exported, for example, for forwarding to another clinic.

- ➔ Select the patient and also one of the examinations in the respective list as required.
- ➔ Click [Export] button below the patient list. The following dialogue appears:

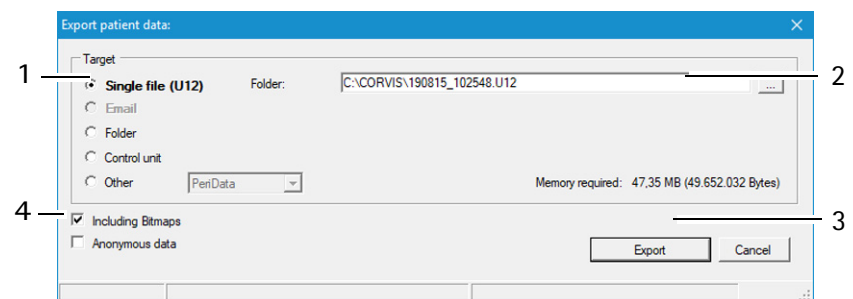

- | | |
|--------------------------------|---------------------------------|
| 1 Saving destination selection | 3 [Cancel] and [Export] buttons |
| 2 [...] button | 4 Options for data export |

Fig. 12-1: "Export patient data" dialog



The default options for import and export of data are configured in the "Settings" field, see also the [User Guide](#).

Depending on the settings, you may not have to perform all of the following steps (e.g. selection of the directory).

-
- Select the "Target" (1) where you would like to export the data.



Recommendation: Export the patient data using the "Single file (U12)" option.

-
- Press the [...] button. (2).
 - In the dialog that appears, select the folder or the file to which the patient data should be exported.
 - Specify the name and destination of the file you are saving.
 - Make sure you have selected [Including Bitmaps].
 - Click [Export].

The patient and examination data have now been saved at the destination specified.

You can send data stored on the hard drive as an e-mail attachment.



Note

Requirements for transferring data to another PC:

- The Pentacam® AXL Wave program must be installed on the other PC. If the program is updated on the Pentacam® AXL Wave PC (sender), the program on the other PC (recipient) must also be updated.
 - Make sure, that the PC is connected to a local network controlled by the Floating License Key or that a single license key is connected to the PC in order to interactively evaluate the exams.
-

12.3 Importing Patient Data

If you receive patient data, for example, on a USB stick, you can import these data.



Note

Risk of loss of data due to computer viruses

Computer viruses can cause loss of data.

➔ Run a virus check before importing data from the USB flash drive.

➔ Press the [Import] button. The following dialog appears:

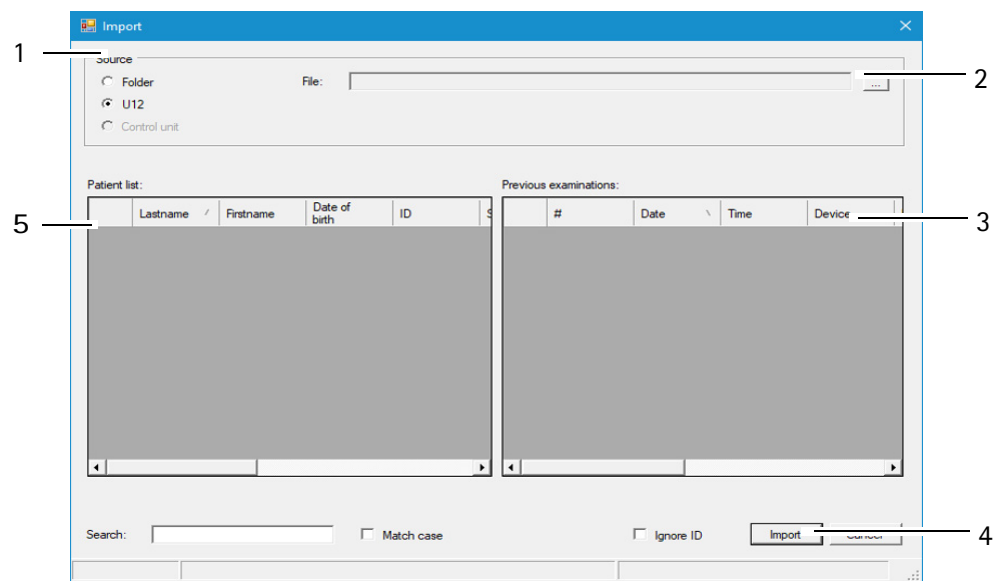

- 1 Select data source
- 2 [...] button
- 3 Previous examinations
- 4 [Import] button
- 5 Patient list

Fig. 12-2: "Import" dialog



The default options for import and export of data are configured in the "Settings" field, see also the [User Guide](#).

➔ Depending on the settings, you may not have to perform all of the following steps (e.g. selection of the directory).

➔ Select the option (1) where the source data are contained ("Folder" or "U12" (single file)).



Recommendation: Import the patient data using the "Single file (U12)" option.

- ➔ Press the [...] button. (2).
- ➔ In the dialog box, select the directory or the file where the patient data are located.
- ➔ Confirm your selection with [OK] or [Open].
The patients and the associated examinations that are found are displayed in the lower part of the dialog.
- ➔ To import the data, press the [Import] button (4).
The data will then be available in the Patient Data Management system.

12.4 Data Backup

You should make a backup copy of patient and examination data at regular intervals. In case of loss of data, you can reconstruct the data from a previously created backup with the help of this function. Since data backup takes several minutes, depending on the scope of the database and the data to be backed up, a backup should be carried out when the PC and the device will not be needed.



Note

Risk of loss of data due to computer viruses
Computer viruses can cause loss of data.

- ➔ Run a virus check before making a backup to a USB flash drive.



The general rules for security backups apply to the creation of backup copies created with the help of the Patient Data Management system. Storage of backup files should always be done on a separate system (e.g. on a USB flash drive with adequate capacity).

12.4.1 Backup Data

- ➔ Press the [Backup] button at the top right of the Patient Data Management system. The following dialog is displayed:

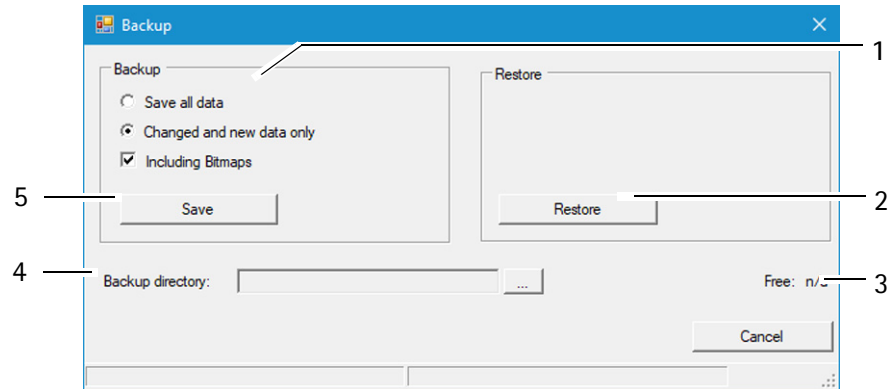

- | | |
|------------------------------|-------------------------------------|
| 1 Backup data selection | 4 Backup directory and button [...] |
| 2 [Restore] button | 5 [Save] button |
| 3 Display free storage space | |

Fig. 12-3: "Backup" dialog

- ➔ Select whether all of the data or only changed data should be backed up.



The Patient Data Management system internally tags all saved data records.

If you select the option "Changed and new data only", only the data records that were not saved during a previous backup will be backed up.

- ➔ Press the [...] button to the right of the "Backup directory" box (4).
- ➔ In the dialog that appears, select the folder to which the data should be backed up.
- ➔ Confirm your selection with [OK].
- ➔ To back up the data, press the [Save] button (5). The previously selected data will then be backed up to the corresponding folder.

12.4.2 Reconstructing Data

If a loss of data occurs, the data from a previous backup can be re-imported into the Patient Data Management system.

- ➔ Press the [...] button.
- ➔ In the dialog that appears, select the folder which contains the backup data.
- ➔ Confirm your selection with [OK].
- ➔ To import the data, press the [Restore] button (2). All data in the appropriate directory are copied to the Patient Data Management system.

12.4.3 Automatic Backup

In addition to the manually performed backup, it is also possible to automatically run a backup when exiting the Patient Data Management system. The settings required for this can be made in the "Settings" area, see [User Guide](#).

13 Test Measurements with the Pentacam® AXL Wave

The Pentacam® AXL Wave is tested and calibrated in the Oculus factory. OCULUS Optikgeraete GmbH recommends to perform regular test measurements of the Pentacam® AXL Wave.

You will be prompted by the software for test measurements.

13.1 Test Measurement: Axial length

13.1.1 Attach the test eye

Tool and material

- Pentacam® AXL Test eye (70108)
- 1.5 mm Allen key

Procedure

- ➔ Turn off the Pentacam® AXL Wave.
- ➔ Use the Allen key to attach the test eye to the chin and head rest, directly underneath the retainer for the head rest.

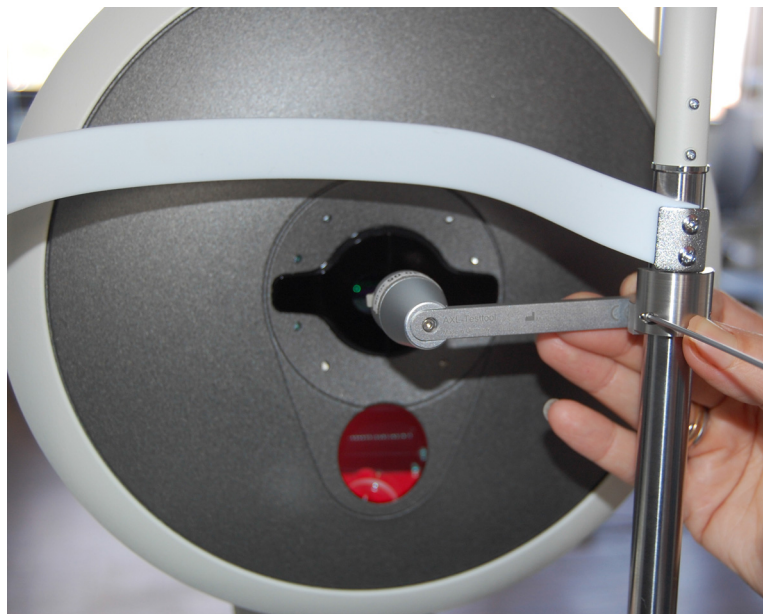

Fig. 13-1: Attach the test eye

- ➔ Make sure that the test eye is in park/home position when it is not being used.



Fig. 13-2: Test eye in park/home position

13.1.2 Perform the Axial length test measurement routine

The axial length test measurement routine has to be performed daily before the first "Full Sequence Examination". After the Full Sequence Mode is selected the following screen appears:

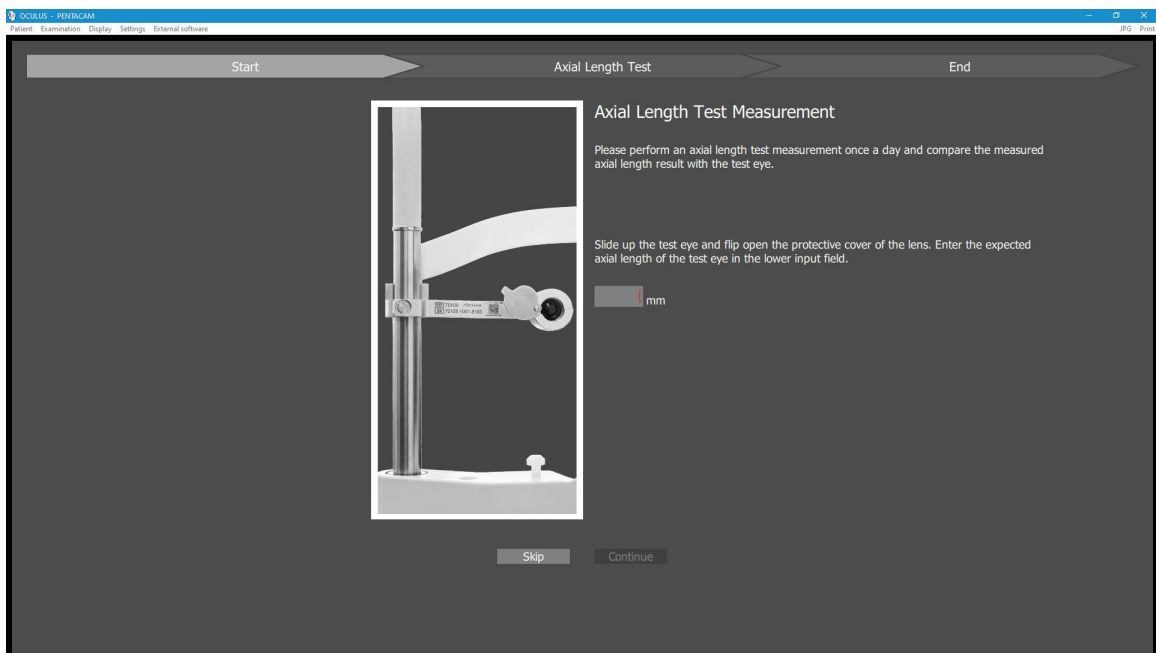

- ➔ Follow the instructions on the screen, type in the axial length of the test eye and click on "Continue"

For the case the test measurement is skipped it is saved in the software and all following AXL scans receive a bad QS value including the message "Missing test measurement"

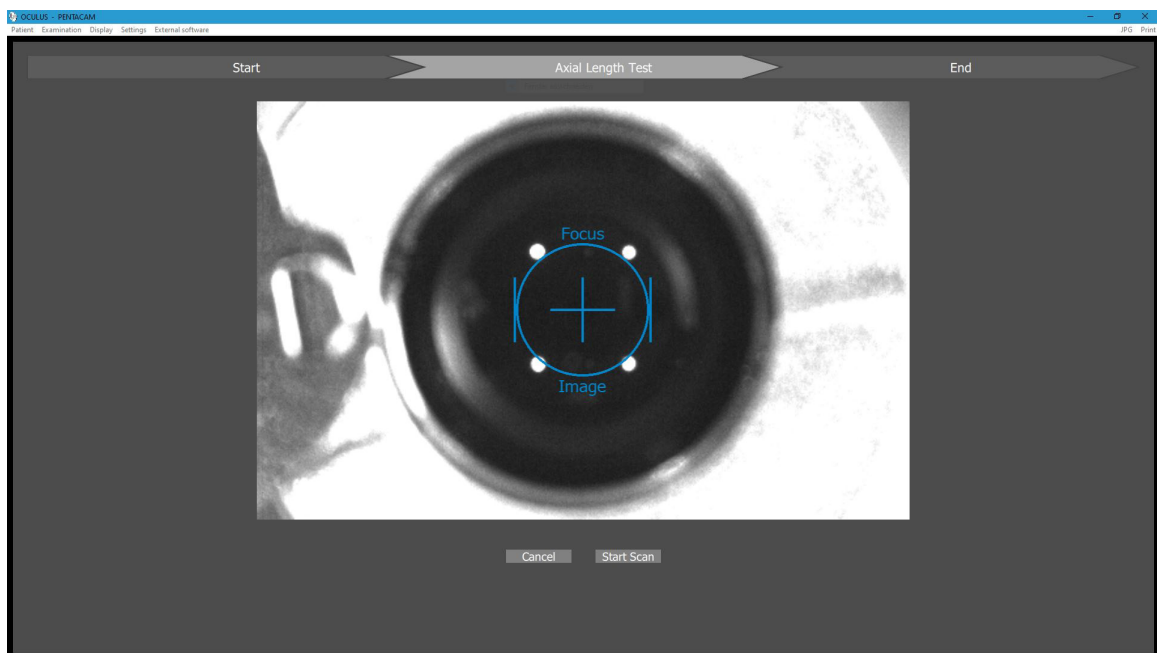

Align the Pentacam® AXL Wave to the test eye, "Fine adjustment" page 35.

➔ Press [Start Scan] or press the return button to start the test measurement manually.

In case the test measurement is ok the following message appears:

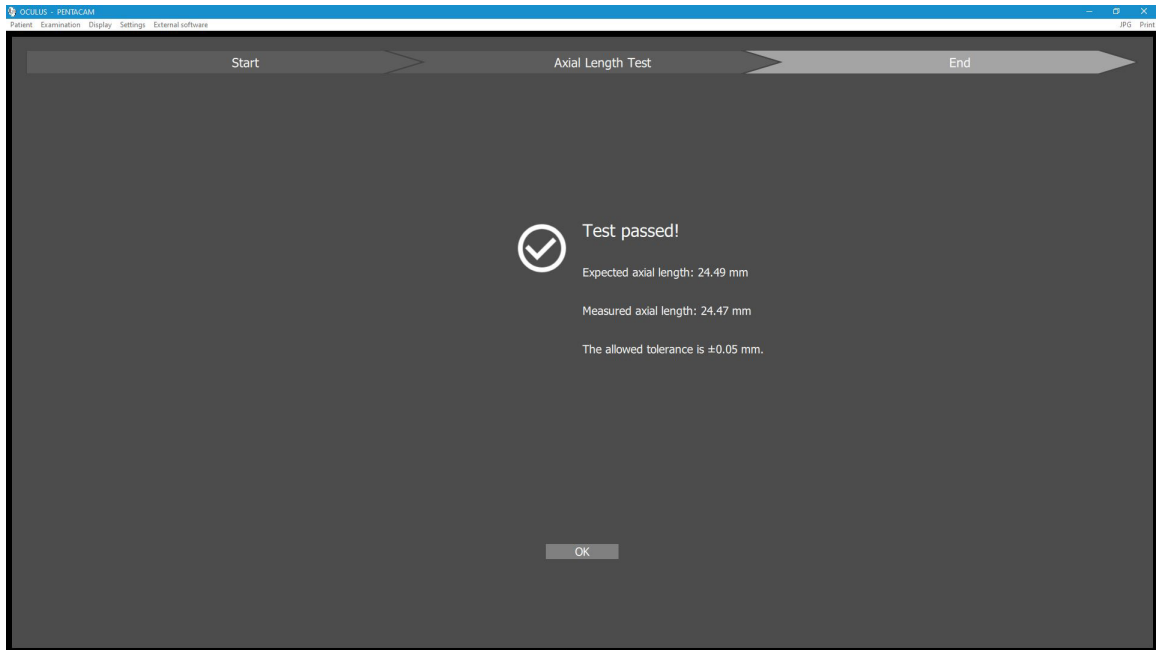

➔ To finish the process click "OK".

In case the test measurement failed the following message appears:

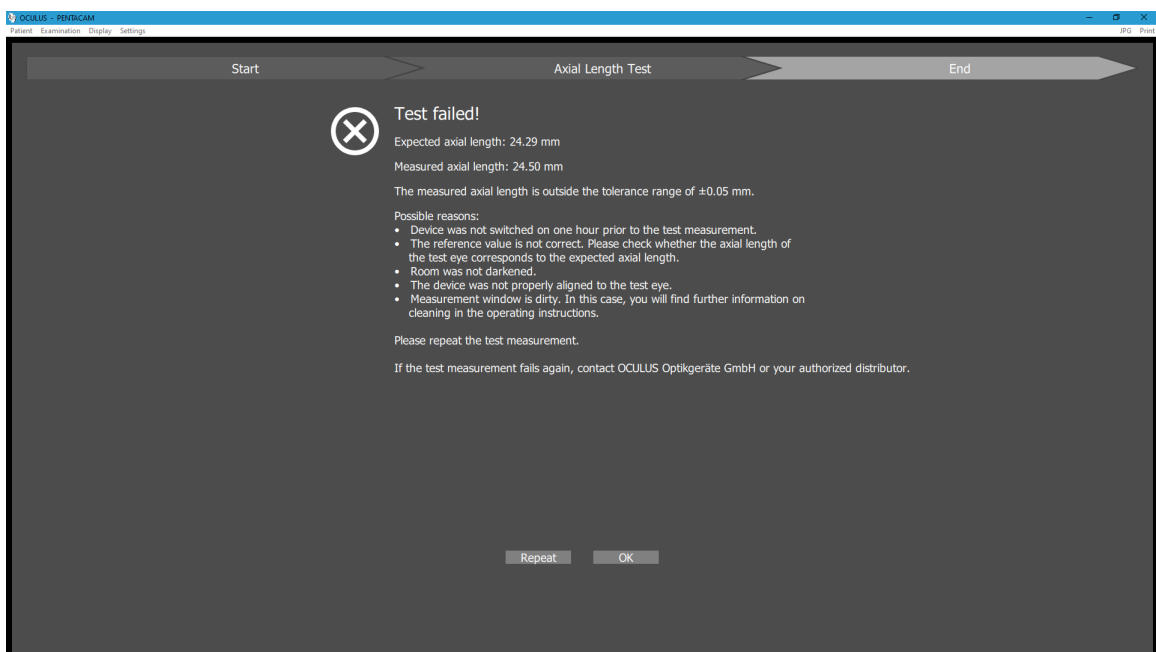

- ➔ Exclude all possible reasons (see screen) for a fail test measurement.
- ➔ Repeat the test measurement again.
- ➔ If also this test measurement is not successful please call your authorized dealer.
- ➔ To finish this process click "OK".



In case you had to replace the test eye because of any reason you have to type in the axial length of the new test eye into the input field before you do a new test measurement.

After the test measurement process is finished you can slide down the test eye..

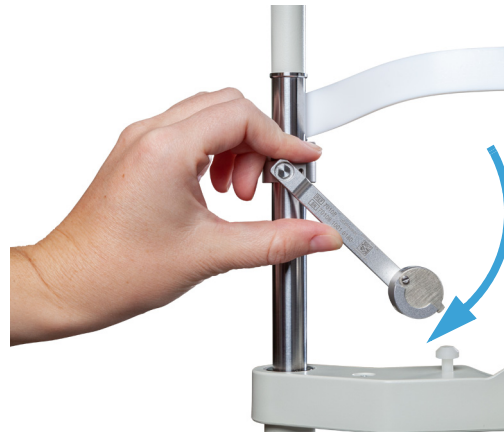

Fig. 13-3: Sliding down the test eye

The protective cover closes automatically. You can proceed with the measurements.



During an examination: If you adjust the chin rest for a smaller head (the head of a child, for example), the test eye may be in the way. Slide the test eye to the side and then adjust the chin rest.

13.2 Test Measurement: Tomography (3D scan)

The Pentacam® AXL Wave is tested and calibrated at OCULUS.

OCULUS Optikgeräte GmbH recommends to carry out additional regular test measurements with the Pentacam® AXL Wave.

Start the test with a measurement of a human eye. Carry out at least five successive measurements on each eye. Calculate the arithmetic mean and log the results.

Once a month, this measurement sequence should be carried out on the same eye as described above.

Compare the arithmetic mean from the initial measurement with the current measurement.

The following table depicts the tolerance range between the result of the initial measurement and the result of the current measurement:

	Tolerance range
Curvature	+/- 0,1 D
Pachymetry	+/- 10 µm

If the difference between the initial value and the current value lies outside the tolerance range, contact our service or your marketing authorisation holder. The values are shown in the overview display, for example; please refer to the [user manual](#).

14 Cleaning, Disinfection and Maintenance

Cleaning and disinfection of the Pentacam® AXL Wave is described in this chapter.

Sterilization is not required.

- ➔ Heed the product descriptions and instruction manuals of products and equipment you use to care for, clean, and disinfect the unit and/or its accessories.
- ➔ Do not clean the Pentacam® AXL Wave with aggressive, chlorine containing, abrasive or sharp cleaning agents.



Clean the cover glass from time to time to retain the high measurement accuracy of the Pentacam® AXL Wave and to avoid malfunctions. If the test measurement shows a peak at 39 mm, a corresponding message will occur, see [sec. 13, page 71](#).

14.1 Cleaning



Attention

Risk of electric shock if the Pentacam® AXL Wave is not completely disconnected from the mains for the cleaning.

- ➔ Turn the Pentacam® AXL Wave off, [sec. 7.3, page 21](#).
 - ➔ Pull the power plug before cleaning. When disconnecting electrical connections, pull on the respective plug and not on the cable itself.
-

Required materials:

- Antistatic cleaning agent
- Cleaner for painted surfaces: Mixture of equal parts of alcohol and distilled water, possibly with a few drops of household detergent
- Soft, lint-free cloth
- Purified compressed air
- commercial clean agent for the acrylic glass

Cleaning intervals

- ➔ Clean the components of the Pentacam® AXL Wave once a month or if necessary.

Cleaning the Housing

- ➔ It is best to clean the housing surfaces with a soft cloth and an anti-static cleaning agent.

- Wipe off any residue from painted surfaces with the mixture for painted surfaces.

Cleaning the Chin-Forehead Rest

- Make sure that no liquid gets into any of the openings of the Pentacam® AXL Wave.
Do not use liquid from aerosol cans.
- Clean the chin-forehead rest with a soap solution (or with alcohol, if very dirty).
- Use a lint-free, damp cloth.

Cleaning the illuminated slit

The optical components illuminating the slit, and the lens in front of the camera are precision parts and sensitive to pressure. The surfaces of these components are susceptible to scratching.



Note

When cleaning the illuminated slit, do not use a cloth or other cleaning agents.

- Carefully clean the centre of the illuminated slit with purified compressed air.
- Clean the lens in front of the camera using a dry, lint-free cloth.
- Clean the acrylic glass with a commercial clean agent.

14.2 Disinfection

- Recommendation: Use disinfection wipes suitable for medical devices, for example:
Mikrozid sensitive wipes premium; Fa. Schülke & Mayr
Softpack 48 Stück / Art. Nr. 165711
Schülke & Mayr GmbH; Tel: +4940521000 / Fax: +494052100318
E-Mail@schuelke.com; www.schuelke.com



Note

Equipment damage caused by disinfectant solution

The disinfectant solution may damage the surface of the device if it is sprayed directly on it.

- Spray the disinfectant solution onto a cleaning cloth, do not spray it directly on the device.

- Disinfect the forehead rest after each examination.

- ➔ If you do not use paper for the chinrest, disinfect the chinrest after each examination.

14.3 Maintenance

In order to retain the high measurement accuracy of the Pentacam® AXL Wave OCULUS Optikgeräte GmbH recommends to perform a maintenance service every two years or after 25000 scans. A corresponding message appears.

By daily pop up window:

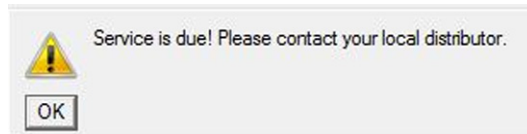

Fig. 14-1: Daily pop up window

In the settings, [see User Guide](#):



Fig. 14-2: Date of next service and number of performed examinations

In the scan menu, [sec. 10, page 30](#):



Fig. 14-3: Preliminary information (3 month before)



Fig. 14-4: Information when service is due

In examinations (it will be stored):



Fig. 14-5: Sign to perform maintenance

Let the Pentacam® AXL Wave checked by our service department or an authorized dealer.



Attention

Risk of personal injury or material damage due to invisible laser radiation
The Pentacam® AXL Wave contains a Class 1 laser according to IEC 60825-1: 2014. It is an encapsulated laser system. When the Pentacam® AXL Wave cover is opened, you may be exposed to invisible, Class 3R (5 mW) laser radiation.

- ➔ Never open the unit.
- ➔ For authorized service personnel only: When doing maintenance jobs, avoid looking directly into the laser beam.

14.4 Attaching Paper to the Chin Rest

If you want to attach new chin rest paper, follow these instructions:

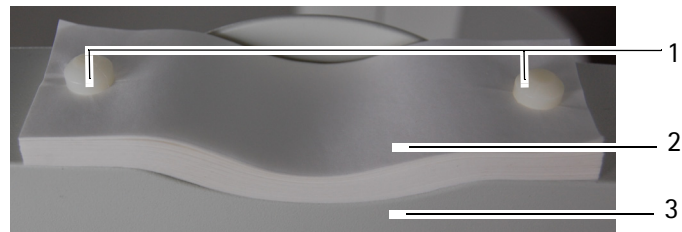

1 Pins

2 Paper for chin support

3 Chin rest

Fig. 14-6: Fasten chin rest paper

- ➔ Pull the two pins (1) out of the chin rest.
- ➔ Place the chin rest paper (2) in such a way that the holes of the paper and those in the chin rest (3) are aligned.
- ➔ Insert the two pins (1) in the chin rest.

15 Troubleshooting



Attention

If an error occurs which you are unable to correct by following the instructions below, label the device as "out of order" and contact our service department or an authorised dealer.

Error	Possible cause	Remedy
After you have started the Pentacam® AXL Wave program (sec. 9, page 26), the following dialog box appears: "No communication with Pentacam!".	No power to the power adapter.	Check whether the indicator light on the power supply is on. If not, connect the power supply to the mains.
	Connection cable of the Pentacam® AXL Wave is not plugged properly.	Check whether <ul style="list-style-type: none"> ■ the power supply cable is correctly attached to the Pentacam® AXL Wave. ■ the blue slit light is visible in the Scan menu (sec. 10, page 30). ■ the USB connector is properly inserted.
	Software/hardware problems	Switch the Pentacam® AXL Wave off and restart the PC. Switch the Pentacam® AXL Wave on as soon as Patient Data Management becomes active. When you start the Pentacam® AXL Wave program, the message, "Load Bootloader" must appear. Contact the service department or your authorised dealer.

16 Transport and Storage

The Pentacam® AXL Wave, must be properly dismantled and packed before being transported or stored.

16.1 Information on Transport and Storage

Storage

Ambient temperature range	-10 – +55°C
Relative humidity, including condensation	10 – 95%
Air pressure range	700 – 1060 hPa

Transport

Ambient temperature range	-40 – +70°C
Relative humidity, including condensation	10 – 95%
Air pressure range	500 – 1060 hPa

16.2 Disassembly

- End the current session.
- Switch off the device.
- Disconnect the cable from the computer/laptop and the power adapter.



Fig. 16-1: Disassembly

- Loosen the screw connection of the Y cable and pull it out. Only pull on the plugs, not on the cables itself.

16.3 Transport and Storage



Attention

Risk of equipment damage due to incorrect shipment or from improper storage

- Avoid shocks, vibrations, and contamination.
 - Avoid high temperatures and humidity.
-
- Transport the Pentacam® AXL Wave carefully.
 - Do not hold the device by the joystick to carry it.
 - Store the Pentacam® AXL Wave in compliance with the storage conditions.
 - Avoid placing near heaters and moisture.

17 Disposal



In accordance with Directive 2012/19/EC of the European Parliament and the Council of 4th of July 2012, and in accordance with German law governing the marketing, return and environmentally compatible disposal of used electrical and electronic devices, such appliances must be recycled and may not be discarded as household waste.

→ Dispose the Pentacam® AXL Wave in a compliant manner.

18 Terms of Warranty and Servicing

18.1 Terms of Warranty

Please note the following warranty provisions:

- Prior to and while operating the device it is important that you heed the instruction manual and safety instructions.
- In accordance with legal regulations, you are entitled to a warranty for the Pentacam® AXL Wave.
- If modifications are made to the Pentacam® AXL Wave by unauthorized persons, all warranty claims shall be voided. Improper modifications and repairs may result in considerable hazards to users and patients.
- Any entitlement to a warranty shall also be void if unauthorized persons interfere with the supplied computer hardware and software.
- Any transport damage must be reported immediately to the shipping company. Have the transport damage noted on the bill of lading so that complaint handling and compensation of damages can proceed in an orderly manner.
- In general, our Business and Shipping Terms on the date of purchase apply.

18.2 Assumption of Liability for Functions and Damage

OCULUS will only accept responsibility for the safety, reliability and serviceability of the Pentacam® AXL Wave if the unit is used in compliance with the following terms:

- Only use the equipment in conformance with this instruction manual.
- There are no parts either on or inside the Pentacam® AXL Wave that require maintenance or repair by the user. If assembly work, modifications, adjustments, repairs, changes or service are performed by unauthorized personnel, or if the Pentacam® AXL Wave is improperly maintained or handled, then any liability by OCULUS is voided.
- If the above-referenced work is performed by authorized persons, request a certification of the scope and type of repair, and, if necessary, the changes to the standard values or to the operating range from the service technician. This certification must contain the date of performance and statement of the performing firm, with signature.
- If requested, OCULUS will provide the service technician with a list of spare parts and additional descriptive material for this purpose.
- Make certain that only original OCULUS parts are used.

18.3 Manufacturer and Service Address

Supplemental information is available from our Service Department or from our authorized representatives.

Manufacturer and Service address:

OCULUS Optikgeräte GmbH
 Münchholzhäuser Straße 29
 35582 Wetzlar
 GERMANY
 Tel.: +49 641 2005-0
 Fax: +49 641 2005-295
 E-mail: export@oculus.de
www.oculus.de



USA:

OCULUS, Inc.
 17721 59th Avenue NE
 Arlington
 WA 98223
 Tel. +1 425 670 9977
 Fax +1 425 670 0742
 E-mail: sales@oculususa.com
www.oculususa.com



19 Technical Data

Measuring equipment

Camera	Digital CMOS camera
Light source	Blue LED (475 nm, UV-free)
Processor	DSP with 2746 Mio. floating point operations per second
Speed	100 images in 2 seconds (Cornea Fine Scan)
Dimensions W x D x H (measuring head)	278 x 320 to 400 x 502 to 532 mm (10.9 x 12.6 to 15.7 x 19.8 to 21.0 in)
Weight Pentacam® AXL Wave (measuring head)	9.0 kg (20.2 lbs)

Measuring range

Corneal topographer according ISO 19980	Type A
Curvature	3 to 38 mm 9 to 99 D
Accuracy	± 0.1 D
Reproducibility	± 0.1 D
Working distance	80 mm
Axial length Reproducibility	14 to 40 mm ± 30µm
Refraction	-10 D to + 6 D (7 mm pupil)

Power adapter

Power adapter	HEMG 49 (05150150)
Mains connection	90 - 264 V AC
Frequency	47 - 63 Hz
Power input, max.	85 VA
Output voltage	24 V DC
Fuses	Integrated overcurrent shut-off

Power supply Pentacam® AXL Wave

Output voltage	24 V DC
Max. power consumption	35 W

Other information

Contraindications	none known
Lifecycle expectancy	Up to 10 years

Classification according to IEC 60601 - 1

Type of protection against electrical shock	Protection class 2
Level of protection against electrical shock	Type B
Level of protection against damaging water entry	IP20

Ambient operating requirements

Temperature	+10 – +35 °C
Humidity	30 – 90%
Air pressure	800 – 1060 hPa

Storage conditions

Ambient temperature range	-10 – +55°C
Relative humidity, including condensation	10 – 95%
Air pressure range	700 – 1060 hPa

Transport conditions

Ambient temperature range	-40 – +70°C
Relative humidity, including condensation	10 – 95%
Air pressure range	500 – 1060 hPa

Computer

Use a computer which is in conformity with the IEC 60950 or IEC 62368-1 standard.

Recommended computer specifications	Intel® Core™ i5, 500 GB HDD, 8 GB RAM, Windows® 10, Intel® HD Graphics
-------------------------------------	--

CE in accordance with Regulation (EU) 2017/745 on Medical Devices

The unit is a Class IIa product.



Conformity assessment procedure: (EU) 2017/745 MDR, Annex IX, Chapters I and III

Classification according to IEC 60825-1: 2001 and IEC 60825-1: 2014

The unit contains a class 1 laser classified SLED	
Maximum output of the laser radiation	0.7 mW
Single pulse duration	520 ms
Pulse count per examination	6x
Wavelength	880 nm

ISO 15004-2:2007 Group 2 instrument

A graph showing the relative spectral output of the instrument between 305 nm and 1100 nm when the instrument is operating at maximum light intensity and maximum aperture will be provided by OCULUS on request. The spectral output will be shown for the beam after it exits the instrument.



Caution

The light emitted from this instrument is potentially hazardous. The longer the duration of exposure and the greater the number of pulses, the greater the risk of ocular damage. Exposure to light from this instrument when operated at maximum output will exceed the safety guideline after 48 treatments.

20 Annex

20.1 Electromagnetic Compatibility

Medical electrical equipment is subject to special preAttentionary requirements with respect to EMC, and must be installed and operated according to the EMC-Instructions contained in the accompanying paperwork.

No special measures need be observed in respect of OCULUS devices and systems.

Portable and mobile RF-communications devices can interfere with electrically operated medical devices.

Manufactured under consideration of permitted degradations during or as a consequence of the EMC test without affecting the basic safety:

- A short interruption of the USB connection during the examination is permissible because it will not affect the diagnosis, treatment and observation.



Attention

The use of accessories, transducers and cables not specified by OCULUS (for example as replacement parts) may result in increased emissions or decreased immunity of the Pentacam® AXL Wave.

- ➔ Use only the original accessories, transducers and cables specified by OCULUS.

The use of accessories, transducers and cables specified by OCULUS with devices other than the Pentacam® AXL Wave may result in increased emissions or decreased immunity of the other device.

- ➔ Do not use the accessories, transducers and cables specified by OCULUS with devices other than the Pentacam® AXL Wave.
-

To be in compliance with the requirements of the IEC 60601-1-2. 6.1 and 6.2 the following types of equipment, accessories, power adapters and cables must be used.

Order number	Description	
70020	Pentacam [®] AXL Wave	
05200320	Cable with connector plug, EU standard	2.5 m (98.4 in)
05200210 (110 Volt)	Cable with connector plug, US standard	2.5 m (98.4 in)
05150150	Power adapter HMEG 49	24 V, 2,1A
70002	Y cable with galvanic isolation	2 m

20.2 Guidance and Manufacturer's Declaration - Electromagnetic Emissions and Immunity for the Pentacam® AXL Wave

Guidance and manufacturer's declaration electromagnetic emissions
IEC 60601-1-2: 2015, based to table 1

The OCULUS Pentacam® AXL Wave is intended for operation in the electromagnetic environment specified below. The user of the Pentacam® AXL Wave should ensure that it is being used in such an environment.

Emissions test	Compliance	Electromagnetic environment – guidance
RF emissions CISPR 11	Group 1	The Pentacam® AXL Wave uses RF energy only for its internal function. Therefore, its RF emissions are very low and are not likely to cause any interference in nearby electronic equipment.
HF-emissions CISPR 11	Class B	
Harmonics emissions IEC 61000-3-2	Class A	
Voltage fluctuations / flicker emissions IEC 61000-3-3	complies	

Electromagnetic immunity, IEC 60601-1-2: 2015, based on table 4			
Immunity test	IEC 60601 test level	Compliance level	Electromagnetic environment – guidance
Electrostatic discharge (ESD) IEC 61000-4-2	± 8 kV contact ± 15 kV air	± 8 kV ± 15 kV	Floors should be made of wood or concrete or covered with ceramic tiles. If the floor is covered with synthetic material, the relative humidity must be at least 30%.
Power frequency (50/60Hz) magnetic field IEC 61000-4-8	30 A/m 50 Hz or 60 Hz	30 A/m 50 Hz or 60 Hz	Power frequency magnetic fields should be at levels characteristic of a typical location in a typical commercial or hospital environment.
Electromagnetic immunity, IEC 60601-1-2: 2015, based on table 5, 8			
Electrical Fast transient/bursts IEC 61000-4-4	± 2 kV for power supply lines 100 kHz repetition frequency ± 1 kV for input/output lines	± 2 kV ----- ± 1 kV	Mains power quality should be that of a typical commercial or hospital environment.
Surge IEC 61000-4-5	± 1 kV line(s) to line(s) ± 2 kV line(s) to earth	± 1 kV differential mode ± 2 kV line(s) to earth	Mains power quality should be that of a typical commercial or hospital environment.
Voltage dips, short interruptions, and voltage variations on power supply input lines IEC 61000-4-11	0% U_T ; 1/2 period at 0, 45, 90, 135, 180, 225, 270 and 315 degree 0% U_T ; 1 period and 70% U_T ; 25/30 periods Single-phase: at 0 degree 0% U_T ; 250/300 periods	0% U_T ; 1/2 period at 0, 45, 90, 135, 180, 225, 270 and 315 degree 0% U_T ; 1 period and 70% U_T ; 25/30 periods Single-phase: at 0 degree 0% U_T ; 250/300 periods	Mains power quality should be that of a typical commercial or hospital environment. If the user of the Pentacam® AXL Wave requires continued operation during power mains interruptions, it is recommended that the Pentacam® AXL Wave be powered from an uninterruptible power supply or battery.
Note: U_T is the a.c. mains voltage prior to application of the test level.			

Electromagnetic immunity, IEC 60601-1-2: 2015, based on table 4, 5

Immunity test	IEC 60601 test level	Compliance level	Electromagnetic environment – Guidelines
Conducted RF IEC 61000-4-6	3 V _{eff} 150 KHz to 80 Mhz 6 V in ISM- and amateur radio frequency bands between 150 kHz and 80 MHz 80% AM to 1 kHz	V _{eff} = 3 V	Portable and mobile RF communications equipment should be used no closer to any part of Pentacam® AXL Wave, including cables, than the recommended separation distance calculated from the equation applicable to the frequency of the transmitter. Recommended separation distance $d = \left[\frac{3,5}{(V_1)} \right] \sqrt{P}$ $d = \left[\frac{3,5}{(E_1)} \right] \sqrt{P} \quad 80\text{MHz to } 800 \text{ MHz}$
Radiated RF IEC 61000-4-3	3 V/m 80 MHz to 2,7 GHz 80% AM at 1 kHz		$d = \left[\frac{7}{(E_1)} \right] \sqrt{P} \quad 800 \text{ MHz to } 2.5 \text{ GHz}$ <p>where P is the maximum output power rating of the transmitter in watts (W) according to the transmitter manufacturer and d is the recommended separation distance in metres (m).</p> <p>Field strength from fixed RF transmitters, as determined by an electromagnetic site survey (a), should be less than the compliance level in each frequency range (b).</p> <p>Interference may occur in the vicinity of equipment marked with the following symbol:</p> 

Note 1: At 80 Hz and 800 MHz, the higher frequency range applies.
 Note 2: These guidelines may not apply in all situations. Electromagnetic propagation is affected by absorption and reflection from structures, objects and people.

- a. Field strengths from fixed transmitters, such as base stations for radio (cellular/cordless) telephones and land mobile radios, amateur radios, AM and FM radio broadcast, and TV broadcast cannot be predicted theoretically with accuracy. To assess the electromagnetic environment due to fixed RF transmitters, and electromagnetic site survey should be considered. If the measured field strength in the location in which the Pentacam® AXL Wave is used exceeds the applicable RF compliance level above, the Pentacam® AXL Wave should be observed to verify normal operation. If abnormal performance is observed, additional measures may be necessary, such as re-orienting or relocating the Pentacam® AXL Wave.
- b. Over the frequency range 150 KHz to 80 MHz, field strengths should be less than 3 V/m.

Recommended separation distances between portable and mobile RF communications equipment and the Pentacam® AXL Wave, IEC 60601-1-2:2007, table 6

The Pentacam® AXL Wave is intended for use in an electromagnetic environment in which radiated RF disturbances are controlled. The customer or the user of the Pentacam® AXL Wave can help prevent electromagnetic interference by maintaining a minimum distance between portable and mobile RF communications equipment (transmitters) and the Pentacam® AXL Wave as recommended below, according to the maximum output power of the communications equipment.

Rated maximum output power of transmitter W	Separation distance according to frequency of transmitter m		
	150 KHz to 80 Mhz $d= 1.2 \sqrt{P}$	80 MHz to 800 MHz $d= 1.2 \sqrt{P}$	800 MHz to 2.5 GHz $d= 2.3 \sqrt{P}$
0.01	0.12	0.12	0.23
0.1	0.38	0.38	0.73
1	1.2	1.2	2.3
10	3.80	3.80	7.3
100	12	12	23

For transmitters rated at a maximum output power not listed above, the recommended separation distance d in metres (m) can be estimated using the equation applicable to the frequency of the transmitter, where P is the maximum output power rating of the transmitter in watts (W) according to the transmitter manufacturer.

NOTE 1: At 80 MHz and 800 MHz, the separation distance for the higher frequency range applies.

NOTE 2: These guidelines may not apply in all situations. Electromagnetic propagation is affected by absorption and reflection from structures, objects and people.

20.3 Description of the Connection

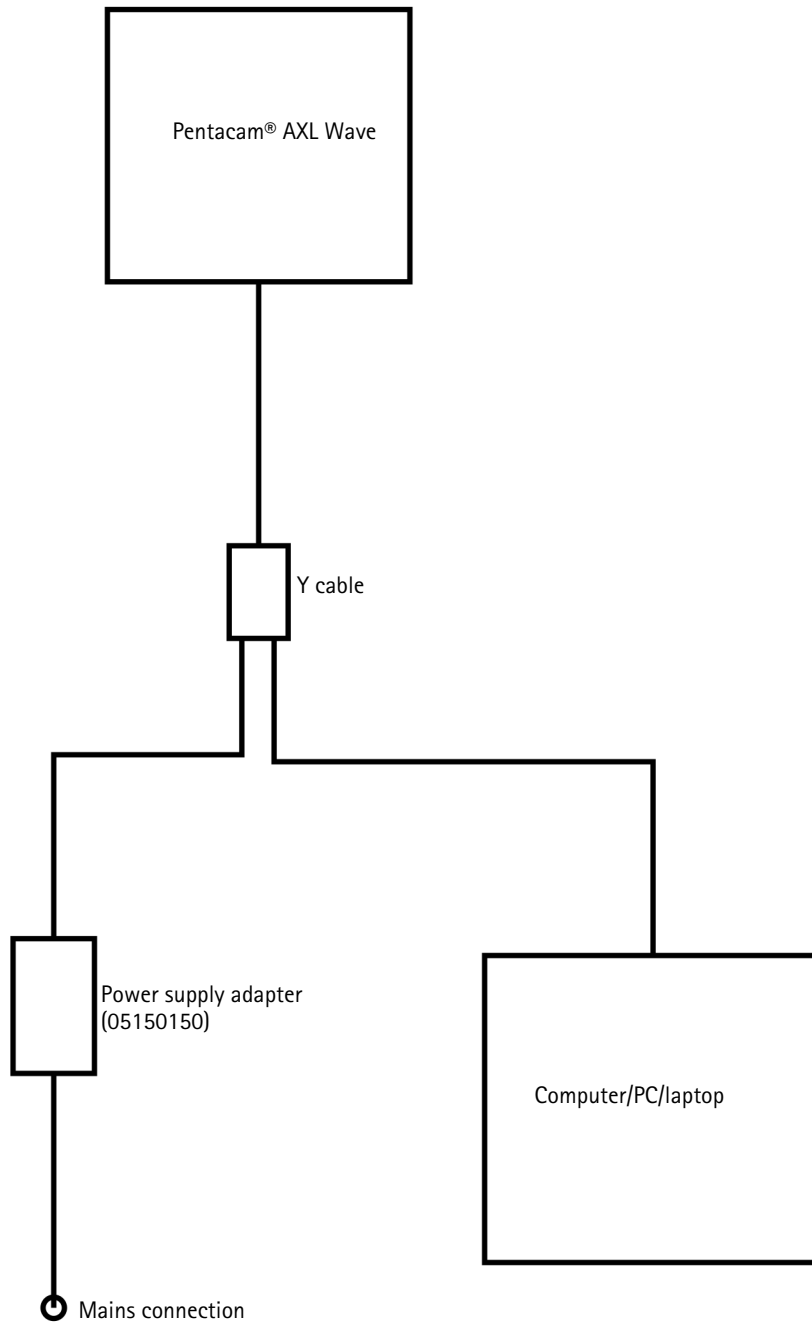

20.4 Data Sheet HEMG 49-S240210-7 [05150150]

HiTRON

UNIVERSAL INPUT AC-DC MEDICAL & ITE APPLICATION EXTERNAL DESKTOP SWITCHING ADAPTER 48-50 WATTS GREEN POWER SINGLE OUTPUT HEMG49 SERIES



FEATURES:

- ACCOMMODATE UNIVERSAL AC INPUT
- MEET MEDICAL STANDARDS IEC60601-1 & ITE STANDARDS IEC60950-1
- EMI MEET EN 55011 & EN55022 / FCC CLASS B
- MEET ENERGY STAR LEVEL V & CEC LEVEL IV
- CE MARKING COMPLIANCE

SPECIFICATION

INPUT SPECIFICATION

Input Voltage: Typical 90-264Vac.
Input Connector: 3 pole AC inlet IEC320-C14(DT7) / 2 pole AC inlet IEC320-C8(DT8).
Input Frequency: 47-63Hz.
Inrush Current: 12Arms (52Apk) at 230Vac.
Input Current: Typical 0.91A at 115Vac/ 0.57A at 230Vac.
Dielectric Withstand: Meet IEC60601-1 & IEC60950-1.
EMI: Meet EN55011 & EN55022 / FCC Class B.
Hold-up Time: Typical 12mS at 115Vac. Typical 70mS at 230Vac.
Over Temp. Protection: Optional (NTC circuit).
Earth Leakage Current (Class I) : Less than 0.3 mA.
Touch Leakage Current (Class I & II) :Less than 0.1mA.
No Load Power: Less than 0.3W at 230Vac

OUTPUT SPECIFICATION

Output Voltage: See Ratings Chart.
Output Current: See Ratings Chart.
Output Wattage: Typical 48-50Watts.
Output Connector & Cord: Optional.
Line Regulation: Typical 0.1%.
Load Regulation: Typical $\pm 1.5-3.0\%$.
Noise & Ripple: 1.0% peak to peak.
OVP: Built-in by latch circuit.
Adjustability: Factory set.
Over Current Protection (OCP):
 Fully protected against output overload and short circuit.
 The PSU will shut down after OCP is activated.
 Consult the factory for OCP setting.

GENERAL SPECIFICATION

Efficiency: Typical 87%-88% (various with the output voltage)
Switching Frequency: Typical 65KHz.
Circuit Topology: Fixed Frequency Flyback circuit.
Transient Response: Output voltage returns in less than 5.5mS following a 50% load change.
Safety Standard: Meet Medical IEC60601-1 & ITE IEC60950-1, Class I for DT7(C14) or Class II for DT8(C8)

Operating Temperature: 0°C to +40°C.
Storage Temperature: -20 to +85°C.
Cooling: Free air convection.
Construction: Impact resistant thermo-plastic enclosure case.
Power Density: 3.14-3.27Watts. / Cubic inch.
Desktop Format.

NOTE: (1) All measurements are at nominal input, full load, and +25°C unless otherwise specified.
 (2) Load regulation is measured at 115Vac or 230Vac in percentage to indicate the change in output voltage as the load varied from half load to full load ($\pm\%$).
 (3) The exact obtainable load regulation depends upon the output cord selected and load current.
 (4) Due to requests in market and advances in technology, specifications subject to change without notice.



For the details of safety approval, please consult the factory.

OUTPUT VOLTAGE / CURRENT RATINGS CHART

SINGLE OUTPUT

MODEL NO.	AC INLET	O/P VOLTAGE	O/P CURRENT
HEMG49-S120400-7	IEC320-C14(DT7)	12.0Vdc	4.0A
HEMG49-S120400-8	IEC320-C8(DT8)	12.0Vdc	4.0A
HEMG49-S150330-7	IEC320-C14(DT7)	15.0Vdc	3.3A
HEMG49-S150330-8	IEC320-C8(DT8)	15.0Vdc	3.3A
HEMG49-S240210-7	IEC320-C14(DT7)	24.0Vdc	2.1A
HEMG49-S240210-8	IEC320-C8(DT8)	24.0Vdc	2.1A

MECHANICAL DIMENSIONS: MM [INCHES]

WEIGHT: 373.0g (13.2 Oz.)

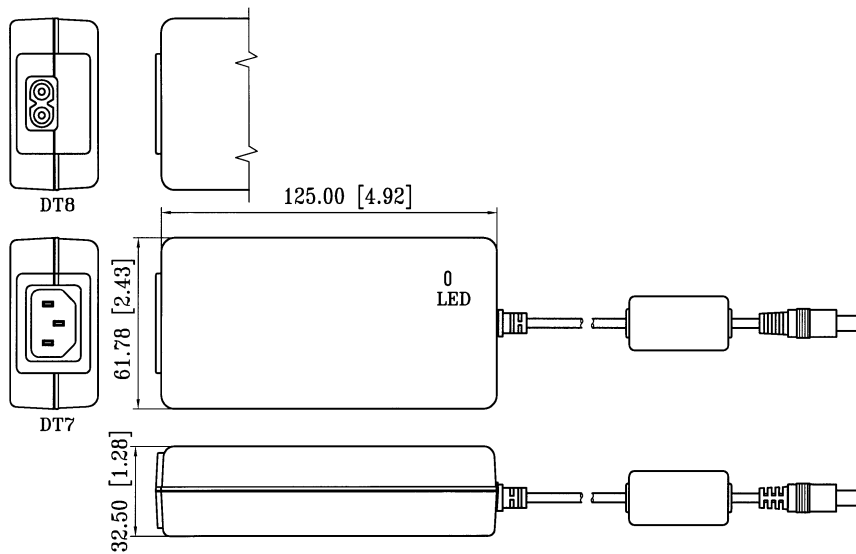

20.5 Instructions for integration into an IT-Network

The device, in conjunction with the connected computer and the device software running on it, forms a programmable electrical medical system (PEMS) according to IEC 60601-1.

It is essential that you follow the section "Cybersecurity Instructions" page 12 of "Safety Instructions" page 6 in the device instruction manual. Please note the following information for implementing an integration of the PEMS into an IT-Network:

The purpose of integrating the PEMS into an IT-Network can be:

- Licensing by local license server
- Storage and retrieval of the examination data on a local network drive
- Printing
- Data export
- DICOM workflow

Required characteristics of the IT-Network into which the PEMS is to be integrated:

- Prefer wired LAN connection
- IPv4 network
- Fast-Ethernet (100 Mbit/s minimum)

Required configuration of the IT-Network into which the PEMS is to be integrated:

- Licensing: required opened ports: 3968 TCP; 51371 - 51372 UDP
- Storage, printing, data export: File and Printer Sharing for Microsoft Networks (SMB 3.0 or higher - required opened port: 445]
- DICOM Storage Service Class = PACS
- DICOM Worklist Management Service Class (Modality Worklist Server)

Technical specifications of the network connection with the PEMS, including the specifications of data security:

- Refer to the section "Cybersecurity Instructions" page 12 of "Safety Instructions" page 6 in the device instruction manual.
- Refer to the "Floating License Key - License management for software options" instruction manual (if applicable)
- Refer to device specific DICOM interface description (if applicable)

The intended flow of information between PEMS, the IT-Network and other devices in the IT-Network and the intended routing through the IT-Network

- License handling from local license server to PEMS and vice versa
- Storage and data export to local network storage and loading from local network storage
- Printout to local printer

List of hazard situations that result from the IT-Network being unable to provide the features that are required to fulfill the purpose of integrating the PEMS into to meet the IT-Network:

- Loss of data
- unsuitable data exchange
- Data corruption
- unsuitable temporal data allocation
- unexpected data reception
- unauthorized access to data



Connection of the PEMS to an IT-Network that includes other equipment could result in previously unidentified risks to patients, operators or third parties.

The responsible organization should identify, analyze, evaluate and control these risks.

Subsequent changes to the IT-Network could introduce new risks and require additional analysis.

Changes to the IT-Network include:

- changes in IT-Network configuration
 - connection of additional items to the IT-Network
 - disconnecting items from the IT-Network
 - update of equipment connected to the IT-Network
-

Manufacturer and Service Address

Headquarters:
OCULUS Optikgeräte GmbH
Münchholzhäuser Straße 29 • 35582 Wetzlar • GERMANY
Tel. +49 641 2005-0 • Fax +49 641 2005-295
E-Mail: export@oculus.de • www.oculus.de

G/70020/XXXX/EN
Lot:

