

# OCULUS

Pentacam® | Pentacam® HR

Anterior Segment Tomography



INSTRUCTION MANUAL



## Preface

The Pentacam® / Pentacam® HR / Pentacam® HR Premium (hereafter called: Pentacam) has been manufactured and tested according to strict quality criteria.

To ensure safe operation, it is essential that you use the device correctly. For this reason you should familiarise yourself thoroughly with the contents of this instruction manual before operating the device. In particular, pay attention to the safety instructions.

- The operating concept of the Oculus Pentacam® and Pentacam® HR is basically identical.
- This instruction manual describes how to manage patient data, the default settings of the Pentacam® program and the measuring process.
- Additional functions pertaining to the Pentacam® HR (high resolution) are indicated accordingly.
- The Pentacam® reference manual contains information supplementing the description of the operating concept.

Due to ongoing development, the diagrams shown may depict minor changes to the actual device delivered.

If you have any queries or would like additional information about your device, do not hesitate to call or send us an email or a fax. Our service team will gladly assist.

OCULUS Optikgeräte GmbH

Item number: 10028075

Revision 00

Release: 30.11.2023

## Table of Contents

<b>1</b>	<b>Delivery and Deliverables</b> .....	<b>7</b>
<b>2</b>	<b>Symbols</b> .....	<b>9</b>
2.1	On the device / name plate.....	9
2.2	On the packaging.....	10
<b>3</b>	<b>Structure of the Documentation</b> .....	<b>11</b>
<b>4</b>	<b>Safety Instructions</b> .....	<b>12</b>
4.1	Icons Used in this Manual.....	12
4.2	Safety Instructions for Use.....	13
4.3	Instructions for Operating Personnel .....	13
4.4	Transport and Storage Instructions.....	13
4.5	Instructions for Setup and Connection.....	13
4.6	Patient environment information.....	14
4.7	Instructions for the operation of a ME system.....	15
4.8	Instructions for Operation.....	15
4.9	Instructions for Maintenance.....	16
4.10	Instructions for Disassembly and Disposal.....	16
4.11	Instructions on Electrical Safety.....	16
4.12	Instructions on Cyber Security .....	17
4.12.1	Precautions for access control of the computer.....	17
4.12.2	User Responsibility .....	18
4.12.3	Reporting Device Security or Privacy Breaches.....	18
4.12.4	Recovering from Compromised Accounts or Devices.....	18
4.12.5	Unavailable Service .....	18
4.12.6	Precautions if the computer is connected to a LAN or internet network.....	19
<b>5</b>	<b>Intended Purpose</b> .....	<b>20</b>
5.1	Intended Use .....	20
5.2	Intended Medical Indication .....	20
5.3	Contraindication .....	20
5.4	Possible side effects.....	20
5.5	Intended users .....	21
5.6	Patient group .....	21
<b>6</b>	<b>Device Description</b> .....	<b>22</b>
6.1	Overview of the device components .....	22
6.2	Applied parts.....	23
6.3	Functionality of the Pentacam® / Pentacam® HR.....	23
<b>7</b>	<b>Setup and Installation</b> .....	<b>25</b>
7.1	Setup .....	25

7.2	Installation and Operating Conditions.....	25
7.3	Electrical Connection.....	26
7.4	Switching On.....	27
7.5	Switching Off.....	27
7.6	Software Installation on separate PCs.....	27
<b>8</b>	<b>Pentacam® -Program and Scan Menu .....</b>	<b>28</b>
8.1	Menu Bar in the Pentacam® -Programm.....	28
8.2	Screen Layout Scan Menu.....	28
8.2.1	Scheimpflug image settings.....	30
8.2.2	Parameters applicable only to the Pentacam® HR.....	31
8.3	Loading previous examinations.....	32
8.4	Online help.....	32
8.5	Information for recording Scheimpflug images.....	32
<b>9</b>	<b>Measuring Procedure.....</b>	<b>34</b>
9.1	Default settings.....	34
9.2	Darkening the room/dark sheet.....	35
9.3	Rough adjustment.....	35
9.4	Fine adjustment.....	38
9.5	Quality Specifications.....	39
<b>10</b>	<b>Patient Data Management.....</b>	<b>42</b>
10.1	Starting Patient Data Management.....	42
10.2	Entering a New Patient.....	43
10.3	Selecting an Existing Patient.....	43
10.4	Extended Patient Search: [Extended] Checkbox.....	45
10.5	Rename Patient Data.....	45
10.6	Exporting Patient Data.....	45
10.7	Importing Patient Data.....	47
10.8	Data Backup.....	48
10.8.1	Backup Data.....	48
10.8.2	Reconstructing Data.....	49
10.8.3	Automatic Backup.....	49
<b>11</b>	<b>Cleaning, Disinfection and Maintenance.....</b>	<b>50</b>
11.1	Intervals for Cleaning, Disinfection and Maintenance.....	50
11.2	Cleaning.....	50
11.2.1	Cleaning the Housing.....	50
11.2.2	Cleaning the Chin-Forehead Rest.....	51
11.2.3	Cleaning the illuminated slit.....	51
11.3	Disinfection.....	51
11.4	Test measurements.....	52
11.5	Maintenance.....	52
11.6	Attaching Paper to the Chin Rest.....	53
<b>12</b>	<b>Troubleshooting.....</b>	<b>55</b>

<b>13 Transport and Storage</b> .....	<b>56</b>
13.1 Storage conditions.....	56
13.2 Transport conditions .....	56
13.3 Disassembly .....	57
<b>14 Disposal</b> .....	<b>58</b>
<b>15 Terms of Warranty and Servicing</b> .....	<b>59</b>
15.1 Terms of Warranty.....	59
15.2 Assumption of Liability for Functions and Damage.....	59
<b>16 Technical Data</b> .....	<b>60</b>
<b>17 Annex</b> .....	<b>62</b>
17.1 Electromagnetic Compatibility .....	62
17.2 Guidance and Manufacturer's Declaration - Electromagnetic Emissions and Immunity for the Pentacam® / Pentacam® HR.....	63
17.3 Description of the Connection .....	67
17.4 Data sheet HEMG 49-S240210-7 (05150150).....	68
17.5 Instructions for integration into an IT-Network .....	70

# 1 Delivery and Deliverables

Product and accessories	Order number
Version	
■ Pentacam®	70700
■ Pentacam® HR	70900
x-y base	70480
Support plate	78050
Cograil	027051701004
Cover	027051701005
Sliding plate	017051701007
Chinrest paper	65313
Head and chin rest	70518
Accessories Package Pentacam® / Pentacam® HR	78005
■ Power supply	05150150
■ Dark sheet	017070000006
■ Washing manual	10001961
■ Wire clip	027075000004
■ Hexagon screwdriver	05520010
User Information:	
■ Instruction Manual	G/70700/EN
■ User Guide	UG/70700/EN
■ Software Installation	SI/50000/EN
Additional accessories:	
■ Dustcover	026010005001
■ Hard drive, package	70005
■ Y-cable with galvanic isolation 2 m (for Basic)	017090000052
■ Med. secure isolator + USB connection (for HR)	70002
■ Extension cable for Y cable 4 m	10002173
■ Electric cable EU	05200320
■ Electric cable Switzerland	05200322
■ Electric cable Argentina	05200323
■ Electric cable US	05200210
■ Electric cable GB	05200211
■ Electric cable Australia	05200212

Software module	Order number
Standard software package Pentacam®:	70725
■ Floating License Key with manual	77900 SI/77900/.../en
■ Viewing License Pentacam®	-
■ Fast Screening Report software modul	70927
■ Full Sequence Measurement	10006911
■ Pentacam® Data-USB-Stick	017090901001

Optional software modules	Order number
IOL Calculator (only for Pentacam® HR)	70110
Contact Lens fitting incl. Fourier Analysis	70726
3D pIOL Simulation Software and Aging Prediction (only for Pentacam® HR)	70928
Belin/Ambrósio Enhanced Ectasia Display	70728
Holladay Report and EKR65 Detail Report	70729
PNS and 3D-Catarakt Analysis	70727
Corneal Optical Densitometry	70926
CSP pro (only for Pentacam® HR)	10013369
Module DICOM PACS	70718
Software Package Cataract: <ul style="list-style-type: none"> <li>■ Catarakt Software</li> <li>■ PNS and 3D-Catarakt Analysis</li> <li>■ Zernike Analysis</li> </ul>	70820
Software Package Refractive: <ul style="list-style-type: none"> <li>■ Refractive Software</li> <li>■ Corneal Optical Densitometry</li> </ul>	70810
Software package Optometric Screening: <ul style="list-style-type: none"> <li>■ Shows 2 Exams</li> <li>■ 4 Maps Selectable</li> <li>■ Corneal Optical Densitometry</li> <li>■ Belin/Ambrosio Enhanced Ectasia Display</li> </ul>	10009399
Software package Contact Lens (only for Pentacam® HR): <ul style="list-style-type: none"> <li>■ CSP pro</li> <li>■ Compares 4 Exams</li> <li>■ Wavefront Zernike</li> <li>■ Contact Lens Fitting</li> </ul>	10009398

We reserve the right to change the scope of delivery in line with ongoing technical development.

- ➔ If you find transport damage upon delivery, immediately file a claim with the transport company.
- ➔ Have the damages noted on the bill of lading, so that your claim for damages can be handled properly.

For more information regarding shipping and handling, see [sec. 13, page 56](#).

## 2 Symbols

### 2.1 On the device / name plate

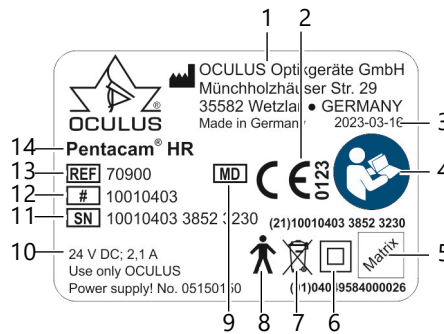









Fig. 2-1: Name plate (example)

No.	Symbol	Description	No.	Symbol	Description
1		Name and address of manufacturer	8		Applied part Type B
2		CE conformity and number of the notified body	9		Medical device
3		Date of manufacture	10		Power supply
4		Follow instruction for use	11		Serial number
5		UDI number (example), consisting of: UDI-DI (Device-Identification) UDI-PI (Product Identifier) and machine-readable matrix code	12		Model number
6		Safety class	13		Article number
7		Disposal in household trash is prohibited	14		Device type

## 2.2 On the packaging

Symbol	Description
	Keep dry
	This way up
	Fragile
<b>Transport</b>	
	Limit of temperature for transport
<b>Storage</b>	
	Limit of temperature for storage
	Limit of humidity
	Limit of air pressure

## 3 Structure of the Documentation

A folder containing documentation is supplied with your Pentacam<sup>®</sup> / Pentacam<sup>®</sup> HR:

- **Short Guide:** This document describes the measurement process and can be used as a checklist. This document supports you when carrying out measurements so that you do not forget any important work steps and the measurement results can therefore be evaluated correctly.
- **Instruction Manual:** The design of the unit is described in detail in this document. The instruction manual also gives you general information about working with the Patient Data Management system and all safety-related instructions for use of the Pentacam<sup>®</sup> / Pentacam<sup>®</sup> HR.
- **User Guide:** All features of the examination and analysis software are described in the User Guide, along with detailed information about the Patient Data Management system.
- **Software Installation:** The introduction to the Software Installation describes how to install the Pentacam<sup>®</sup> / Pentacam<sup>®</sup> HR software and the associated drivers.
- **Manual Floating License Key:** information on the use of the Pentacam<sup>®</sup> / Pentacam<sup>®</sup> HR within networks.

## 4 Safety Instructions

All safety-related instructions for use of the Pentacam® / Pentacam® HR are given in the Instruction Manual for the unit. It is imperative that you read and understand the whole Instruction Manual before you use the Pentacam® / Pentacam® HR.



- ➔ Carefully read through the Instruction Manual.
- ➔ Keep the Instruction Manual in good condition near the device.
- ➔ Observe the legal regulations with regard to accident prevention.

### 4.1 Icons Used in this Manual



#### Warning

Identifies a potentially dangerous situation which may cause serious injury.



#### Caution

Identifies a potentially dangerous situation which may cause minor injury.



#### Attention

Identifies situations which may cause damage to the device or incorrect test results.



Indicates important instructions for use and important information about the device.

- > This symbol denotes menu paths and screen shots. Example for starting a new examination:  
Pentacam® / Pentacam® HR > Examination > Scan  
which means:
  - ➔ Select the "Examination" menu from the menu bar.
  - ➔ Select the menu item "Scan".

## 4.2 Safety Instructions for Use



### Caution

Personal injury or property damage due to improper operation

→ Observe the following safety instructions.



### Caution

Personal injury or property damage due to equipment modifications that could jeopardize safety

- No modifications may be made to this device without the permission of the manufacturer. Only the OCULUS service and authorized dealers are allowed
- to modify the device or the associated lifting table
  - to install software and software updates.

Any serious-incident that has occurred in relation to the device should be reported to the manufacturer ([vigilance@oculus.de](mailto:vigilance@oculus.de)) and the competent authority of the region in which the user and/or patient is established.

## 4.3 Instructions for Operating Personnel

Refer to the notes in chap. "5.5 Intended users" on page 21.

## 4.4 Transport and Storage Instructions

Refer to the notes in chap. "13 Transport and Storage" on page 56.

## 4.5 Instructions for Setup and Connection

- Only OCULUS or an authorized dealer is allowed to set up and to connect the device.
- Do not use or store the device in rooms that are humid, see chap. "13 Transport and Storage" on page 56.
- Keep the device away from water that may drip, splash or spray on it, and make sure that no liquids can get into the device. Do not place any containers holding liquids in the vicinity of the Pentacam® / Pentacam® HR.
- Germany: Only operate the device in rooms used for medical purposes after they have been set up according to the VDE Regulation 0100-710.
- Do not operate the devices included in the delivery in areas where explosions may occur, or in proximity to flammable anesthetics or volatile substances such as alcohol, benzine or similar products.
- Set up the device so that the power plug is easy to access. That way, you can easily disconnect it from the power supply for any repairs or maintenance work.

- Do not force any plug connections.  
If you are unable to make a plug connection, check whether the plug fits the socket.  
If you detect damage to the connection, you should let authorized dealer repair the damage.
- Only use a device which is mounted at the lifting table properly.

## 4.6 Patient environment information

Patient environment is the area where patients can come into contact with any part of a medical electrical equipment (ME equipment) or with another person being in contact with the ME equipment.

- Only use devices that are compliant with IEC 60601-1 in the patient environment.

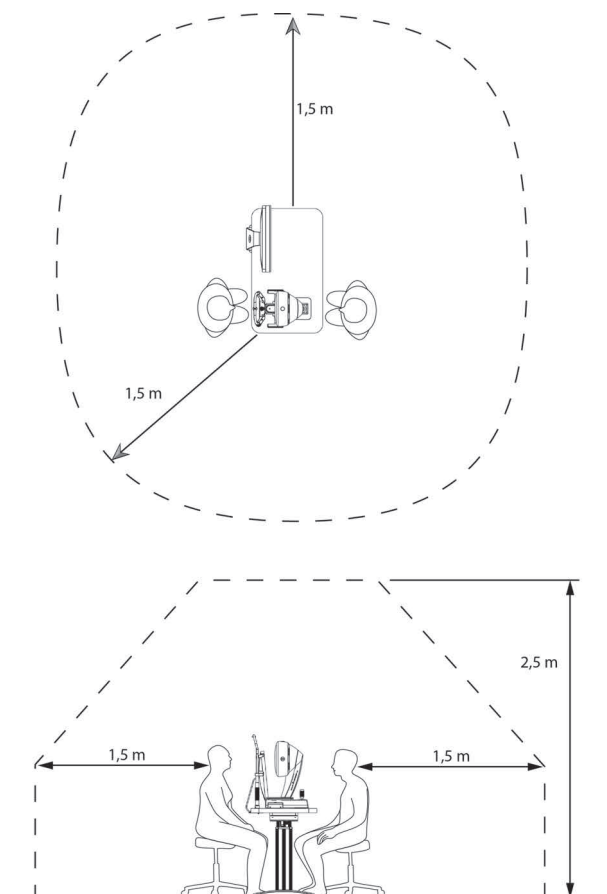

Fig. 4-1: Patient environment

#### 4.7 Instructions for the operation of a ME system

The device and a connected computer form together a medical electrical system (ME system) according to IEC 60601-1. If you connect additional devices, such as, for example a printer, those devices become part of the ME system.

- ➔ All devices of the ME system must comply with the requirements of IEC 60601-1 or IEC 62368-1.

#### 4.8 Instructions for Operation

- Before first use: Let OCULUS or an authorized dealer train you in the operation of the device.
- Never operate a damaged device.
- Only operate the device with the original accessories supplied by us and only when the unit is in technically perfect condition.
- Do not cover the ventilation openings.
- Do not touch the patient and the device at the same time.
- Make sure that the device cannot tip over by leaning against it or sitting on it.
- Do not put the device, including rechargeable battery or cable, down onto devices that produce heat, heaters (for example radiators), microwaves or similar.
- Only operate the device if you have understood the operating instructions.



##### ISO 15004-2:2007 Group 2 instrument

A graph showing the relative spectral output of the instrument between 305 nm and 1100 nm when the instrument is operating at maximum light intensity and maximum aperture will be provided by OCULUS on request. The spectral output will be shown for the beam after it exits the instrument.



##### Caution

The light emitted from this instrument is potentially hazardous. The longer the duration of exposure and the greater the number of pulses, the greater the risk of ocular damage. Exposure to light from this instrument when operated at maximum output will exceed the safety guideline after 225 treatments.

For US:



##### Caution

The light emitted from this instrument is potentially hazardous. The longer the duration of exposure, the greater is the risk of ocular damage. Exposure to light from this instrument when operated at maximum intensity will exceed the recommended maximum exposure (RME) of 2.2 J/cm<sup>2</sup>, unless additional action is taken by the user to minimize exposure, after 49 treatments (per patient eye). The risk of retinal injury at an exposure of 2.2 J/cm<sup>2</sup> is not high, but because some patients may be more susceptible than others, caution is advised if this radiant exposure value is exceeded. However, because of a significant

risk of injury at exposures exceeding  $10 \text{ J/cm}^2$ , the user should avoid exposures longer than 225 treatments (per patient eye).

## 4.9 Instructions for Maintenance

In order to retain the high measurement accuracy of the device OCULUS Optikgeräte GmbH recommends to perform a maintenance service every two years or after 25000 scans. A corresponding message appears.

Please observe the Information in chap. "11 Cleaning, Disinfection and Maintenance" on page 50.

If an error occurs which you cannot correct, label the device as being "out-of-order" and contact our service department.

## 4.10 Instructions for Disassembly and Disposal

- When disconnecting electrical connections, pull on the respective plug and not on the cable itself.
- Dispose of the device according to legal regulations.

## 4.11 Instructions on Electrical Safety



### Caution

Risk of personal injury or damage to property due to an incorrect level of safety

Connecting the Pentacam® / Pentacam® HR with its non-medical electrical equipment (e.g. data processing equipment) to a medical electrical system must not result in a patient safety level below that prescribed by IEC 60601-1. If making this connection leads to the leakage current threshold being exceeded, protective measures including a circuit breaker must be in place.

- ➔ Ensure that connections with non-medical devices are made correctly.
- ➔ Only use the power adapter listed in the packing list.
- ➔ Use only a computer that meets the specifications given in this instruction manual, *sec. 16, page 60*.



### Caution

#### **Risk of personal injury or material damage caused by unsafe multiple socket extension cord**

If you use a multiple socket extension cord to connect the device to the power supply, you must heed the following information:

- ➔ Use an extension cord that complies with the requirements of IEC 60601-1, section 16.

- Do not place the multiple socket extension cord on the floor.
- Do not use more than one multiple socket extension cord.
- Plug only the device and the computer that is being used with the unit (if applicable) into the multiple socket extension cord.
- If you are using a multiple socket extension chord it has to be supplied with a isolation transformer.
- If you are using a new computer for the device, you must have the electrical safety checked. Call OCULUS Service for this purpose.



**Caution**

**Risk of personal injury or damage to property due to electromagnetic interference**

Portable and mobile RF communications equipment can affect medical electrical equipment see chap. "17.1 Electromagnetic Compatibility" on page 62.

- Make sure that portable and mobile RF communications equipment do not cause interference.
- Recommendation: Maintain a minimum distance (refer "17.1 Electromagnetic Compatibility" on page 62). If the distance is shorter, you must ensure that the Pentacam® / Pentacam® HR functions correctly.

## 4.12 Instructions on Cyber Security



The device does not require a network or internet connection to work. The device itself was not designed to connect via a coupled computer to the internet or other network, or to portable media, as the device does not require a network or internet connection to function.

User who elect to connect the device coupled computer to the internet or other network for other purposes are responsible for ensuring that it is done so in a controlled manner.

### 4.12.1 Precautions for access control of the computer

To ensure cyber security when using the device:

- Secure the device against unauthorized access by unauthorized persons.

The following security measures should be considered:

- Secure the computer with a password (for example at Windows start up).
- Choose a complex password: A good password should be at least eight characters long and are not in the dictionary. In addition to letters, it should also include numbers and special characters.
- Do not choose a name or device name for a password (for example "Pentacam").
- Change the password regularly.
- Do not note the password in an accessible location.

- Use different passwords for different users.
- Enable the screen saver and use the option for the necessity of reentering the password when exit the screen saver.
- Choose an adequate time setting for starting the screen saver if software session is inactive (e.g. 10 minutes). Adequate time setting should consider duration of examination, number of patients, time between examinations, use of other devices in the examination room, several user, etc.
- Lock the computer if you are leaving the workstation (shortcut: 'windows logo key' + 'L').
- Contact your administrator if necessary.

#### 4.12.2 User Responsibility

User names or passwords must not be shared with colleagues or others, even if they are permitted by law and provider policy to view the same type of information (e.g. two operators reviewing the same patient samples).

Operators have access to sensitive patient data (ePHI). No snapshots, screen shots or images (e.g. with another device) of information displayed via the device may be taken.

Operators should not enter any identifying data into the device. All the data on the device should be anonymized and refer to the sample ID and not to the patient.

#### 4.12.3 Reporting Device Security or Privacy Breaches

Operators must contact their local IT department and disclose any suspected or confirmed compromised user accounts, and any other privacy or security breaches.

#### 4.12.4 Recovering from Compromised Accounts or Devices

When accounts are considered compromised, devices are lost, or unauthorized access is discovered or suspected, the Healthcare Organization's IT network administrators suspend and modify the user login criteria and issue new login credentials for the user to access their account securely.

#### 4.12.5 Unavailable Service

Users should report unavailable service or prohibited access to information to their local Healthcare Organization's IT department.

#### 4.12.6 Precautions if the computer is connected to a LAN or internet network



Always use a wired connection to transfer examination data from the device to the PC.  
Do not use wireless technologies.



Please observe the regulations, instructions and recommendations of your responsible Office for Information Security for the protection of critical infrastructures.

- Do not connect with the internet while using the device. It is considered misuse!
- If you elect to connect the computer to the internet for other purposes you are responsible for ensuring data security.

If you connect the computer to the LAN or internet, you are responsible for ensuring data security.

Observe therefore:

- Prefer wired connections of the computer to the network.
- If you are using Wi-Fi connections nevertheless, please ensure the usage of adequate security methods (for example WPA2/AES – Wi-Fi Protected Access / Advanced Encryption Standard – with a strong network key).
- The usage of a firewall (software or hardware) is recommended.
- Follow the instructions for integration into an IT network (see chap. "17.5 Instructions for integration into an IT-Network" on page 70).

## 5 Intended Purpose



The Pentacam is intended exclusively for the purpose stated in this manual and in compliance with the safety instructions.



**For the US-Market only:** Federal law restricts this device to sale by or on the order of a physician, or with the descriptive designation of any other practitioner licensed by the law of the State in which he practices to use or order the use of this device.

### 5.1 Intended Use

The OCULUS Pentacam® / Pentacam® HR is designed to take photos of the anterior segment of the eye which includes the cornea, pupil, anterior chamber and lens of the eye to evaluate:

- corneal shape,
- analyse condition of the lens (opaque crystalline lens),
- analyse the anterior chamber angle,
- analyse anterior chamber depth,
- analyse the volume of the anterior chamber,
- analyse anterior or posterior cortical opacity,
- analyse the location of cataracts (nuclear, subcapsular and or cortical), using cross
- slit images with densitometry and
- corneal thickness.

### 5.2 Intended Medical Indication

The Pentacam® / Pentacam® HR is indicated as an aid to screen several eye diseases for example, but not limited to:

- Keratoconus classification and progression
- Early ectatic diseases
- Quantification of optical corneal density
- Quantification of optical lens density
- Close angle glaucoma
- Planning support for IOLs.

### 5.3 Contraindication

None known.

### 5.4 Possible side effects

- After-image
- Headache
- Vertigo
- Tearing eyes

## 5.5 Intended users

The Pentacam® / Pentacam® HR is intended exclusively for use in:

- ophthalmology practices
- clinics
- opticians or optometrists

The Pentacam® / Pentacam® HR is intended for use by trained personnel:

- Who can ensure proper handling based on their knowledge, training and practical experience.
- Who have been instructed by OculUS personnel or an authorized dealer prior to commissioning.

## 5.6 Patient group

- Children from 3 years up to not limited.
- No restrictions on weight.
- Patient is awake.
- Patient is able to understand and to look into a fixation target.

## 6 Device Description

### 6.1 Overview of the device components

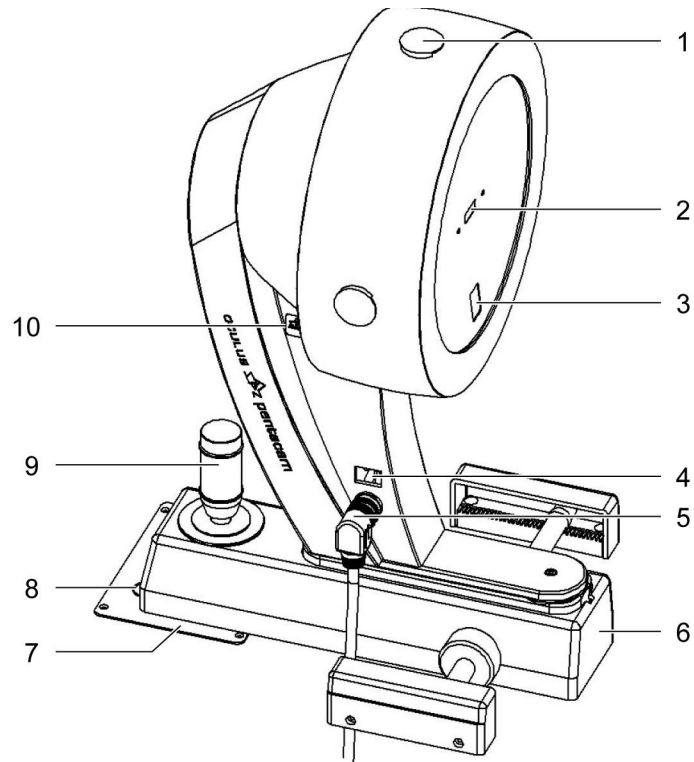

Fig. 6-1: Device components

No.	Description
1	Ventilation opening
2	Measuring window
3	Camera opening
4	On/off switch with indicator light
5	Y-cable connector
6	Cross slide
7	Sliding plate
8	Circular markings on sliding plate
9	Joystick
10	Nameplate

## 6.2 Applied parts

The chin and head rest are applied parts of type B.



Fig. 6-2: Anwendungsteile

No.	Description
1	Head rest
2	Chin rest

## 6.3 Functionality of the Pentacam® / Pentacam® HR

While rotating around the eye, the Pentacam® captures Scheimpflug images of the anterior eye segment through varying axes. The Scheimpflug images created during an examination are transmitted to the connected PC.

Up to 50 (Pentacam) or 100 (Pentacam HR) Scheimpflug images can be captured within maximum two seconds.

Up to 25,000 (HR: 138,000) genuine height values are measured and analysed from the Scheimpflug images.

The Scheimpflug images are the basis for the height data which are used to calculate a mathematical 3D model of the anterior eye segment. At same time any eye movements are recorded and taken into account.

A quality specification (QS) lets you gauge the quality of the measurement taken.

The mathematical 3D model, corrected for eye movements, provides the basis for all subsequent analysis.

The topography of the front and rear surfaces of the cornea and the pachymetry are calculated and displayed from limbus to limbus for the entire surface of the cornea.

An analysis of the anterior chamber provides the basis for calculating the chamber angle, chamber volume and chamber depth.

Densitometry of the cornea and lens automatically produces quantified values.

Colour images displayed on the screen show the results of the measurement.

A rotatable 3D model displays the front and rear surfaces of the cornea, the iris and the lens.



**Caution**

OCULUS Optikgeräte GmbH shall not be liable in any form for further use of the data recorded by a Pentacam® and for the evaluations it has calculated.

---

## 7 Setup and Installation

### 7.1 Setup



#### Attention

Incorrect installation may result in incorrect measurements or even damage to the device.

- ➔ Have the device set up and connected by our service department or by a specialist authorized by OCULUS.
- ➔ Set up the device so that it cannot fall over. Mount the device on an examination table.
- ➔ Set up the device so that it is protected from dripping, splashing or spray water.



#### Attention

Damage to the device due to incorrect handling

- ➔ Do not expose the device to any vibrations, shocks, contaminants, moisture, or high temperatures.
- ➔ Handle the device with care.

- Set up the Pentacam® / Pentacam® HR so that the power plug is easy to access. That way, you can easily disconnect it from the power supply for any repairs or maintenance work.
- Place the device so that direct light cannot affect the measurement.
- Make sure the examination is free from light reflections. To achieve this, darken the examination room.

### 7.2 Installation and Operating Conditions

Temperature	+10 – +35 °C
Air humidity	30 – 90 %
Air pressure	800 – 1060 hPa

- Before installation, compare the transport and storage temperature with the temperature in the intended installation room.
- The difference between the transport and storage temperature and the installation room should not be more than 10°C to prevent the internal optics from misting up.

### 7.3 Electrical Connection



**Caution**

If there are temperature differences between the transport and storage temperature and the installation room, especially if the temperature exceeds 10°C, the optics may fog up and/or condensation may form.

- Leave the device unused in the installation room for at least 6 hours before connecting it so that the device can adjust to the ambient temperature.



**Caution**

Electrical safety hazard

- Do not use the device directly next to other devices.
- Do not stack the device with other devices.
- Only use the power supply unit supplied or one identical to the one specified in the Tech. Data (see chap. "16 Technical Data" on page 60).
- Do not place any heavy objects or the device itself on the power cable.
- If you use a multiple socket to connect the device, the multiple socket must comply with the requirements of IEC 60601-1.
- Do not place the power strip on the floor.
- Do not expose the mains cable or the multiple socket to high temperatures. Do not place on heaters!
- Use a maximum of one multiple socket.
- Only connect the device and, if applicable, the associated computer to this multiple socket.
- Use a socket outlet that has a faultless protective conductor connection.



No.	Description
1	On / Off switch
2	Plug of the Y-cable

Fig. 7-1: Electrical Connection



**Attention**

If the device is not connected correctly and voltage is applied, the device may be damaged after a short time.

- Do not use excessive force to connect electrical connections.
- Observe the specifications on the name plate.
- If the plug is defective, contact OCULUS Service or an authorized dealer to repair the damage.

- Plug the connector of the Y-cable into the jack and tighten the connection. Make sure that the plug is inserted in the correct position.
- Firmly tighten the connection.
- Connect the Y-cable to the PC/laptop and the power adapter.

## 7.4 Switching On



### Caution

Risk of incorrect measurements due to improper setup

- Before taking measurements, the device has to be switched on, at least for one hour.

- The first step is to switch on the PC or laptop.
- Then turn on the device with the on/off switch (position ON). The LED on the switch lights up green, [fig. 7-1, page 26](#).

## 7.5 Switching Off

- Close the Pentacam program and close the Patient Data Management.
- Shut down the Windows operating system.
- Turn the device off with the on/off switch (OFF position)

## 7.6 Software Installation on separate PCs

The Pentacam-Software is network compatible. This makes it possible to install the Pentacam® Software on several PCs, connected in a local network.

Make sure, that all PC in a network do have the same Pentacam® software version installed.

A Floating License Key is part of every Pentacam® shipment. Please ensure a proper installation based on the Manual for the Floating License Key.

This allows an interactive parallel evaluation of the Pentacam® exams based on the released optional software packages and modules.

The demo examinations included can be viewed on every computer having the Pentacam® software installed.

For more detailed information contact your authorized dealer or our service department.

## 8 Pentacam® -Program and Scan Menu

The device is safe to use if no error message is displayed after starting the software when the device is connected and switched on (e.g. component failure, camera not recognized, missing reference data, etc.). After starting, the patient data management opens (see chap. "10 Patient Data Management" on page 42).



The Pentacam® program is not to be used to dictate therapy without professional correlation with other clinical findings and diagnostic tests.

### 8.1 Menu Bar in the Pentacam®-Programm

To start the Pentacam® program from the patient data management click on the Pentacam® button.

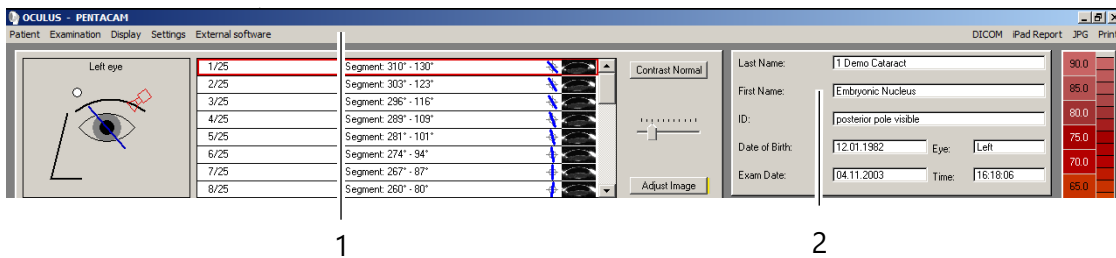

Fig. 8-1: Pentacam® program menu (upper section)

No.	Description
1	Menu bar
2	Examination and Patient data

### 8.2 Screen Layout Scan Menu

Switching from the Pentacam® program to the Scan menu:

- ➔ In the Pentacam® program (fig. 8-1, page 28) select the menu item [Examination] and click [Scan].

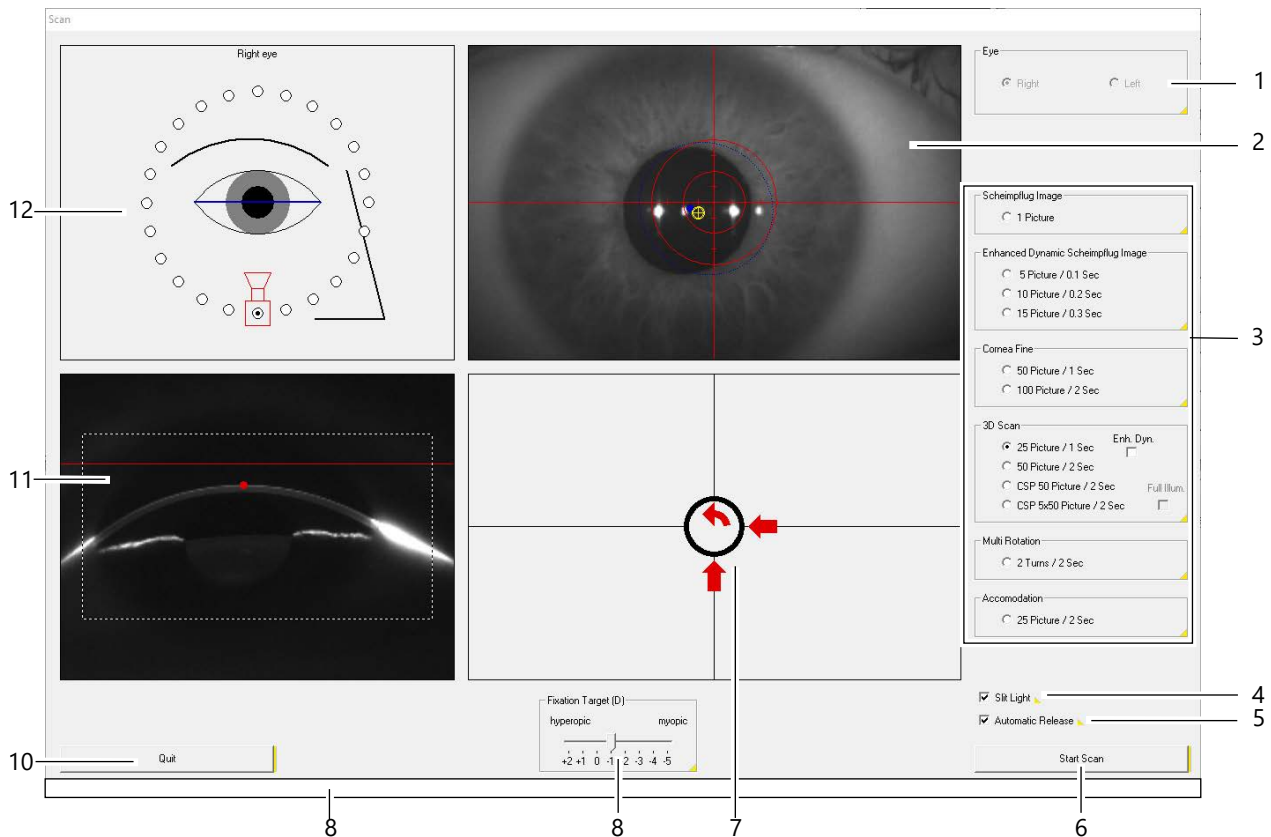

Fig. 8-2: "Scan" screen ("HR" model)

No.	Description
1	"Eye" field
2	Pupil image
3	"Image Options" area
4	[Slit Light] checkbox
5	[Automatic Release] checkbox
6	[Start Scan] button
7	Adjustment window
8	Fixation target
9	Message about device, if necessary
10	[Quit] button
11	Scheimpflug Image
12	"Orientation" field

- The eye currently being examined is detected automatically and is displayed in the "Eye" field (1).
- The Pupil Image (2) shows the vertical / horizontal positioning of the Pentacam. The object is to position the yellow dot marking the apex of the cornea in the centre of the crosshairs. The blue dot marks the centre of the pupil, while the blue ring frames the pupil.

- You can set the type of image required for the respective examination in the "Image Options" area (3) ([sec. 8.2.1, page 30](#) and [sec. 8.2.2, page 31](#)).
- Click the [Slit Light] checkbox (4) to activate/deactivate the blue light for illuminating the eye.
- Click the [Automatic Release] checkbox (5) to activate automatic measurement.
- Clicking the [Start Scan] button (6) activates manual measurement. You can also use the Return key.
- Inside the adjustment window (7), there are arrows showing you the direction in which you must move the Pentacam® to activate automatic measurement (Automatic Release).
- This line (8) shows messages about the device, for example if a service is due.
- Click the [Quit] button (9) to abort the measurement.
- The Scheimpflug image (10) shows the distance between Pentacam® and patient. The objective of this setting is to move the red dot on the front surface of the cornea so as to coincide with the red line.
- The "Orientation" field (11) shows the respective position of the camera and the eye, which is currently being examined.
- The "Fixation Target" setting is a parameter used only on the Pentacam® HR ([sec. 8.2.2, page 31](#)).

### 8.2.1 Scheimpflug image settings

You can set the number and type of images required for the respective examination in the "Image Options" box (3).

#### "Scheimpflug Image" group box

- If you activate this option, the camera records only one Scheimpflug image. You can freely select the camera position you require by clicking the white rings in the "Orientation" field (11).

#### "Enhanced Dynamic Scheimpflug Image" group box

- Use this option to make the camera record either 5, 10 or 15 Scheimpflug images, with the camera remaining in the same position. Image averaging is carried out on the recorded images to minimise background noise. Only one Scheimpflug image is displayed. You can freely select the camera position you require by clicking the white rings in the "Orientation" field. This type of image is suitable for a purely densitometric assessment of the lens.

### "3D Scan" group box

- Use this option to select how many images you want the camera to record per scan. The difference is in the duration of the examination and the number of measuring points that are evaluated. A scan comprising 50 images takes longer, of the patient provides the highest amount on measured elevation data. This type of examination is used for evaluating the cornea and anterior chamber.
- You can also select whether or not a CSP scan (Cornea scleral profile) should be recorded. A CSP scan measures both the cornea and the sclera profile, see also [sec. 9.5, page 39](#).

## 8.2.2 Parameters applicable only to the Pentacam® HR



### Note

The parameters described below apply only to the Pentacam® HR.

The Pentacam® HR has additional options for selecting image types (see Scan Menu "Image Options" box (3)).

### "Cornea Fine" group box

- Select this option for a more detailed image of the cornea. The camera does not capture the deeper-lying layers of the front part. You can select 50 Scheimpflug images for a recording time of one second, or 100 Scheimpflug images for a recording time of two seconds.

### "Multi Rotation" group box

- If you select this option, the camera will record Scheimpflug images from 50 different positions while performing a full rotation twice around the eye.

### "Accommodation" group box

- If you select this option, the camera will take a total of 50 Scheimpflug images. While the camera is recording the images, the "Fixation Target" shifts constantly from -5 D to +2 D. The camera records the Scheimpflug images from a pre-selected camera position.

### [Enh. Dyn.] checkbox in the "3D Scan" group box

- Activating the "Enh. Dyn." function prolongs the exposure time per Scheimpflug image. The advantage is a clear representation of phakic IOLs. If you select this recording mode, colours and evaluations are neither calculated nor displayed.

### "Fixation Target" slider

- Use of the "Fixation Target" enables a better fixation of the patient. For this, the active "Fixation Target" , for example the LED blinking red in the middle of the blue slit, can be shifted in steps of 0.5 D. The object is to offset defects in the patient's vision and ensure a simpler method of fixation.

## 8.3 Loading previous examinations

- ➔ Select the menu item [Examination] and click [Load]. The dialog box "Load Examination" appears.
- ➔ Make a selection by clicking the required examination.
- ➔ Confirm your selection by clicking [OK], or by double clicking. The Pentacam® program will load the examination you have selected.

## 8.4 Online help

The Pentacam® program provides you a direct help. You can recognize that by a yellow mark.

Examples:



Open the direct help by clicking on the yellow mark.

## 8.5 Information for recording Scheimpflug images

Type of examination	Examination mode	Images	Automatic measurement	Notes
Topography	3D scan	25-50	Yes	
Pachymetry	3D scan	25-50	Yes	
Analysis of the anterior chamber	3D scan	25-50	Yes	Do not apply mydriatic drops.
Artificial lenses (general)	Enhanced dynamic (for HR in the "3D scan" examination mode)	15	Yes	If the pupil is insufficiently dilated, apply mydriatic drops. Use 3D scan for measurements.
Measuring functions	3D scan	25-50	Yes	If the pupil is insufficiently dilated, apply mydriatic drops.
Densitometry	3D scan Enhanced dynamic	25-50 5-15	No	Use the same number of images to enable a progress check and apply mydriatic drops.

### Specific instructions for the Pentacam® HR

Type of examination	Examination mode	Images	Automatic measurement	Notes
IOLs, ICLs, PIOLs	3D scan for PIOLs, possibly longer exposure	25-50	Yes	If the pupil is insufficiently dilated, apply mydriatic drops

## 9 Measuring Procedure



### Attention

Risk of incorrect measurement due to incorrect use

- Before first use: Let OCULUS or an authorized dealer train you in the operation of the Pentacam® / Pentacam® HR.



### Attention

Risk of incorrect measurements due to improper setup

- Before taking measurements, the Pentacam® / Pentacam® HR has to be switched on, at least for one hour.



### Attention

Due to small movements of the patient or caused by a wheelchair, the patient is no longer positioned appropriately to the Pentacam® / Pentacam® HR, which can lead to incorrect measurements.

- Perform a Pentacam® / Pentacam® HR scan only if the patient sits in a stationary chair.
- In cases of wheel chairs lock the brakes.



The instructions for use focus on the operating concept of the Pentacam® / Pentacam® HR. The functional description of the Pentacam program is limited to initiating a measurement and loading existing examinations.

For detailed information about the features of the Pentacam program, see the user manual.

### 9.1 Default settings

- Start the Scan menu in the Pentacam® Program:  
Menu [Examination] > [Scan]  
The blue slit light is activated and the Scan menu opens.
- If necessary make changes to the image options for the particular part of the front of the eye that is to be examined.  
The default settings in the "3D Scan" options are "25 images/ 1 second".
- Adjust the table height.
- Check that
  - fresh paper has been put onto the chin rest or
  - the chin rest has been cleaned and disinfected.
- Ask the patient to place his or her head on the chin and forehead rest.
- Do not touch the patient and the Pentacam® / Pentacam® HR simultaneously.

### 9.2 Darkening the room/dark sheet

- ➔ If the lighting in the examination room has not been turned down or switched off, use the dark sheet supplied to cover the patient and the Pentacam.

### 9.3 Rough adjustment

- ➔ Adjust the chin rest so that the patient's eyes are approximately at the level of the black ring (1) on the chin-forehead rest.

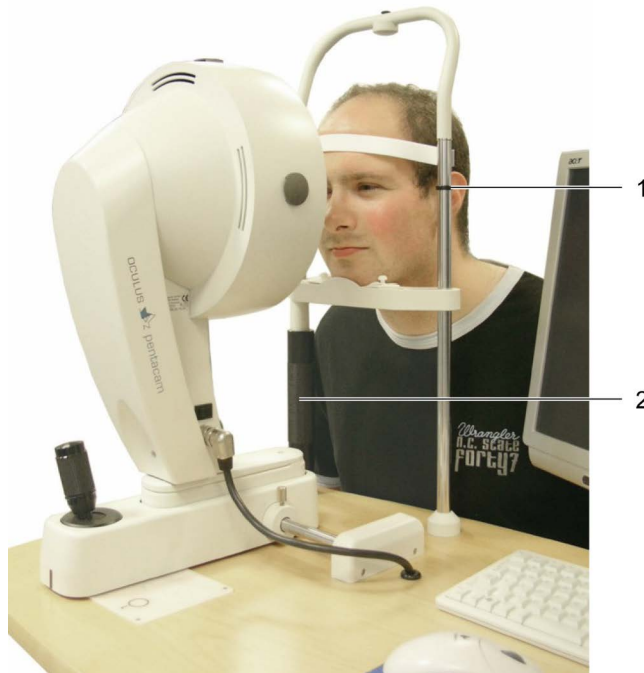

Fig. 9-1: Rough adjustment of the chin and forehead rest

No.	Description
1	Marking (black ring)
2	Twist grip

- ➔ Adjust the patient's eye level using the twist grip (2). The patient is positioned correctly when chin and forehead touch the rests and the eyes are level with the marking.
- ➔ Example of a rough adjustment for the right eye: Move the cross slide (1) until the marking at the end of the cross slide (4) roughly coincides with the circle R (3) on the sliding plate.

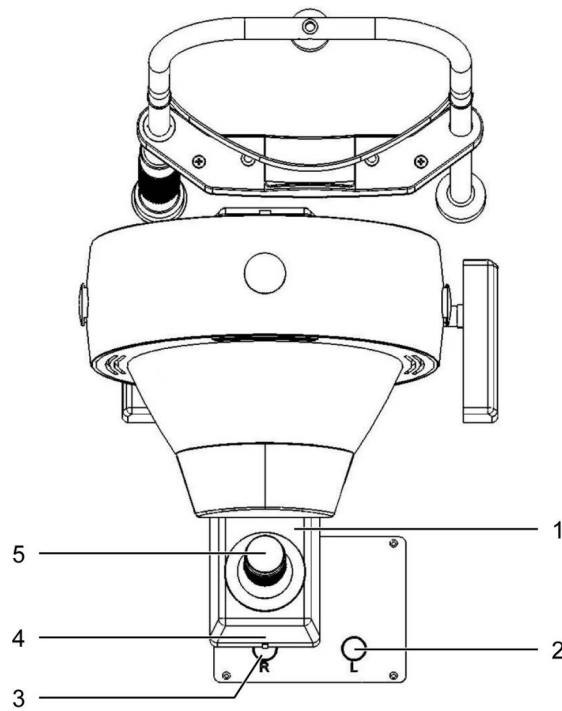

Fig. 9-2: Markings on the cross slide

No.	Description
1	Cross slide
2	Left marking
3	Right marking
4	Marking on the cross slide
5	Joystick

- ➔ Look at the patient’s eye you are examining from one side and make sure that the blue slit light illuminates the cornea.
- ➔ If necessary, adjust the position of the cross slide to the left or right.

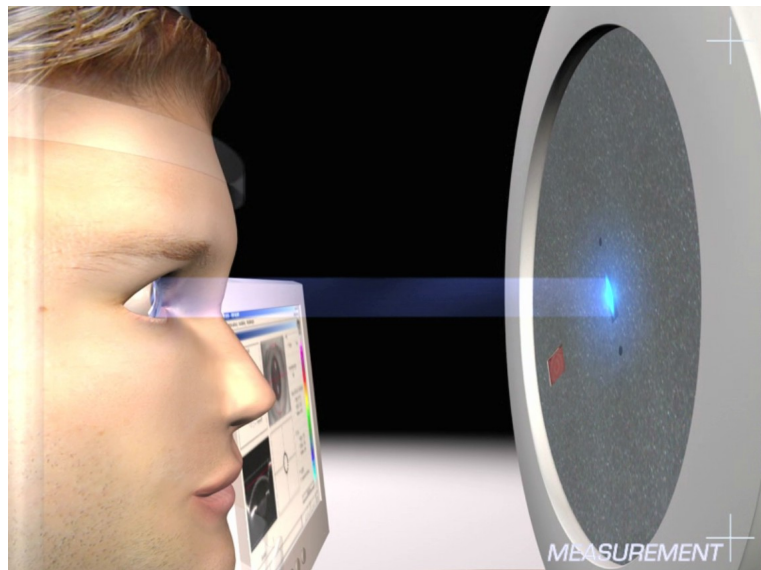

Fig. 9-3: Slit light on the cornea

**Note**

If the blue slit light is not visible, ensure that you have activated the [Slit Light] checkbox on the "Scan" screen.

- ➔ Move the cross slide towards the patient until the Scheimpflug image shows the cornea of the eye that you are examining.

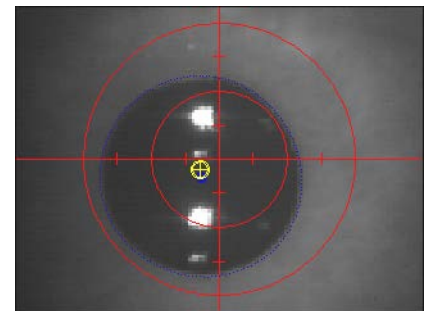
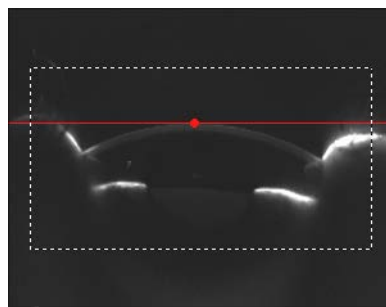

Fig. 9-4: Scheimpflug image (left) and pupil image (right)

The image is sharpest when the red dot coincides with the red line in the Scheimpflug image.

- ➔ Focus the pupil image by moving the joystick towards the Pentacam® or away from it.
- ➔ Adjust the left/right position of the Pentacam® and its height setting.

Move the joystick to the left or right and rotate the joystick clockwise or anticlockwise.

The tentative final position of the camera is reached when the yellow dot is in the centre of the crosshairs.

- ➔ Ask the patient to widen his or her eye and not to blink.

### 9.4 Fine adjustment

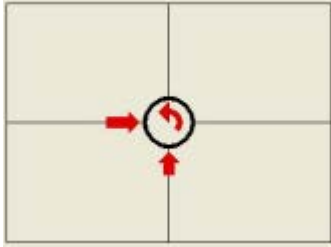

→ Make any fine adjustments required based on the information in the adjustment window. To do so, move the joystick in the specified directions.

Example:

- Move the joystick to the right.
- Turn the joystick counter clockwise.
- Move the joystick forwards.

Arrow	Camera movement	Joystick movement <sup>a</sup>
→	right	Move the joystick to the right
←	left	Move the joystick to the left
↑	forward	Move the joystick toward the patient
↓	back	Move the joystick away from the patient
↻	up	Rotate the joystick clockwise
↺	down	Rotate the joystick counter-clockwise

a.



When you have achieved the expected position, a cross will appear in the centre of the ring, surrounded by four lines. The Pentacam® will automatically begin measuring, alternately you can start the measuring procedure manually.

- For measuring manually: Start measuring by clicking [Start Scan] or by pressing the return key.



It may not be possible to carry out a measurement with manual release.

- Ask the patient to remove his or her head from the rest.
- Check the measurement results by referring to the quality specifications ([sec. 11, page 50](#)).

### 9.5 Quality Specifications

After you have begun measuring either automatically or manually, the Pentacam® program opens. The "QS" button appears in a field below the patient data.

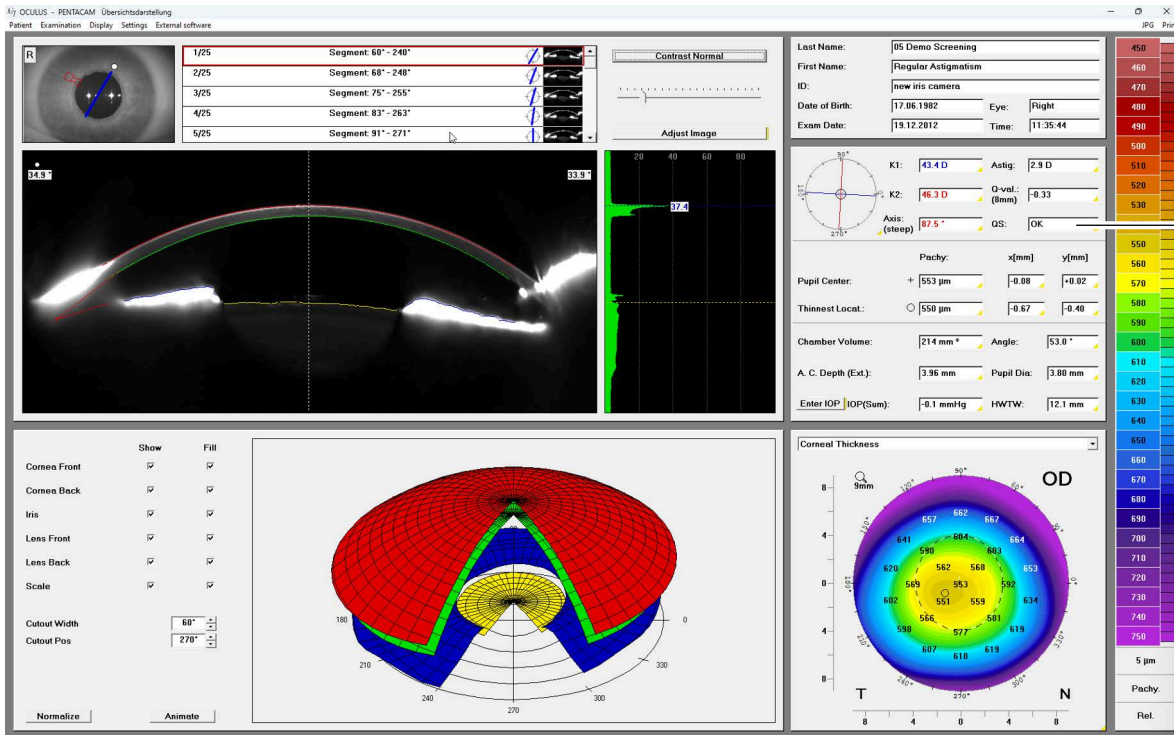

Fig. 9-5: Pentacam® program with "QS" button

No.	Description
1	"QS" button



All examinations are automatically saved, regardless of the quality of the measurement taken.

If the "QS" button

- reads OK, the measurement is correct and can be reproduced.
- is red, you must repeat the measurement.

- If the "QS" button is highlighted in yellow, then click on the button. The following dialog box appears:

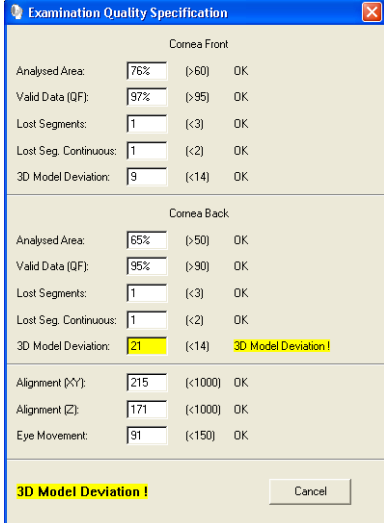

Cornea Front				
Analysed Area:	76%	(>60)	OK	
Valid Data (QF):	97%	(>95)	OK	
Lost Segments:	1	(<3)	OK	
Lost Seg. Continuous:	1	(<2)	OK	
3D Model Deviation:	9	(<14)	OK	
Cornea Back				
Analysed Area:	65%	(>50)	OK	
Valid Data (QF):	95%	(>90)	OK	
Lost Segments:	1	(<3)	OK	
Lost Seg. Continuous:	1	(<2)	OK	
3D Model Deviation:	21	(<14)	3D Model Deviation!	
Alignment (XY):	215	(<1000)	OK	
Alignment (Z):	171	(<1000)	OK	
Eye Movement:	91	(<150)	OK	

**3D Model Deviation !** Cancel

Fig. 9-6: Examination Quality Specification

- Check the measurement results.  
 → If you have any doubts, repeat the measurement.

### Notes on individual parameters

- **Analysed Area**  
If this value is less than the permissible threshold, the patient must widen his or her eye.
- **Valid Data**  
If this value is less than the permissible threshold, you must darken the room.
- **Lost Segments** and **Lost Seg. Continuous**  
If one of these values exceeds the permissible threshold, you must ask the patient not to blink while you are measuring.
- **Alignment (XY)** and **Alignment (Z)**  
If one of these values exceeds the permissible threshold, you may have moved the cross slide at the moment you began measuring.
- **Eye Movement**  
If this value exceeds the permissible threshold, it is possible that fixation of the patient is inadequate.
- **CSP Fixation**  
If this value exceeds the permissible threshold, you must repeat the measurement. If necessary explain to the patient that he has to fix the black ring.

### Terminating "QS"

- Click [Cancel] to return to the Pentacam® program.
- If required, delete the measurement if the image is inadequate.
- Terminate the current examination which has been saved.
- If required, make preparations to examine another patient. In the "Pentacam" overview, select the "Examination" menu and click [New Patient/End].

# 10 Patient Data Management

Once you have completed an examination, you can do the following with the patient data:

- Rename it (chap. "10.5 Rename Patient Data" on page 45)
- Export it (chap. "10.6 Exporting Patient Data" on page 45)
- Import it (chap. "10.7 Importing Patient Data" on page 47)
- Backup (chap. "10.8 Data Backup" on page 48)



For more information on Patient Data Management, refer to the [User Guide](#).

## 10.1 Starting Patient Data Management

After you have switched on the PC, it first loads the operating system.

➔ Press on the Pentacam® icon at the desktop.

The user interface for the Patient Data Management appears:

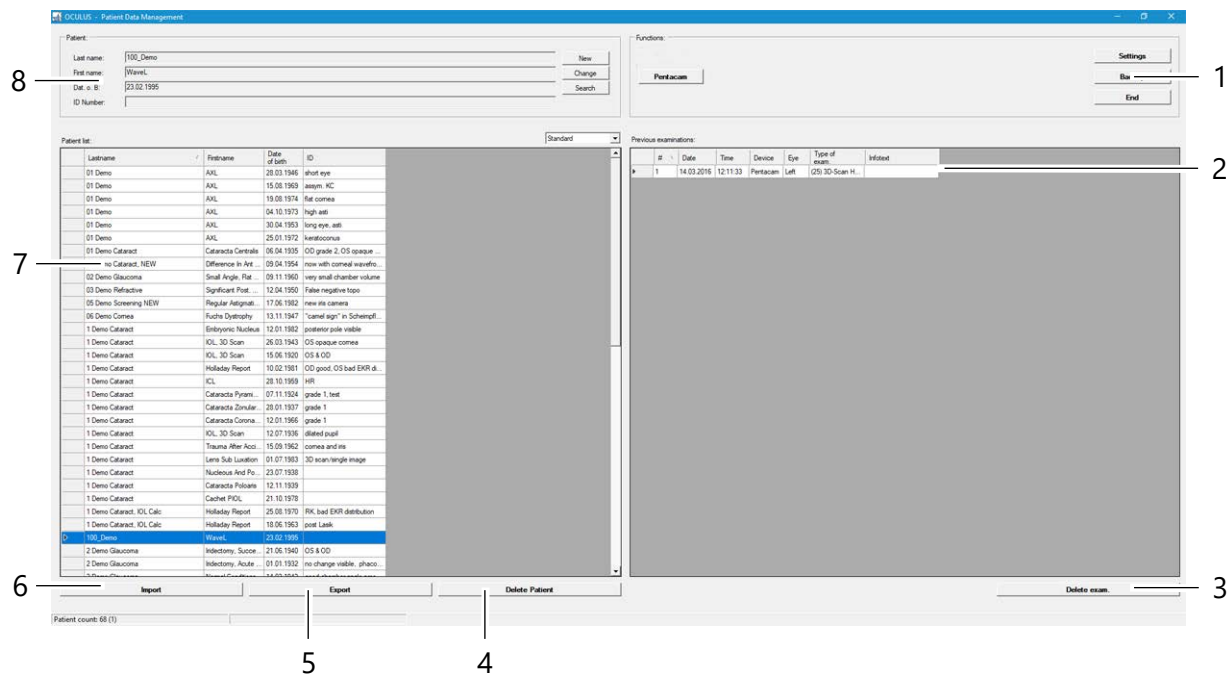

Fig. 10-1: Patient Data Management user interface

No.	Description
1	"Functions" group box
2	Previous examinations
3	[Delete exam.] button
4	[Delete Patient] button

No.	Description
5	[Export] button
6	[Import] button
7	Patient list
8	Patient data group box



To get into the Pentacam® / Pentacam® HR program, you must first enter a new patient (8) or select an existing patient from the examination list (2).

## 10.2 Entering a New Patient

- ➔ Press the [New] button to enter a new patient in the Patient Data Management system.
- ➔ Enter the patient's last name, first name and date of birth in the patient window.

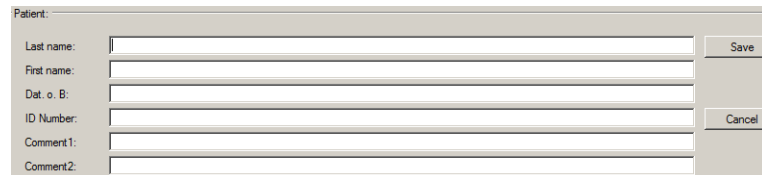
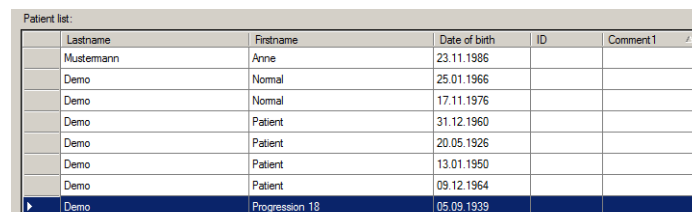

Fig. 10-2: Entering patients

- ➔ Optionally you can enter an ID number for the patient.
- ➔ To save your entries use the [Save] button.  
The patient you have just entered now appears in the patient list and is automatically selected..

## 10.3 Selecting an Existing Patient

The patient data list on the left-hand side of the screen displays all previously examined patients in alphabetical order.



Lastname	Firstname	Date of birth	ID	Comment1
Mustermann	Anne	23.11.1986		
Demo	Normal	25.01.1966		
Demo	Normal	17.11.1976		
Demo	Patient	31.12.1960		
Demo	Patient	20.05.1926		
Demo	Patient	13.01.1950		
Demo	Patient	09.12.1964		
▶ Demo	Progression 18	05.09.1939		

Fig. 10-3: Patient list

- ➔ Choose [Search] to quickly find the patient you are looking for in the list.
- ➔ Enter the patient's name or the first letter of the name in the "Last name" field.
- ➔ Alternatively, you can search for the patient using an ID number, first name or date of birth, assuming that one was assigned when the patient was first recorded.
- ➔ In the list that appears, click the entry you were searching for to transfer the patient's name to the patient window. This also brings

up a list of any previous examinations for that patient in the examination window (bottom right side).

### 10.4 Extended Patient Search: [Extended] Checkbox

➔ Click on the [Extended] checkbox.

The screen displays additional search parameters which reference previous examinations. Proceed as for the input of a patient name.

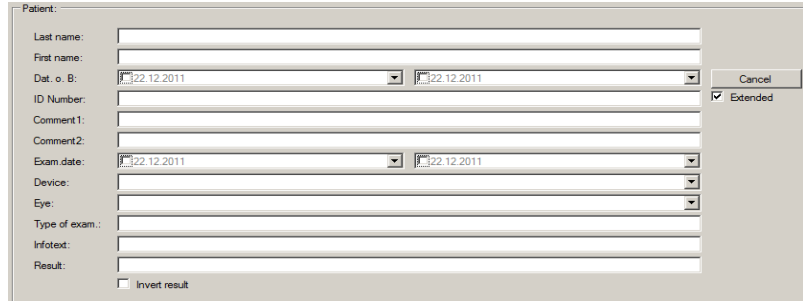

Fig. 10-4: Advanced search

### 10.5 Rename Patient Data

After creating of the patient data, you can edit it.

➔ Press the [Change] button.

The input boxes for patient data are now enabled, and the cursor jumps to the "Last name" field.

➔ Change the entries in the individual boxes.

➔ Press the [Save] button.

### 10.6 Exporting Patient Data

Patient and examination data can be exported, for example, for forwarding to another clinic.

➔ Select the patient and also one of the examinations in the respective list as required.

➔ Click [Export] button below the patient list. The following dialog appears:

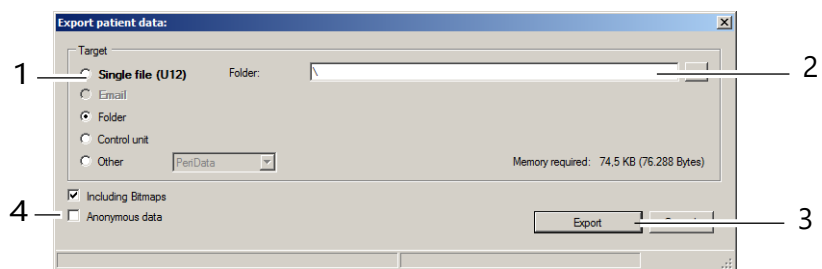

Fig. 10-5: "Export patient data" dialog

No.	Description
1	Saving destination selection
2	[...] button
3	[Cancel] and [Export] buttons
4	Options for data export



The default options for import and export of data are configured in the "Settings" field, see also the [User Guide](#). Depending on the settings, you may not have to perform all of the following steps (e.g. selection of the directory).

---

→ Select the "Target" (1) where you would like to export the data.



We recommend exporting the patient data using the "Single file (U12)" option.

- 
- Press the [...] button. (2).
  - In the dialog that appears, select the folder or the file to which the patient data should be exported.
  - Specify the name and destination of the file you are saving.
  - Make sure you have selected [Including Bitmaps].
  - Click [Export].
- The patient and examination data have now been saved at the destination specified.

You can send data stored on the hard drive as an e-mail attachment.



Requirements for transferring data to another PC:

- The Pentacam® program must be installed on the other PC. If the program is updated on the Pentacam® PC (sender), the program on the other PC (recipient) must also be updated.
  - Make sure, that the PC is connected to a local network controlled by the Floating License Key or that a single license key is connected to the PC in order to interactively evaluate the exams.
-

## 10.7 Importing Patient Data

If you receive patient data, for example, on a USB stick, you can import these data.



### Achtung

Risk of loss of data due to computer viruses  
Computer viruses can cause loss of data.

➔ Run a virus check before importing data from the USB flash drive.

➔ Press the [Import] button. The following dialog appears:

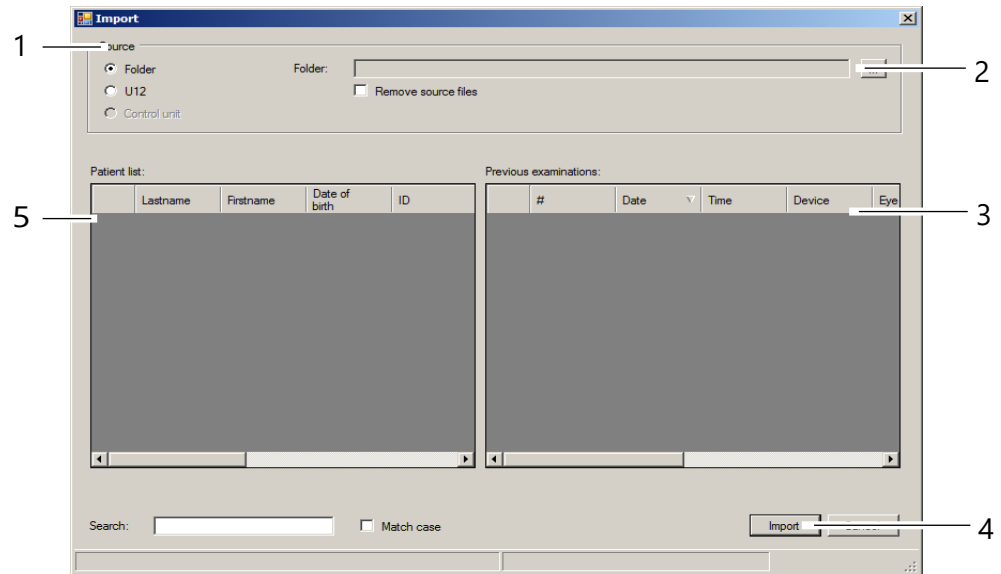

Fig. 10-6: "Import" dialog

No.	Beschreibung
1	Select data source
2	[...] button
3	Previous examinations
4	[Import] button
5	Patient list



The default options for import and export of data are configured in the "Settings" field, see also the [User Guide](#).

➔ Depending on the settings, you may not have to perform all of the following steps (e.g. selection of the directory).

➔ Select the option (1) where the source data are contained ("Folder" or "U12" (single file)).



Recommendation: Export the patient data using the "Single file (U12)" option.

- ➔ Press the [...] button. (2).
- ➔ In the dialog box, select the directory or the file where the patient data are located.
- ➔ Confirm your selection with [OK] or [Open].  
The patients and the associated examinations that are found are displayed in the lower part of the dialog.
- ➔ To import the data, press the [Import] button (4).  
The data will then be available in the Patient Data Management system.

## 10.8 Data Backup

You should make a backup copy of patient and examination data at regular intervals. In case of loss of data, you can reconstruct the data from a previously created backup with the help of this function. Since data backup takes several minutes, depending on the scope of the database and the data to be backed up, a backup should be carried out when the PC and the device will not be needed.



### Note

Risk of loss of data due to computer viruses  
Computer viruses can cause loss of data.

- ➔ Run a virus check before making a backup to an external a USB flash drive.



The general rules for security backups apply to the creation of backup copies created with the help of the Patient Data Management system. Storage of backup files should always be done on a separate system (for example an external hard drive or a USB flash drive with adequate capacity).

### 10.8.1 Backup Data

- ➔ Press the [Backup] button at the top right of the Patient Data Management system. The following dialog is displayed:

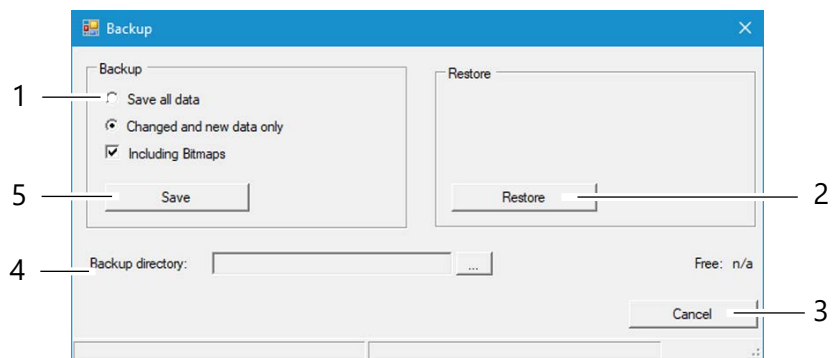

Fig. 10-7: "Backup" dialog

No.	Description
1	Backup data selection
2	[Restore] button
3	Display free storage space
4	Backup directory and button [...]
5	[Save] button

- ➔ Select whether all of the data or only changed data should be backed up.



The Patient Data Management system internally tags all saved data records.

If you select the option "Changed and new data only", only the data records that were not saved during a previous backup will be backed up.

- ➔ Press the [...] button to the right of the "Backup directory" box (4).
- ➔ In the dialog that appears, select the folder to which the data should be backed up.
- ➔ Confirm your selection with [OK].
- ➔ To back up the data, press the [Save] button (5). The previously selected data will then be backed up to the corresponding folder.

## 10.8.2 Reconstructing Data

If a loss of data occurs, the data from a previous backup can be re-imported into the Patient Data Management system.

- ➔ Press the [...] button.
- ➔ In the dialog that appears, select the folder which contains the backup data.
- ➔ Confirm your selection with [OK].
- ➔ To import the data, press the [Restore] button (2). All data in the appropriate directory are copied to the Patient Data Management system.

## 10.8.3 Automatic Backup

In addition to the manually performed backup, it is also possible to automatically run a backup when exiting the Patient Data Management system. The settings required for this can be made in the "Settings" area, see [User Guide](#).

In the patient data management you record and manage patient data.

## 11 Cleaning, Disinfection and Maintenance

Cleaning and disinfection of the Pentacam® / Pentacam® HR is described in this chapter.

Sterilization is not required.

- Heed the product descriptions and instruction manuals of products and equipment you use to care for, clean, and disinfect the unit and/or its accessories.
- Do not clean the Pentacam® / Pentacam® HR with aggressive, chlorine containing, abrasive or sharp cleaning agents.

### 11.1 Intervals for Cleaning, Disinfection and Maintenance

Interval	Activity
before each use	Place fresh paper on the chin rest or disinfect the chin rest if it is used without paper
before each use	Disinfect forehead rest
monthly	Clean device (housing, illuminated slit)
monthly	Perform test measurement
every 2 years or after 25 000 measurements	Maintenance by OCULUS Service or an authorized dealer

### 11.2 Cleaning



#### Attention

Risk of electric shock if the Pentacam® / Pentacam® HR is not completely disconnected from the mains for these jobs.

- Turn the Pentacam® / Pentacam® HR off, [sec. 7.5, page 27](#).
- Pull the power plug before cleaning. When disconnecting electrical connections, pull on the respective plug and not on the cable itself.

Required materials:

- Antistatic cleaning agent
- Cleaner for painted surfaces: Mixture of equal parts of alcohol and distilled water, possibly with a few drops of household detergent
- Soft, lint-free cloth
- Purified compressed air

#### 11.2.1 Cleaning the Housing

- It is best to clean the housing surfaces with a soft cloth and an anti-static cleaning agent.

- Wipe off any residue from painted surfaces with the mixture for painted surfaces.

### 11.2.2 Cleaning the Chin-Forehead Rest

- Make sure that no liquid gets into any of the openings of the Pentacam® / Pentacam® HR.  
Do not use liquid from aerosol cans.
- Clean the chin-forehead rest with a soap solution (or with alcohol, if very dirty).
- Use a lint-free, damp cloth.

### 11.2.3 Cleaning the illuminated slit

The optical components illuminating the slit, and the lens in front of the camera are precision parts and sensitive to pressure. The surfaces of these components are susceptible to scratching.



#### Attention

Damage to the optics due to improper cleaning

- When cleaning the illuminated slit, do not use a cloth or cleaning agents.

- Carefully clean the centre of the illuminated slit with purified compressed air.
- Clean the lens in front of the camera using a dry, lint-free cloth.

## 11.3 Disinfection

- We recommend using disinfection wipes suitable for medical devices, for example:  
Mikrozid sensitive wipes premium  
Fa. Schülke & Mayr GmbH  
Softpack 48 pcs. / Art. No. 165711  
Tel: +4940521000; Fax: +494052100318  
E-Mail@schuelke.com  
www.schuelke.com



#### Attention

Equipment damage caused by disinfectant solution

The disinfectant solution may damage the surface of the device if it is sprayed directly on it.

- Spray the disinfectant solution onto a cleaning cloth, do not spray it directly on the device.

- Disinfect the forehead rest after each examination.
- If you do not use paper for the chinrest, disinfect the chinrest after each examination.

### 11.4 Test measurements

The Pentacam® / Pentacam® HR is tested and calibrated in the Oculus factory.

OCULUS Optikgeraete GmbH recommends to perform regular test measurements of the Pentacam® / Pentacam® HR.

A human eye should be measured initially. Minimum 5 consecutive measurements per eye should be done and the arithmetic mean has to be calculated and recorded.

**Once in a month this measurement should be repeated using this eye as described above.**

The arithmetic mean of the initial and the current measurement should be compared.

The tolerance range of the original and the current results are described in the table chart below.

		Tolerance Range
Tomography	Basic	+/- 0.2 dpt
	HR	+/- 0.1 dpt
Pachymetry		+/- 10 µm

If the difference between the initial and the current measurement is outside the tolerance range, please inform us or contact your authorized Oculus distributor to get further support.

### 11.5 Maintenance

In order to retain the high measurement accuracy of the Pentacam® / Pentacam® HR OCULUS Optikgeräte GmbH recommends to perform a maintenance service every two years or after 25000 scans. A corresponding message appears.

By daily pop up window:

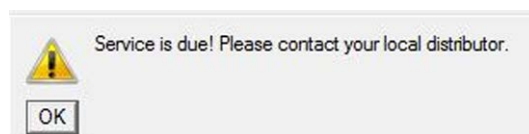

Fig. 11-1: Daily pop up window

In the settings, *see User Guide*:



Fig. 11-2: Date of next service and number of performed examinations

In the scan menu, *sec. , page 32*:



Fig. 11-3: Preliminary information (3 month before)

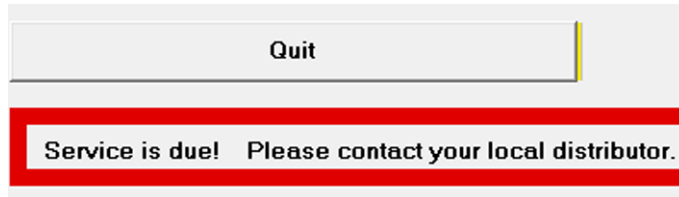

Fig. 11-4: Information when service is due

In examinations (it will be stored):



Fig. 11-5: Sign to perform maintenance

Let the Pentacam® / Pentacam® HR checked by our service department or an authorized dealer.

## 11.6 Attaching Paper to the Chin Rest

If you want to attach new chin rest paper, follow these instructions:

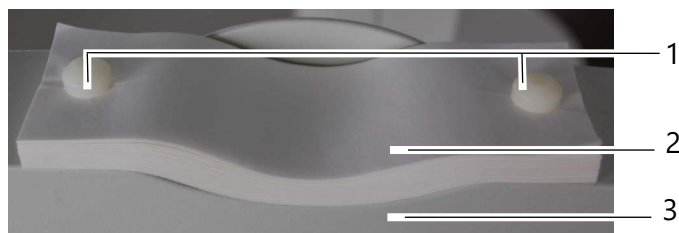

Fig. 11-6: Fasten chin rest paper

Nr.	Beschreibung
1	Pins
2	Paper for chin support
3	Chin rest

- ➔ Pull the two pins (1) out of the chin rest.
- ➔ Place the chin rest paper (2) in such a way that the holes of the paper and those in the chin rest (3) are aligned.

→ Insert the two pins (1) in the chin rest.

## 12 Troubleshooting



### Caution

Personal injury or damage to equipment due to incorrect troubleshooting

- ➔ If an error occurs which you are unable to correct by following the instructions below, label the device as "out of order" and contact our service department or an authorised dealer.

Errors	Possible cause	Solution
After you have started the Pentacam® program, the following dialog box appears: "No communication with Pentacam!".	Power supply without voltage	<ul style="list-style-type: none"> <li>■ Check whether the indicator light on the power supply is on. If not, connect the power supply to the mains.</li> </ul>
	Power cord of the Pentacam® / Pentacam® HR not plugged in properly	Check whether <ul style="list-style-type: none"> <li>■ the power supply cable is correctly attached to the Pentacam® / Pentacam® HR.</li> <li>■ the blue slit light is visible in the Scan menu (<a href="#">sec. , page 32</a>).</li> <li>■ the USB connector is properly inserted.</li> </ul>
	Software/hardware problems	<ul style="list-style-type: none"> <li>■ Switch the Pentacam® off and restart the PC. Switch the Pentacam® on as soon as Patient Data Management becomes active. When you start the Pentacam® program, the message, "Load Bootloader" must appear.</li> <li>■ Contact the service department or your authorised dealer</li> </ul>

## 13 Transport and Storage

The Pentacam® / Pentacam® HR, must be properly dismantled and packed before being transported or stored.



### Caution

Risk of equipment damage due to incorrect shipment or from improper storage

- ➔ Avoid shocks, vibrations, and contamination.
- ➔ Avoid high temperatures and humidity.

- Transport the Pentacam® / Pentacam® HR carefully.
- Do not hold the device by the joystick to carry it.
- Store the Pentacam® / Pentacam® HR in compliance with the storage conditions.
- Avoid placing near heaters and moisture.

### 13.1 Storage conditions

Ambient temperature range	-10°C to +55°C
Relative humidity, including condensation	10% to 95%
Air pressure range	700 hPa to 1060 hPa

### 13.2 Transport conditions

Ambient temperature range	-40°C to +70°C
Relative humidity, including condensation	10% to 95%
Air pressure range	500 hPa to 1060 hPa

### 13.3 Disassembly

- ➔ End the current session.
- ➔ Switch off the device.
- ➔ Disconnect the cable from the computer/laptop and the power adapter.



Fig. 13-1: Disassembly

- ➔ Loosen the screw connection of the Y cable and pull it out. When disconnecting electrical connections, pull on the respective plug and not on the cable itself.

## 14 Disposal

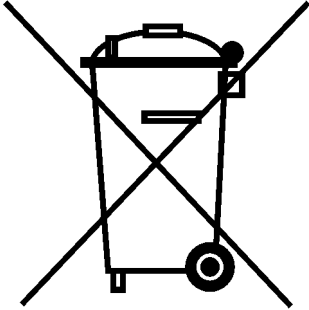

In accordance with Directive 2012/19/EC of the European Parliament and the Council and, in accordance with German law governing the marketing, return and environmentally compatible disposal of used electrical and electronic devices, such appliances must be recycled and may not be discarded as household waste.

→ Dispose the Pentacam® / Pentacam® HR in a compliant manner.

## 15 Terms of Warranty and Servicing

### 15.1 Terms of Warranty

Please note the following warranty provisions:

- Prior to and while operating the device it is important that you heed the instruction manual and safety instructions.
- In accordance with legal regulations, you are entitled to a warranty for the Pentacam® / Pentacam® HR.
- If modifications are made to the Pentacam® / Pentacam® HR by unauthorized persons, all warranty claims shall be voided. Improper modifications and repairs may result in considerable hazards to users and patients.
- Any entitlement to a warranty shall also be void if unauthorized persons interfere with the supplied computer hardware and software.
- Any transport damage must be reported immediately to the shipping company. Have the transport damage noted on the bill of lading so that complaint handling and compensation of damages can proceed in an orderly manner.
- In general, our Business and Shipping Terms on the date of purchase apply.

### 15.2 Assumption of Liability for Functions and Damage

OCULUS will only accept responsibility for the safety, reliability and serviceability of the Pentacam® / Pentacam® HR if the unit is used in compliance with the following terms:

- Only use the equipment in conformance with this instruction manual.
- There are no parts either on or inside the Pentacam® / Pentacam® HR that require maintenance or repair by the user. If assembly work, modifications, adjustments, repairs, changes or service are performed by unauthorized personnel, or if the Pentacam® / Pentacam® HR is improperly maintained or handled, then any liability by OCULUS is voided.
- If the above-referenced work is performed by authorized persons, request a certification of the scope and type of repair, and, if necessary, the changes to the standard values or to the operating range from the service technician. This certification must contain the date of performance and statement of the performing firm, with signature.
- If requested, OCULUS will provide the service technician with a list of spare parts and additional descriptive material for this purpose.
- Make certain that only original OCULUS parts are used.

## 16 Technical Data

### Measuring equipment

	Pentacam®	Pentacam® HR
Camera	Digital CCD camera	Digital CCD camera
Light source	Blue LED (475 nm, UV-free)	Blue LED (475 nm, UV-free)
Processor	DSP with 400 Mio. operationen/s	DSP with 400 Mio. op- erationen/s
Speed	50 images in 2 seconds <sup>a</sup>	100 images in 2 seconds <sup>b</sup>
Number of evalu- ated measuring points	max. 25.000	max. 138.000
Dimensions (W x D x H)	275 x 320 to 400 x 500 to 530 mm (10.8 x 12.6 to 15.7 x 19.7 to 20.9 in)	275 x 320 to 400 x 500 to 530 mm (10.8 x 12.6 to 15.7 x 19.7 to 20.9 in)
Weight	7,2kg <sup>c</sup> (15.9 lbs)	7,8 kg <sup>c</sup> (17.2 lbs)

a. Scheimpflug image of the entire anterior segment

b. Cornea fine scan

c. Weight without base

### Measuring range

	Pentacam®	Pentacam® HR
Corneal topographer according ISO 19980	Type A	Type A
Curvature	3 – 38 mm 9 – 99 D	3 – 38 mm 9 – 99 D
Accuracy	± 0.2 D	± 0.1 D
Reproducibility	± 0.2 D	± 0.1 D
Working distance	80 mm (3.1 in)	80 mm (3.1 in)

### Power adapter

Power adapter	HEMG49-S240210-7 (05150150)
Mains connection	100 – 240 V AC
Frequency	50/60 Hz
Power input, max.	85 VA
Output voltage	24 V DC
Fuses	Integrated overcurrent shut-off

### Power supply

Output voltage	24 V DC
Electric consumption during operation with Pentacam®	35 W
Pentacam® HR	42 W

### Life expectancy

Lifecycle expectancy	up to 10 years
----------------------	----------------

### Classification according to IEC 60601 - 1

Type of protection against electrical shock	Protection class 2
Insulation of applied parts	Type B

### Computer

The IT equipment (computer, monitor etc.) must comply with the requirements of IEC 62368-1.

Recommended computer specifications	Intel® Core™ i5, 500 GB SSD, 8 GB RAM, Windows® 11, Intel® HD Graphics
Recommended screen size	24"
Recommended screen resolution	1920 x 1080 Pixel (Full HD)

### CE in accordance with Regulation (EU) 2017/745 on Medical Devices (MDR)

The unit is a class IIa product.



Conformity assessment procedure: (EU) 2017/745 MDR, Annex IX, chapter I and III.

## 17 Annex

### 17.1 Electromagnetic Compatibility

Medical electrical equipment is subject to special precautionary requirements with respect to EMC, and must be installed and operated according to the EMC-Instructions contained in the accompanying paperwork.

OCULUS devices and systems are suitable for use in professional healthcare establishments, e.g. doctor's practices or clinics; however, they may not be used in proximity to HF surgical units or inside of the HF shielded room of an ME system for magnetic resonance imaging. Portable and mobile HF communications appliances can affect medical, electric equipment.

No special measures need be observed in respect of OCULUS devices and systems.



#### Attention

**Portable and mobile RF-communications devices can interfere with electrically operated medical devices and affect the performance of the device.**

The device is intended for use in an electromagnetic environment in which the radiated RF interference is uncontrolled. The user can help prevent electromagnetic interference by maintaining the following minimum distance, based on the maximum output of the communication equipment, between portable and mobile RF communication devices (transmitters) and the device:

- ➔ Portable RF communication devices (including peripheral devices such as antenna cables and external antennas) should not be any closer than 30 cm (12 inches) to any part of the device.

#### Minimal performance quality and essential performance criteria

- A slightly disturbance of the analog camera of the Pentacam® / Pentacam® HR (slightly image noise on screen) during the examination is permissible because it will not affect the diagnosis, treatment and observation.
- A short flicker of the illumination of the Pentacam® / Pentacam® HR during the examination is permissible because it will not affect the diagnosis, treatment and observation.
- A short interruption of the USB connection during the examination is permissible because it will not affect the diagnosis, treatment and observation.



#### Caution

The use of accessories, transducers and cables specified by OCULUS with devices other than the Pentacam® / Pentacam® HR may result in increased emissions or decreased immunity of the other device.

- ➔ Do not use the accessories, transducers and cables specified by OCULUS with devices other than the Pentacam® / Pentacam® HR.
- ➔ Use only the original accessories, transducers and cables specified by OCULUS.

To be in compliance with the requirements of the IEC 60601-1-2 the following types of equipment, accessories, power adapters and cables must be used.

Order number	Description	
70700	Pentacam®	
70900	Pentacam® HR	
05200320	Cable with connector plug, EU standard	2.5 m (98.4 in)
05200210 (110 Volt)	Cable with connector plug, US standard	2.5 m (98.4 in)
05150150	Power adapter HEMG49-S240210-7	24 V, 2,1A
017090000052	Y cable with galvanic isolation	2 m

## 17.2 Guidance and Manufacturer's Declaration - Electromagnetic Emissions and Immunity

### Guidance and manufacturer's declaration electromagnetic emissions IEC 60601-1-2

The OCULUS Pentacam® / Pentacam® HR is intended for operation in the electromagnetic environment specified below. The user of the Pentacam® / Pentacam® HR should ensure that it is being used in such an environment.

Emissions test	Compliance	Electromagnetic environment - guidance
RF emissions CISPR 11	Group 1	The Pentacam® / Pentacam® HR uses RF energy only for its internal function. Therefore, its RF emissions are very low and are not likely to cause any interference in nearby electronic equipment.
HF-emissions CISPR 11	Class B	
Harmonics emissions IEC 61000-3-2	Class A	
Voltage fluctuations / flicker emissions IEC 61000-3-3	complies	

Electromagnetic immunity, IEC 60601-1-2			
Immunity test	IEC 60601 test level	Compliance level	Electromagnetic environment - guidance
Electrostatic discharge (ESD) IEC 61000-4-2	± 8 kV contact ± 15 kV air	± 8 kV ± 15 kV	Floors should be made of wood or concrete or covered with ceramic tiles. If the floor is covered with synthetic material, the relative humidity must be at least 30%.
Power frequency (50/60Hz) magnetic field IEC 61000-4-8	30 A/m 50 Hz or 60 Hz	30 A/m 50 Hz or 60 Hz	Power frequency magnetic fields should be at levels characteristic of a typical location in a typical commercial or hospital environment.
Electrical Fast transient/bursts IEC 61000-4-4	± 2 kV for power supply lines 100 kHz repetition frequency ± 1 kV for input/output lines	± 2 kV ----- ± 1 kV	Mains power quality should be that of a typical commercial or hospital environment.
Surge IEC 61000-4-5	± 1 kV line(s) to line(s) ± 2 kV line(s) to earth	± 1 kV differential mode ± 2 kV line(s) to earth	Mains power quality should be that of a typical commercial or hospital environment.
Voltage dips, short interruptions, and voltage variations on power supply input lines IEC 61000-4-11	0% $U_T$ : 1/2 period at 0, 45, 90, 135, 180, 225, 270 and 315 degree  0% $U_T$ : 1 period and 70% $U_T$ : 25/30 periods Single-phase: at 0 degree  0% $U_T$ : 250/300 periods	0% $U_T$ : 1/2 period at 0, 45, 90, 135, 180, 225, 270 and 315 degree  0% $U_T$ : 1 period and 70% $U_T$ : 25/30 periods Single-phase: at 0 degree  0% $U_T$ : 250/300 periods	Mains power quality should be that of a typical commercial or hospital environment. If the user of the Pentacam® / Pentacam® HR requires continued operation during power mains interruptions, it is recommended that the Pentacam® / Pentacam® HR be powered from an uninterruptible power supply or battery.
Note: $U_T$ is the a.c. mains voltage prior to application of the test level.			

Electromagnetic immunity, IEC 60601-1-2			
Immunity test	IEC 60601 test level	Compliance level	Electromagnetic environment - Guidelines
Conducted RF IEC 61000-4-6	$3 V_{\text{eff}}$ 150 KHz to 80 MHz 6 V in ISM- and amateur radio frequency bands between 150 kHz and 80 MHz 80% AM to 1 kHz	$V_{\text{eff}} = 3 \text{ V}$	Portable and mobile RF communications equipment should be used no closer to any part of Pentacam® / Pentacam® HR, including cables, than the recommended separation distance calculated from the equation applicable to the frequency of the transmitter. Recommended separation distance $d = \left[ \frac{3,5}{(V_1)} \right] \sqrt{P}$ $d = \left[ \frac{3,5}{(E_1)} \right] \sqrt{P} \quad 80\text{MHz to } 800 \text{ MHz}$ $d = \left[ \frac{7}{(E_1)} \right] \sqrt{P} \quad 800 \text{ MHz to } 2.5 \text{ GHz}$
Radiated RF IEC 61000-4-3	$3 \text{ V/m}$ 80 MHz to 2,7 GHz 80% AM at 1 kHz		where P is the maximum output power rating of the transmitter in watts (W) according to the transmitter manufacturer and d is the recommended separation distance in metres (m). Field strength from fixed RF transmitters, as determined by an electromagnetic site survey (a), should be less than the compliance level in each frequency range (b). Interferences may occur in the vicinity of equipment marked with the following symbol: 
Note 1: Note 2:	At 80 Hz and 800 MHz, the higher frequency range applies. These guidelines may not apply in all situations. Electromagnetic propagation is affected by absorption and reflection from structures, objects and people.		
a. Field strengths from fixed transmitters, such as base stations for radio (cellular/cordless) telephones and land mobile radios, amateur radios, AM and FM radio broadcast, and TV broadcast cannot be predicted theoretically with accuracy. To assess the electromagnetic environment due to fixed RF transmitters, an electromagnetic site survey should be considered. If the measured field strength in the location in which the Pentacam® / Pentacam® HR is used exceeds the applicable RF compliance level above, the Pentacam® / Pentacam® HR should be observed to verify normal operation. If abnormal performance is observed, additional measures may be necessary, such as re-orienting or relocating the Pentacam® / Pentacam® HR. b. Over the frequency range 150 KHz to 80 MHz, field strengths should be less than 3 V/m.			

**Recommended separation distances between portable and mobile RF communications equipment and the Pentacam® / Pentacam® HR, IEC 60601-1-2**

The Pentacam® / Pentacam® HR is intended for use in an electromagnetic environment in which radiated RF disturbances are controlled. The customer or the user of the Pentacam® / Pentacam® HR can help prevent electromagnetic interference by maintaining a minimum distance between portable and mobile RF communications equipment (transmitters) and the Pentacam® / Pentacam® HR as recommended below, according to the maximum output power of the communications equipment.

Rated maximum output power of transmitter W	Separation distance according to frequency of transmitter m		
	150 KHz to 80 Mhz $d = 1.2 \sqrt{P}$	80 MHz to 800 MHz $d = 1.2 \sqrt{P}$	800 MHz to 2.5 GHz $d = 2.3 \sqrt{P}$
0.01	0.12	0.12	0.23
0.1	0.38	0.38	0.73
1	1.2	1.2	2.3
10	3.80	3.80	7.3
100	12	12	23

For transmitters rated at a maximum output power not listed above, the recommended separation distance  $d$  in metres (m) can be estimated using the equation applicable to the frequency of the transmitter, where  $P$  is the maximum output power rating of the transmitter in watts (W) according to the transmitter manufacturer.

NOTE 1: At 80 MHz and 800 MHz, the separation distance for the higher frequency range applies.

NOTE 2: These guidelines may not apply in all situations. Electromagnetic propagation is affected by absorption and reflection from structures, objects and people.

### 17.3 Description of the Connection

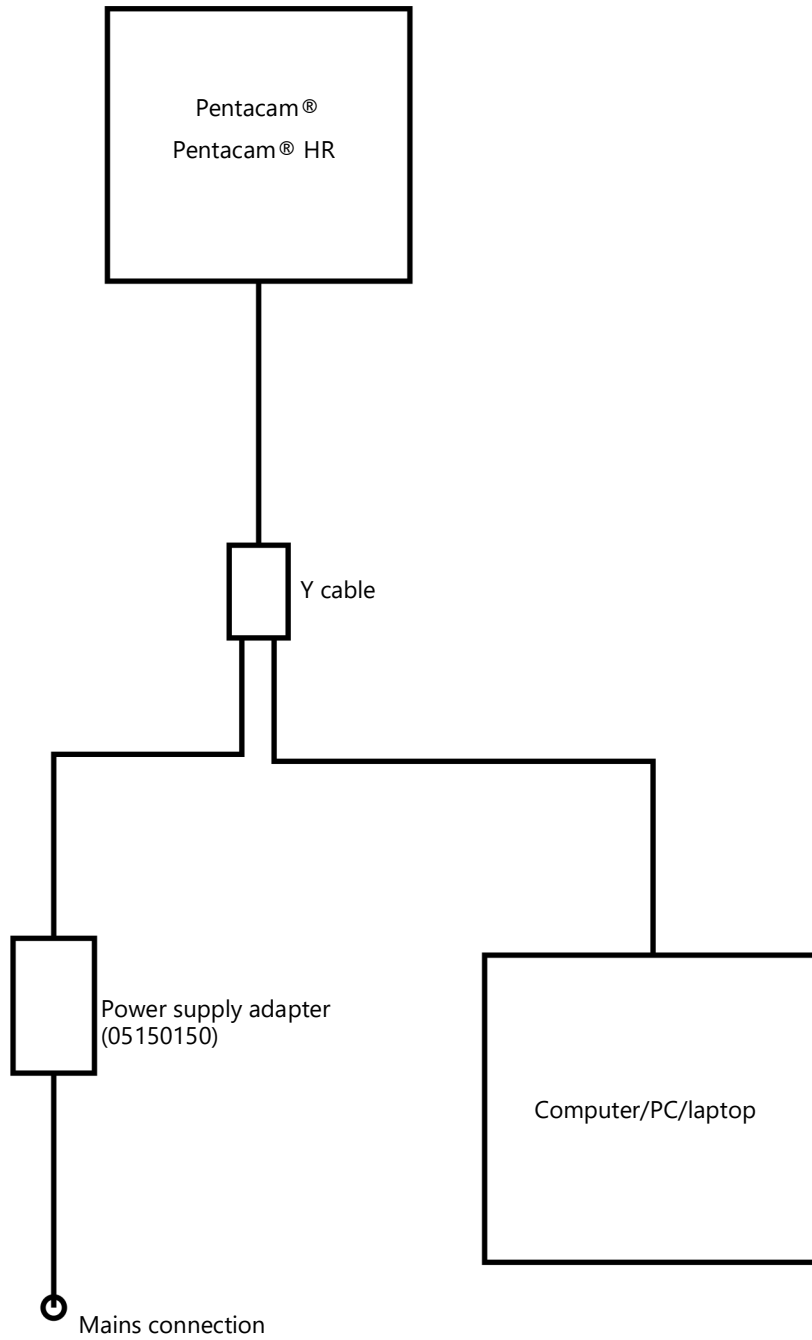

17.4 Data sheet HEMG 49-S240210-7 (05150150)

# HiTRON

**UNIVERSAL INPUT AC-DC MEDICAL & ITE APPLICATION  
EXTERNAL DESKTOP SWITCHING ADAPTER 48-50 WATTS  
GREEN POWER SINGLE OUTPUT HEMG49 SERIES**



**FEATURES:**

- ACCOMMODATE UNIVERSAL AC INPUT
- MEET MEDICAL STANDARDS IEC60601-1 & ITE STANDARDS IEC60950-1
- EMI MEET EN 55011 & EN55022 / FCC CLASS B
- MEET ENERGY STAR LEVEL V & CEC LEVEL IV
- CE MARKING COMPLIANCE

**SPECIFICATION**

**INPUT SPECIFICATION**

**Input Voltage:** Typical 90-264Vac.  
**Input Connector:** 3 pole AC inlet IEC320-C14(DT7) / 2 pole AC inlet IEC320-C8(DT8).  
**Input Frequency:** 47-63Hz.  
**Inrush Current:** 12Arms (52Apk) at 230Vac.  
**Input Current:** Typical 0.91A at 115Vac/ 0.57A at 230Vac.  
**Dielectric Withstand:** Meet IEC60601-1 & IEC60950-1.  
**EMI:** Meet EN55011 & EN55022 / FCC Class B.  
**Hold-up Time:** Typical 12mS at 115Vac. Typical 70mS at 230Vac.  
**Over Temp. Protection:** Optional (NTC circuit).  
**Earth Leakage Current (Class I) :** Less than 0.3 mA.  
**Touch Leakage Current (Class I & II) :** Less than 0.1mA.  
**No Load Power:** Less than 0.3W at 230Vac

**OUTPUT SPECIFICATION**

**Output Voltage:** See Ratings Chart.  
**Output Current:** See Ratings Chart.  
**Output Wattage:** Typical 48-50Watts.  
**Output Connector & Cord:** Optional.  
**Line Regulation:** Typical 0.1%.  
**Load Regulation:** Typical ±1.5-3.0%.  
**Noise & Ripple:** 1.0% peak to peak.  
**OVP:** Built-in by latch circuit.  
**Adjustability:** Factory set.  
**Over Current Protection (OCP):**  
 Fully protected against output overload and short circuit.  
 The PSU will shut down after OCP is activated.  
 Consult the factory for OCP setting.

**GENERAL SPECIFICATION**

**Efficiency:** Typical 87%-88% (various with the output voltage)  
**Switching Frequency:** Typical 65KHz.  
**Circuit Topology:** Fixed Frequency Flyback circuit.  
**Transient Response:** Output voltage returns in less than 5.5mS following a 50% load change.  
**Safety Standard:** Meet Medical IEC60601-1 & ITE IEC60950-1, Class I for DT7(C14) or Class II for DT8(C8)  
**Operating Temperature:** 0°C to +40°C.  
**Storage Temperature:** -20 to +85°C.  
**Cooling:** Free air convection.  
**Construction:** Impact resistant thermo-plastic enclosure case.  
**Power Density:** 3.14-3.27Watts. / Cubic inch.  
**Desktop Format.**

NOTE: (1) All measurements are at nominal input, full load, and +25°C unless otherwise specified.  
 (2) Load regulation is measured at 115Vac or 230Vac in percentage to indicate the change in output voltage as the load varied from half load to full load (±%).  
 (3) The exact obtainable load regulation depends upon the output cord selected and load current.  
 (4) Due to requests in market and advances in technology, specifications subject to change without notice.



For the details of safety approval, please consult the factory.

## OUTPUT VOLTAGE / CURRENT RATINGS CHART

### SINGLE OUTPUT

MODEL NO.	AC INLET	O/P VOLTAGE	O/P CURRENT
HEMG49-S120400-7	IEC320-C14(DT7)	12.0Vdc	4.0A
HEMG49-S120400-8	IEC320-C8(DT8)	12.0Vdc	4.0A
HEMG49-S150330-7	IEC320-C14(DT7)	15.0Vdc	3.3A
HEMG49-S150330-8	IEC320-C8(DT8)	15.0Vdc	3.3A
HEMG49-S240210-7	IEC320-C14(DT7)	24.0Vdc	2.1A
HEMG49-S240210-8	IEC320-C8(DT8)	24.0Vdc	2.1A

**MECHANICAL DIMENSIONS: MM [INCHES]**

**WEIGHT: 373.0g (13.2 Oz.)**

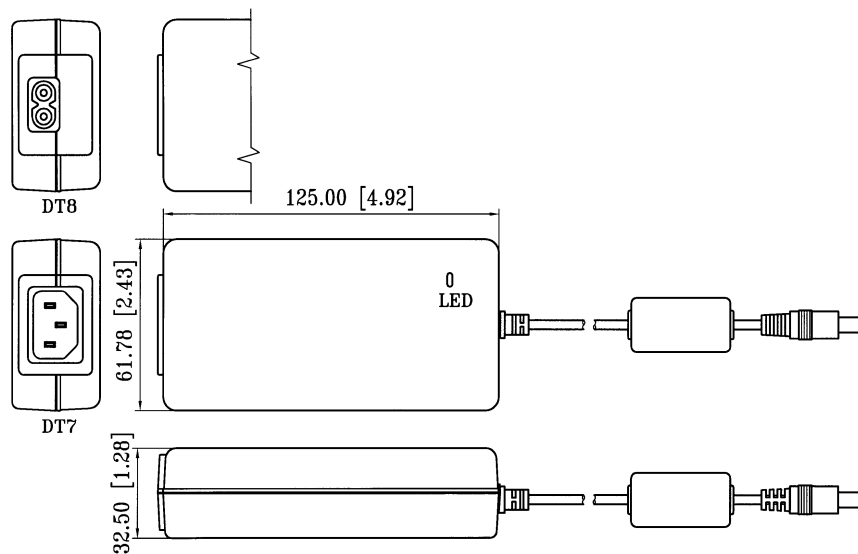

## 17.5 Instructions for integration into an IT-Network

The device, in conjunction with the connected computer and the device software running on it, forms a programmable electrical medical system (PEMS) according to IEC 60601-1.

It is essential that you follow the chap. "4.12 Instructions on Cyber Security" on page 17 of "Safety Instructions" (page 12) in the device instruction manual.

Please note the following information for implementing an integration of the PEMS into an IT-Network:

### **The purpose of integrating the PEMS into an IT-Network can be:**

- Licensing by local license server
- Storage and retrieval of the examination data on a local network drive
- Printing
- Data export
- DICOM workflow

### **Required characteristics of the IT-Network into which the PEMS is to be integrated:**

- Prefer wired LAN connection
- IPv4 network
- Fast-Ethernet (100 Mbit/s minimum)

### **Required configuration of the IT-Network into which the PEMS is to be integrated:**

- Licensing: required opened ports: 3968 TCP; 51371 - 51372 UDP
- Storage, printing, data export: File and Printer Sharing for Microsoft Networks (SMB 3.0 or higher - required opened port: 445]
- DICOM Storage Service Class = PACS
- DICOM Worklist Management Service Class (Modality Worklist Server)

### **Technical specifications of the network connection with the PEMS, including the specifications of data security:**

- Refer to the „Instructions on Cyber Security“ section (chap. "4.12 Instructions on Cyber Security" on page 17).
- Refer to the "Floating License Key - License management for software options" instruction manual (if applicable)
- Refer to device specific DICOM interface description (if applicable)

### **The intended flow of information between PEMS, the IT-Network and other devices in the IT-Network and the intended routing through the IT-Network**

- License handling from local license server to PEMS and vice versa
- Storage and data export to local network storage and loading from local network storage
- Printout to local printer

**List of hazard situations that result from the IT-Network being unable to provide the features that are required to fulfill the purpose of integrating the PEMS into to meet the IT-Network:**

- Loss of data
- unsuitable data exchange
- Data corruption
- unsuitable temporal data allocation
- unexpected data reception
- unauthorized access to data



Connection of the PEMS to an IT-Network that includes other equipment could result in previously unidentified risks to patients, operators or third parties.

The responsible organization should identify, analyze, evaluate and control these risks.

Subsequent changes to the IT-Network could introduce new risks and require additional analysis.

**Changes to the IT-Network include:**

- changes in IT-Network configuration
  - connection of additional items to the IT-Network
  - disconnecting items from the IT-Network
  - update of equipment connected to the IT-Network
-

WWW.OCULUS.DE

**OCULUS Optikgeräte GmbH**

Postfach • 35549 Wetzlar • GERMANY

Phone +49 641 2005-0 • Fax +49 641 2005-255

E-mail: sales@oculus.de • www.oculus.de

10028075  
Lot:

