

OCULUS | BIOM[®] 5



INSTRUCTION MANUAL
Binocular Indirect Ophthalmomicroscope

Foreword

The BIOM® 5 has been manufactured and tested according to strict quality criteria. To ensure safe operation, it is essential that you use the device correctly. For this reason, you should thoroughly familiarize yourself with the contents of this instruction manual before operating the device. In particular, pay attention to the safety instructions.

This operating manual describes the following BIOM® 5 models:

- BIOM® 5c and 5cl (long version)
- BIOM® 5m and 5ml (long version)

Except for the difference in length, the respective long version is identical with respect to handling and features.

The long versions should be used at microscope focal lengths of $f = 200 \text{ mm}$

Due to ongoing development, the diagrams shown in the instruction manual may depict minor changes to the actual device delivered.

If you have any questions or would like additional information about your device, please do not hesitate to contact us by mail or fax. Our service team will gladly assist.

OCULUS Optikgeräte GmbH

Article number: G/55400/EN

Revision: 04

Release: 15.10.2024

Table of Contents

1	Scope of Delivery.....	5
2	BIOM® 5 Symbols	6
2.1	On the device/nameplate.....	6
2.2	On the packaging.....	7
3	Structure of the Documentation.....	8
4	Safety Instructions.....	9
4.1	Pictograms in this manual.....	9
4.2	Safety Instructions for Use.....	9
4.3	Instructions for operating personnel.....	10
4.4	Transport and storage instructions	10
4.5	Instructions for setup and connection	10
4.6	Operation and maintenance information	10
4.7	Instructions for Use.....	11
4.8	Troubleshooting.....	11
4.9	Instructions for disassembly and disposal.....	11
4.10	EMC and electrical safety information	11
5	Purpose.....	12
5.1	Intended medical indication	12
5.2	Contraindication	12
5.3	Possible side effects	12
5.4	Intended users.....	12
5.5	Patient group	12
6	Device Description	13
6.1	Components.....	13
6.2	Mode of Operation of the BIOM® 5	14
6.3	Adjustments to microscopes	15
7	Transport and Storage.....	16
8	Initial Operation	16
8.1	Before Initial Operation.....	16
8.2	Before First Use	16
9	Use of the BIOM® 5.....	17
9.1	Choose the Appropriate Optics.....	17
9.2	Mounting the BIOM® 5.....	18
9.3	Under Sterile Conditions: Test the Safety Functions	21
9.4	Connect the BIOM® 5 to the microscope.....	23
9.5	Swing the BIOM® 5 to the Parked Position	25
9.6	Make the Basic Settings at the Microscope	25
9.7	Instructions for Focussing the BIOM® 5m/ml.....	26
9.8	During the Surgery	27
9.9	After the Surgery	27
10	Troubleshooting.....	29
11	Change the Drive Module.....	32
12	Cleaning, Sterilisation and Maintenance	32
13	Disposal of Used Devices	32
14	Guarantee and Service.....	33
14.1	Guarantee provisions	33
14.2	Assumption of Liability for Functions and Damage.....	33

15	Order Information, Accessories and Replacement Parts.....	34
15.1	Basic unit.....	34
15.2	Accessories BIOM® 5c / BIOM® 5cl.....	34
15.3	Optical accessories BIOM® 5m/BIOM® 5c.....	34
15.4	Optical accessories BIOM® 5ml/BIOM® 5cl.....	34
15.5	Accessories: Ophthalmoscopy lenses (steamautoclavable).....	34
15.6	Adaption accessories for BIOM® 5.....	35
15.7	Accessories for sterilisation	36
15.8	Image Reversal Systems.....	36
15.9	Connection Components, optional	36
15.10	Spare and Wear Parts	36
16	Technical Data	38
16.1	Dimensions of the BIOM® 5.....	38
16.2	Weight	38
16.3	Conformity	38
16.4	BIOM® 5c and BIOM® 5cl: Classification according to IEC 60601 - 138	
16.5	Miscellaneous	38

1 Scope of Delivery

Product and accessories	Order no.
BIOM® 5c	
■ Version BIOM® 5c	55400
■ Version BIOM® 5cl	55403
BIOM® 5m	
■ Version BIOM® 5m	55462
■ Version BIOM® 5ml	55463
■ Instruction Manual	G/55400/EN
■ Conditioning Instructions	G/55185/XXXX/EN
■ Box with cover	

Needed supplementary accessories	see
Reduction lens and front lens	<i>chap. 9.1, page 17</i>
Adaptor for surgical microscope (if necessary, with additional adaption modules)	<i>chap. 15.6, page 35</i>

Optional accessories	see
Drive belt	<i>chap. 15.2, page 34</i>
Cable support	<i>chap. 15.2, page 34</i>

Needed supplementary product	see
Stereoscopic Diagonal Inverter for erecting the image	<i>chap. 15.8, page 36</i>

We reserve the right to make changes to deliverables as a part of any technical improvements.

- ➔ If transport damage is discovered from the shipment, please file a complaint with the shipping company immediately.
- ➔ Have the damage confirmed on the bill of lading so that an orderly handling of the complaint for damages is possible.

2 BIOM® 5 Symbols

2.1 On the device/nameplate

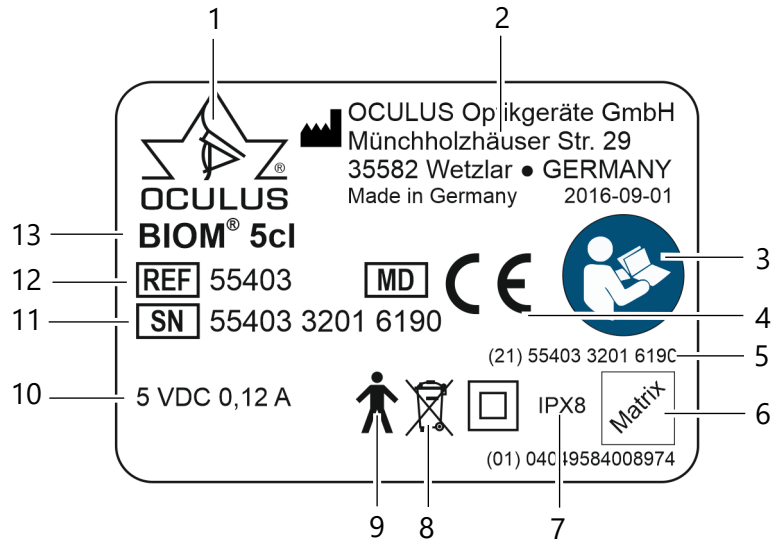
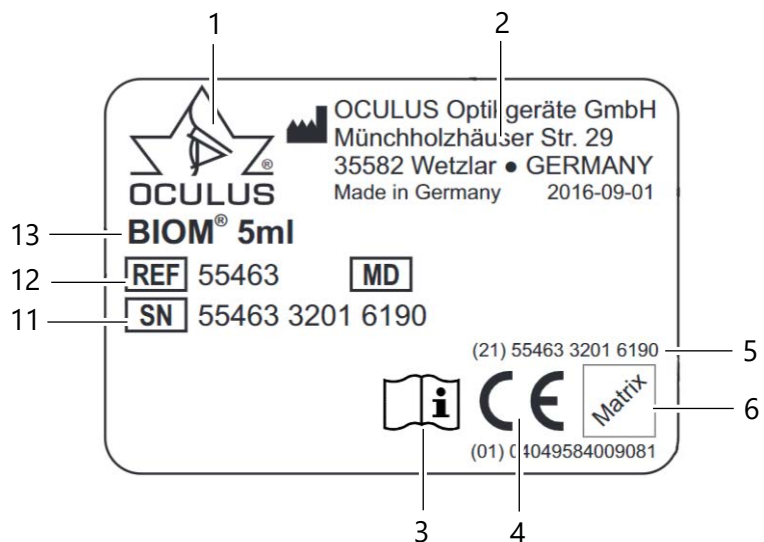









Fig. 2-1: Examples: BIOM® 5ml and BIOM® 5 symbols

- | | | | |
|---|----------------------------------|----|----------------------------------------------------------|
| 1 | Company logo | 8 | Disposal with household waste is prohibited |
| 2 | Manufacturer address | 9 | Applied part of the type B (BIOM® 5c and BIOM® 5cl only) |
| 3 | Read the instruction manual | 10 | Power supply |
| 4 | CE mark | 11 | Serial number of the device |
| 5 | UDI-Nummer | 12 | Reference number |
| 6 | Matrix for device identification | 13 | Name of device |
| 7 | Protection class | | |



2.2 On the packaging

Symbols	Notes	Symbols	Notes
Transport 	Permitted temperature range for transport	Storage 	Permitted temperature range for storage
	Keep dry		Limit of humidity
	This way up		Limit of air pressure
	Fragile		

3 Structure of the Documentation

The following documents are supplied with the BIOM® 5:

- **Instruction Manual:** The design of the unit is described in detail in this document. You will also find all safety-related information for use of the BIOM® 5.



Attention

All safety-related instructions for use of the BIOM® 5 are given in the instruction manual for the unit. It is therefore imperative that you read and understand the whole instruction manual before you use the BIOM® 5.

-
- **Conditioning Instructions:** These conditioning instructions explain how to condition the BIOM® 5. It is valid for all re-usable components and accessories of the BIOM® 5 that must be sterile for use. You will also find an itemized list of the articles concerned in the conditioning instructions. You can download the conditioning instructions at www.oclussurgical.de/technical-support or request them from OCULUS Optikgeräte GmbH, Wetzlar.

4 Safety Instructions

- ➔ Carefully read through the instruction manual.
- ➔ Keep the instruction manual in good condition, near to the device.
- ➔ Please read the separate operating instructions for the SDI® 4 or BIOM® connecting spacer and accessories.
- ➔ Please read the special packing notice included with the adaptor and accessories.

4.1 Pictograms in this manual



Attention

Denotes a potentially hazardous situation which can easily result in minor physical injury or property damage.



Note

Denotes situations which could result in incorrect findings, denotes user instructions and useful or other important information.



Denotes important information about the product and its use, which require special attention.

4.2 Safety Instructions for Use



Attention

Risk of personal injury or property damage due to improper operation
➔ Observe the following safety instructions.



Attention

Risk of personal injury or property damage due to equipment modifications that could jeopardize safety
➔ This equipment may not be modified without the permission of the manufacturer.

Any serious-incident that has occurred in relation to the device should be reported to the manufacturer (vigilance@oculus.de) and the competent authority of the region in which the user and/or patient is established.

4.3 Instructions for operating personnel

- Ensure that the BIOM® 5 is used only by duly trained physicians and operating theatre personnel, who, due to their training or their knowledge and practical experience, can guarantee proper handling of the device. Only OCULUS or an authorized dealer is allowed to train the personnel.

4.4 Transport and storage instructions

Refer to the notes in *chap. 7, page 16*.

4.5 Instructions for setup and connection

- Comply with the legal provisions in force in your country, and with the hygiene and waste disposal regulations of the hospital or clinic.
- Never mount and dismount the BIOM® 5 over the patient. Assembly of the holder and instruction in the use of the BIOM® 5 and its accessories will be undertaken by an OCULUS employee or by a duly authorized OCULUS representative.
- BIOM® 5c and BIOM® 5cl: Do not use excessive force to connect the electrical connectors to the OCULUS SDI® 4c or BIOM® connecting spacer.
If connection is not possible, check whether the plug fits in the socket.
If you find damage to the plug connector, have the damage corrected by our service department.

4.6 Operation and maintenance information

- Before initial operation: Let OCULUS or an authorized dealer train you in the operation of the BIOM® 5.
- Never operate a damaged BIOM® 5.
- Only operate the BIOM® 5 using original accessory parts supplied by us, and when the device is in technically perfect working order.
- Only operate the equipment after you have read and understood the instruction manual.
- The BIOM® 5 and all sterilisable BIOM® 5 components must be sterilised:
 - Before the first use
 - After every use
- It is imperative that you heed the cleaning, disinfection and sterilisation instructions given in the conditioning manual.

4.7 Instructions for Use



Attention

Risk of eye damage if the working distance between the BIOM® 5 and the patient changes

When the BIOM® 5 is swung into the working position (into the beam path), the following instructions must be followed:

- Do **not** use the coarse adjustment knob at the microscope stand to adjust the height.
- Do **not** adjust the height of the stand arm, either by motor or manually, over the surgical area.
- Do **not** change the patient's position by adjusting the height of the operating table.

-
- ➔ Pay attention to the focussing instructions, [chap. 9.7, page 26](#). More information can be found in the [Application tips: BIOM® 5](#) and can be downloaded from the OCULUS website.

4.8 Troubleshooting

- ➔ If a fault occurs that you cannot rectify with the help of the troubleshooting table ([page 29](#)), the unit must not be used! Clearly mark the unit as non-operational and get in touch with our service personnel.

4.9 Instructions for disassembly and disposal

- ➔ Dispose of the equipment in compliance with the corresponding legal requirements. Comply with the hygiene and disposal regulations of the hospital or clinic.

4.10 EMC and electrical safety information

The BIOM® 5c, a connected SDI® 4c or BIOM® connecting spacer and a microscope constitute a medical electrical system (ME system) in accordance with IEC 60601-1. If you connect additional devices, those devices become part of the ME system.

- ➔ Make sure that all devices of the ME system meet the requirements of IEC 60601-1 or IEC 60950-1.

5 Purpose

This binocular indirect ophthalmomicroscope (BIOM® 5) is used for non-contact observation of surgeries in the posterior segment of the eye.

The BIOM® 5 is intended for use with compatible surgical microscopes in hospitals, clinics or other institutions for human medicine

The surgical microscopes must be declared as adaptable by OCULUS Optikgeräte GmbH (*chap. 6.3, page 15*).

Only operate the device using original accessory parts supplied by us, and when the device is in technically perfect working order.

➔ Heed the safety instructions listed above.

5.1 Intended medical indication

The BIOM 5 is a tool to observe the posterior segment of the eye during surgeries (vitrectomy) in cases such as

- retinal detachment
- proliferative vitreoretinopathy (PVR)
- ILM peeling
- macular hole

5.2 Contraindication

none known

5.3 Possible side effects

none known

5.4 Intended users

Make certain that the BIOM® 5 is used exclusively in clinics and by clinical persons or eye specialists,

- who, due to their training or their knowledge and practical experience, can guarantee proper handling of the device.
- who have been instructed by OCULUS staff or an authorized dealer before the initial operation.

5.5 Patient group

No restrictions on age, weight, health and condition.

6 Device Description

6.1 Components

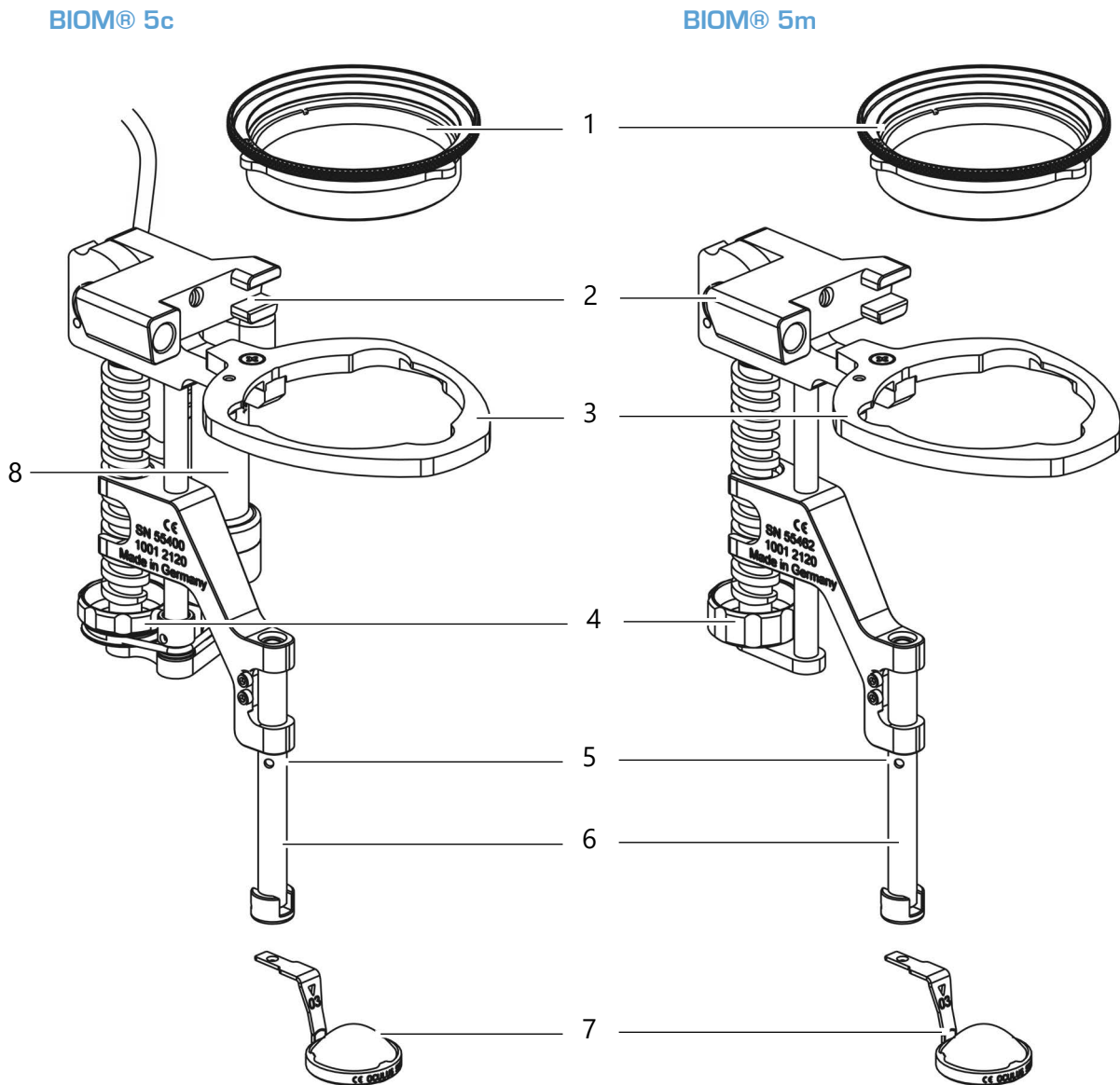

Fig. 6-1: Device Overview, BIOM® 5 with reduction lens and ophthalmoscopy lens

- | | |
|------------------------------------------------------------------------------------------------------------------------------------------------------------------------------------------------------------|-------------------------------------------------------------------------------------------------------------------------------------------------------------------------------------------------------------------------------------------|
| <ul style="list-style-type: none"> 1 Reduction lens
(not supplied with the BIOM®) 2 Housing with swivel mechanism 3 Lens receptacle 4 Focus adjustment wheel | <ul style="list-style-type: none"> 5 Control mark 6 Lens holder with safety rod 7 Ophthalmoscopy magnifying lens
(not supplied with the BIOM®) 8 Drive module (BIOM® 5c and BIOM® 5cl only) |
|------------------------------------------------------------------------------------------------------------------------------------------------------------------------------------------------------------|-------------------------------------------------------------------------------------------------------------------------------------------------------------------------------------------------------------------------------------------|

6.2 Mode of Operation of the BIOM® 5

The BIOM® 5 is used in conjunction with an SDI® (Stereoscopic Diagonal Inverter) to erect the image for non-contact, wide-angle observation of the fundus and vitreous body. If the matching OCULUS SDI® is used, full compatibility with the BIOM® 5 models is guaranteed. The combination of surgical microscope and the optical components of the BIOM® 5 allows examination of the vitreous chamber under stereoscopic conditions. The BIOM® 5 works as an indirect ophthalmomicroscope without corneal contact during the surgery.

The patient's eye ball can be moved freely during the surgery. Peripheral fundus portions are thus easy to examine. This combined optical system achieves a fundus observation of 125° up to 130° in total.

The optical system of the BIOM® 5 consists of the reduction lens and the front lens. The reduction lens provides a virtually constant distance between the patient's eye and the surgical microscope when the BIOM® 5 is swung in or swung out. The reduction lens reduces the focal length of the microscope objective lens.

The position of the reduction lens with respect to the surgical microscope is preset.

The height adjustment of the front lens is used for focussing the BIOM image. The distance between the surgical microscope and the front lens is set using the adjusting wheel at the BIOM® 5.

For the BIOM® 5c/cl only:

Press the combination foot switch to focus by means of the electric motor.

This height adjustment of the front lens brings the fundus image into the focal point of the microscope objective.

As the image is completely reversed when the BIOM® 5 is used, optimal use is only guaranteed in conjunction with a stereoscopic diagonal inverter (SDI®). The SDI® rights the complete image reversal and can be switched on and off as required.

If a BIOM® connecting spacer is used, this serves to focus the BIOM® 5c, the image is erected by an inverter.

6.3 Adjustments to microscopes

The unit can be attached to the following microscopes (*chap. 15.6, page 35*):

Manufacturer	Microscope		
Alcon	LuxOR™	LuxOR® Revalia™*	
Bausch + Lomb	SeeLuma™		
Beyeonics	Beyeonics One™		
Haag-Streit	Ophtamic 900 Allegra 900	Hi-R 900	Hi-R NEO 900
Huvitz	HOM-700		
Kaps	SOM		
Leica	M220, M500 / M501, M620	M841, M820*, M822*	M844*, Proveo 8*
Takagi	OM 8/OM 9	OM 18/OM 19	
Topcon	OMS 600/OMS 610/OMS 650	OMS 110 OMS 710	OMS 800 Standard OMS 800 Pro OMS 850 Standard OMS 850 Pro
Zeiss	ARTEVO 800® ARTEVO 850® OPMI 1/6 OPMI CS mit Retrolux 1/3/CS	OPMI MD/MDO/MDU OPMI VISU 150/VISU 160 OPMI VISU 200/VISU 210	OPMI Lumera™ OPMI Lumera i™ OPMI Lumera T™ OPMI Lumera 700™ OPMI Lumera® 300 Advanced

7 Transport and Storage



Attention

Equipment damage due to improper transport and storage

- Transport the BIOM® 5 with care.
- Store the BIOM® 5 in accordance with the transport and storage requirements, the applicable national regulations and the regulations of your hospital.

Ambient Conditions, Transport and Storage Requirements for Optics

	Operating conditions	Transport requirements	Storage requirements
Temperature	+10°C to +35°C	-40°C to +70°C	-10°C to +55°C
Humidity	30% to 70%	10% to 95%	10% to 95%
Air pressure	700 hPa to 1060 hPa	500 hPa to 1060 hPa	700 hPa to 1060 hPa

These values apply to all BIOM® 5 versions.

8 Initial Operation

8.1 Before Initial Operation

- Remove the BIOM® 5 and its accessories from the packaging.
- Clean, disinfect and sterilise the BIOM® 5 before putting it into use for the first time, [chap. 12, page 32](#).

Installation and instruction in the use of the BIOM® 5 and its accessories will be undertaken by an OCULUS employee or by an OCULUS authorized dealer.

8.2 Before First Use

- Make sure that the BIOM® 5 and its components have been cleaned, disinfected and sterilised, also refer to the conditioning instructions

9 Use of the BIOM® 5

9.1 Choose the Appropriate Optics

- ➔ Use the appropriate reduction lens for the surgical microscope's objective.
- ➔ Select the appropriate front lens for the surgery.

The following front lenses can be steam-autoclaved:

	53603 WiFi HD		53602 WFE
	53606 Hi Res		53605 WiFi HD Mini
	53604 90D		

Disposable lens Sets

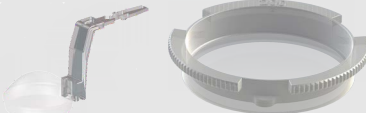
	Objective Lens	BIOM® Model	BIOM® Optic Set
	f = 175 mm	BIOM® 5m (55462) BIOM® 5c (55400)	HD Professional 54411
	f = 200 mm	BIOM® 5ml (55463) BIOM® 5cl (55403)	HD Professional 54412
	f = 200 mm	BIOM® 5m (55462) BIOM® 5c (55400)	HD Flex 54415

9.2 Mounting the BIOM® 5

➔ Make sure that all components are present and are sterile.

Example: Components of the BIOM® 5cl

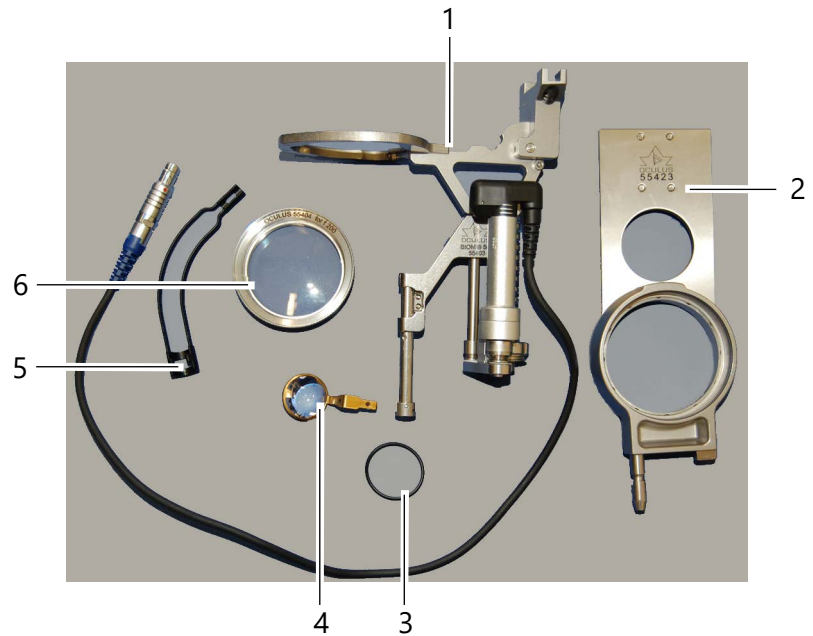
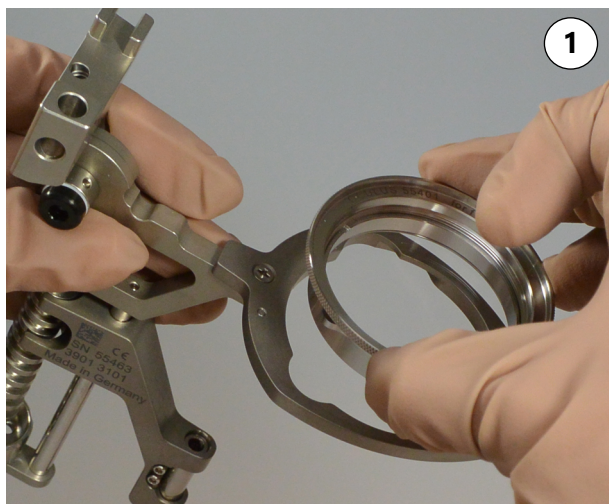
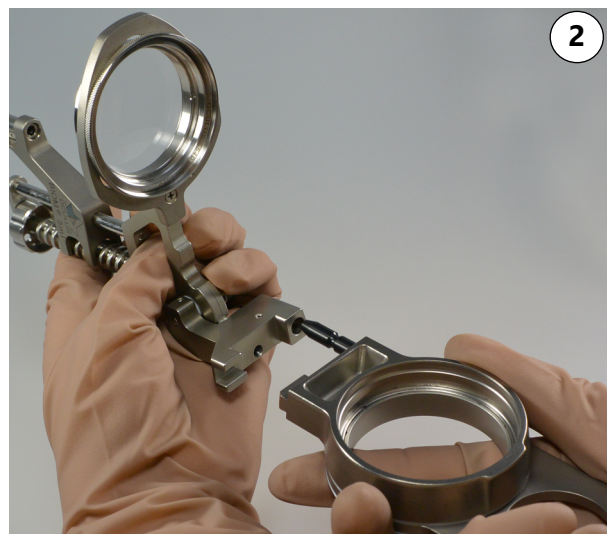

Fig. 9-1: Components of the BIOM® 5cl

- | | |
|------------------------------------|----------------------------------|
| 1 BIOM® 5cl | 4 Ophthalmoscopy magnifying lens |
| 2 Adaptor plate | 5 Cable duct (BIOM® 5c/cl only) |
| 3 Drive belt
(BIOM® 5c/cl only) | 6 Reduction lens |



→ Insert the reduction lens. Then turn the reduction lens clockwise until it reaches the stop.



→ Plug in the adaptor plate until it reaches the stop.

Attention



Risk to the patient if the BIOM® 5 is plugged in incorrectly

If you do not plug in the BIOM® 5 correctly, you will get a decentred fundus image.

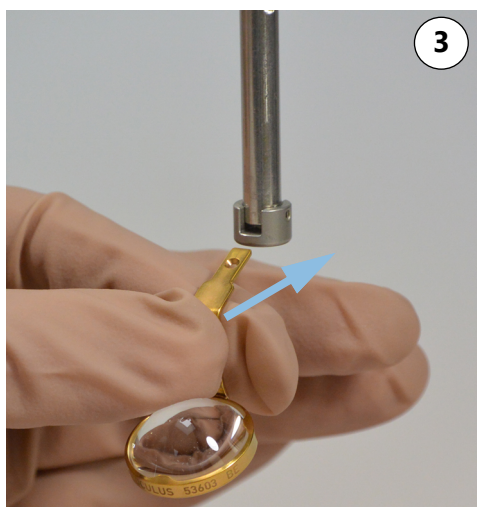

→ Insert the lens until it reaches the stop.
Fig. 9-2: Mounting the components



The BIOM® 5ml is now fully mounted.

Additionally for BIOM® 5c/cl:

You must insert the drive belt. You can put on a cable duct. The cable duct is used to keep the connecting cable of the drive unit at the BIOM® 5c/cl away from unsterile parts of the microscope.



→ Insert the drive belt



- Fasten the cable duct at the connector plug first.
- Then push the semi-open duct part over the cable.

Fig. 9-3: Mounting the drive belt and cable duct

9.3 Under Sterile Conditions: Test the Safety Functions



Attention

Risk of injury due to improper function

- ➔ Only use the BIOM® 5 when the following functions have been checked and are in proper working order.

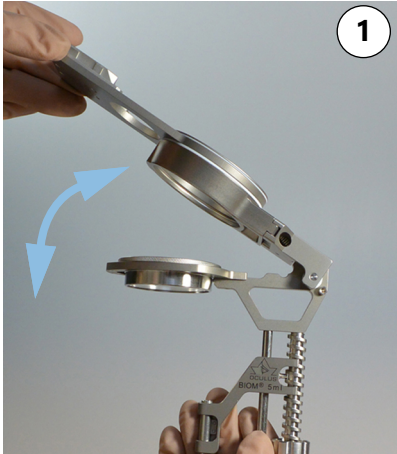

- ➔ Flip the BIOM® 5 towards the adaptor plate. Make sure that the housing body can be shifted without resistance.

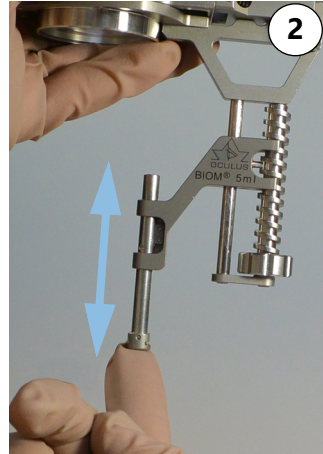

- ➔ Slide the safety rod of the lens holder up and down several times to check that it runs smoothly.

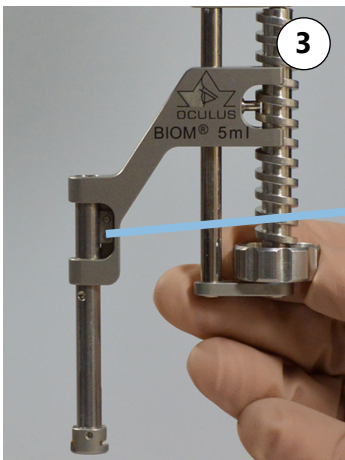

- ➔ Check that the knob turns easily and shorten the total length of the BIOM® 5 until the adjuster is at the fully up position.

- ➔ Check whether all fastening screws are present (e.g. screws at the feather key of the safety rod). The control mark (1) must be below the guide.

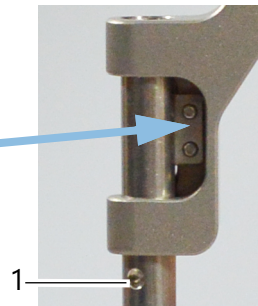

Fig. 9-4: Test the safety functions

- ➔ Before each use, check that
 - The unit is in technically perfect condition.
 - All connections and fasteners that can be loosened are properly tightened and are in a safe condition.
 - The dovetail mount for the adaptor is securely fastened at the microscope.

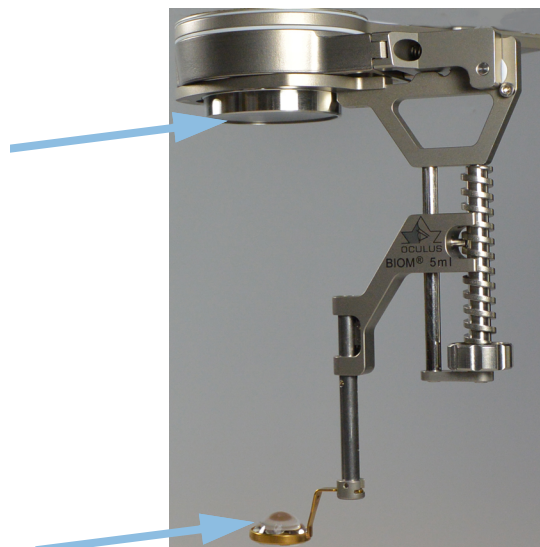

Fig. 9-5: Visual inspection of the lenses

- ➔ Check the reduction lens and the front lens for
 - correct fit and firm hold,
 - mechanical damage such as scratches and clouding of the glass.



- ➔ Do not use cloudy or scratched lenses.

9.4 Connect the BIOM® 5 to the microscope



Attention

Risk of injury to the patient if mounting is done incorrectly

→ Never mount the BIOM® 5 over the patient.



→ Push the sterile cap onto the knurled screw.

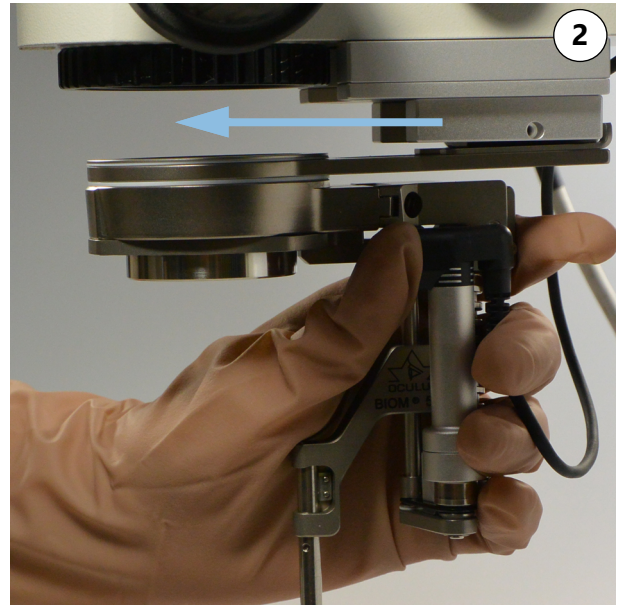

→ Push the adaptor plate with the BIOM® 5 into the dovetail mount at the microscope until it reaches the stop.

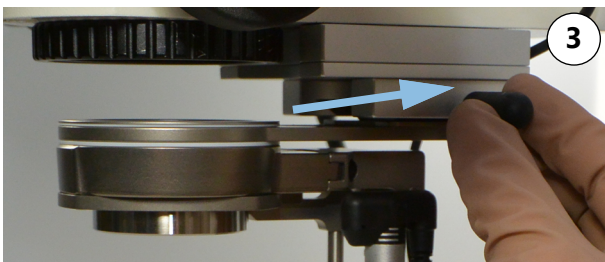

→ Secure the adaptor into place with the knurled screw.

Fig. 9-6: Connect the BIOM® 5 to the microscope

For the BIOM® 5c/cl only

For the BIOM® 5c/cl, you must connect the control cable with the SDI® 4c or BIOM® connecting spacer.

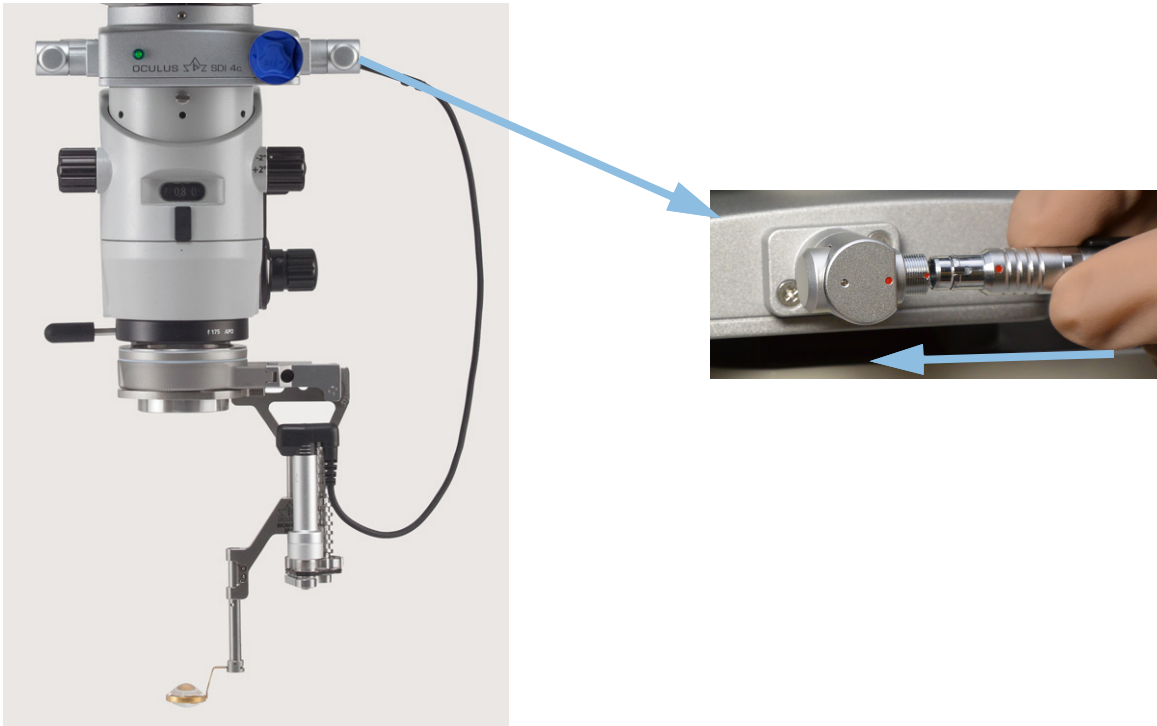

Fig. 9-7: BIOM® 5c/cl: Connecting the control cable (example: SDI® 4c)

- ➔ Plug the control cable into one of the side sockets on the SDI® 4c or BIOM® connecting spacer. Make sure that the cable does not come into contact with any unsterile parts of the microscope.
- ➔ Connect the cable to the SDI® 4c or BIOM® connecting spacer. The connector locks automatically.

9.5 Swing the BIOM® 5 to the Parked Position

- ➔ During extra-ocular surgery phases, swing the BIOM® 5 out of the beam path into the parked position.
- ➔ When swinging out the BIOM, push in the safety rod, including the front lens, with you finger, until the rod reaches the limit stop.



Fig. 9-8: BIOM® 5cl in the working position



Fig. 9-9: BIOM® 5cl at parked position



When swinging into the beam path:

- ➔ Lift up safety rod and only release it again when the swung-in end position has been reached.

9.6 Make the Basic Settings at the Microscope

- ➔ Adjust the microscope to the anterior eye segment and perform the surgery steps under microscope illumination, including starting the infusion.

9.7 Instructions for Focussing the BIOM® 5m/ml

Focussing on the BIOM® 5m is done manually with the adjusting knob, and on the BIOM® 5c/cl, also by means of a foot pedal.

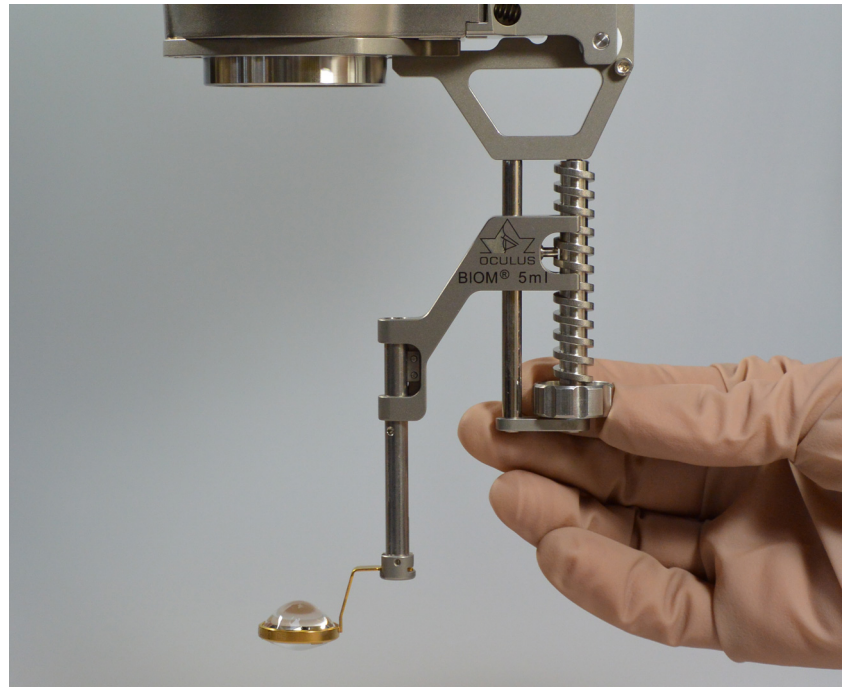

Fig. 9-10: Focussing with the adjusting knob



Attention

Risk of eye injury due to poor visibility conditions

The use of intraocular instruments in poor visibility conditions for the surgeon can result in injury to the patient's eyes.

- When focussing with the BIOM® 5, heed the following instructions.
-
- Before you begin to focus the BIOM® 5, check the distance from the ophthalmoscopy magnifying lens to the patient's eye.
 - When focussing the BIOM® 5, make sure that:
 - The microscope is left at this position (height) after the surgical steps have been performed at the anterior section.
 - The BIOM® 5 has been set to the shortest length before you swing it into the working position.
 - The ophthalmoscopy lens does not touch the eye.
 - You do **not** adjust the height of the microscope.
 - You do **not** use the microscope's focussing function.

Special Case "Air-filled eye"

- ➔ During the fluid-air-exchange: Turn the focussing knob of the BIOM® 5 until the front lens reaches the highest position.
- ➔ Use the microscope's fine focus to enlarge the image section.

For the BIOM® 5c/cl only (focussing with electric motor):

Focussing of the BIOM® 5c/cl is done by the surgeon by means of the combination foot switch while observing through the microscope.

- Only use the BIOM® 5c/cl's motorized focussing function when the front lens is far enough away from the patient's eye.
- The surgeon may only use the motorized focussing function when the distance between the ophthalmoscopy lens and the eye is **simultaneously** monitored.
- It must be ensured that the surgeon can stop the motorized focussing function at any time.



Attention

Risk of eye damage if the working distance between the BIOM® 5 and the patient changes

When the BIOM® 5 is swung into the working position (into the beam path), the following instructions must be followed:

- Do **not** use the coarse adjustment knob at the microscope stand to adjust the height.
- Do **not** adjust the height of the stand arm, either by motor or manually, over the surgical area.
- Do **not** change the patient's position by adjusting the height of the operating table.

9.8 During the Surgery

- ➔ Make sure that the cornea is sufficiently moistened with a suitable solution.

9.9 After the Surgery

After the surgery, you must remove the BIOM® 5 from the microscope. You must bring the BIOM® 5 and its components to the conditioning station immediately after the surgery.



Attention

Incorrect detaching is hazardous to the patient

- ➔ Never detach the BIOM® 5 over the patient.

- ➔ To dismount the BIOM® 5, swing it to its standby position.

BIOM® 5m/ml

- ➔ Pull the BIOM® 5 off the adaptor plate.
- ➔ Loosen the knurled screw, *fig. 9-6, page 23, image 3.*

- Pull the adaptor plate off the dovetail mount.

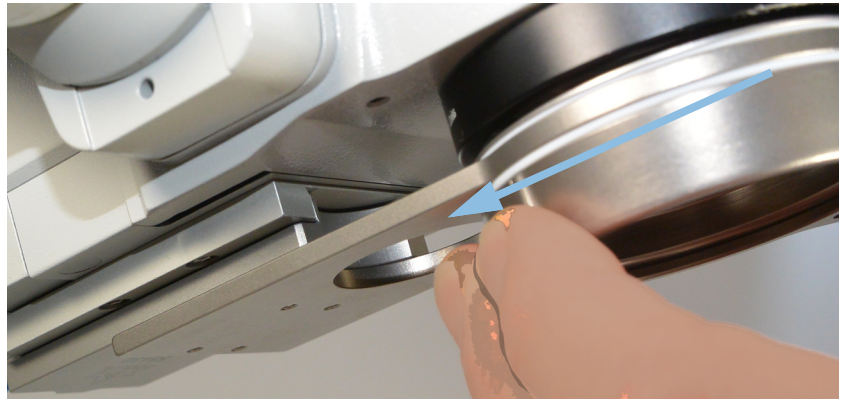

Fig. 9-11: Pull off the adaptor plate

- Bring the BIOM® 5 and its components to the conditioning station immediately.

BIOM® 5c/cl

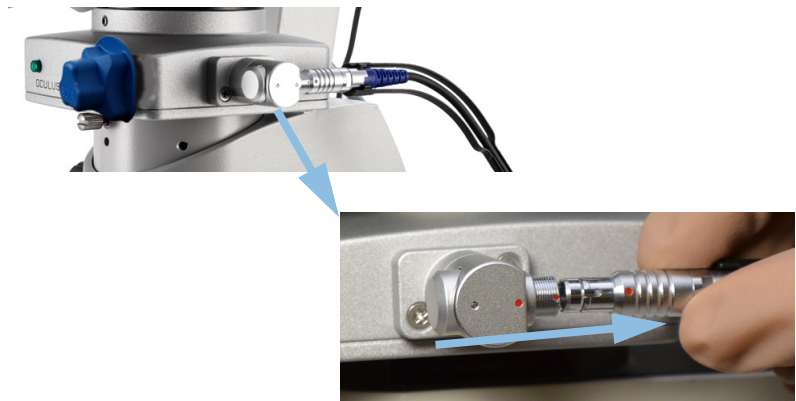

Fig. 9-12: BIOM® 5c/cl: Disconnect the plug-in connectors

Unplug the connector of the BIOM® 5c/cl from the socket at the SDI® 4c or BIOM® connecting space housing. To unlock the plug, take hold of the outer plug sleeve.



Note

Risk of damage to the unit if the plug is pulled incorrectly
If you pull on the cable, you could damage it and the complete drive module would then have to be exchanged.

- Always grip the plug of the BIOM® 5c/cl at the sleeve, in order to release the lock.

- Pull the BIOM® 5 off the adaptor plate
- Loosen the knurled screw, *fig. 9-6, page 23, image 3.*
- Pull the adaptor plate out of the dovetail mount, *fig. 9-11, page 28.*
- Bring the BIOM® 5 and its components to the conditioning station immediately.

10 Troubleshooting



Attention

If a fault occurs which you are unable to correct by following the instructions below, label the device as “out of order” and contact our service department. (Address: [page 40](#)).

- ➔ Never operate a damaged BIOM® 5.
- ➔ Before returning to OCULUS: Condition the BIOM® 5 and its components in accordance with the conditioning instructions.

Troubleshooting guide – BIOM® 5

Fault	Possible cause	Remedy
The safety rod of the BIOM® 5 is stuck BIOM® 5 must not be used in this state!	<ul style="list-style-type: none"> ■ Deposits on the BIOM® 5 due to inadequate sterilisation ■ Foreign body in safety rod extension channel ■ Safety rod is bent 	<ul style="list-style-type: none"> ■ Carefully mechanical cleaning and change to a better demineralised water, clean the BIOM® 5 ultrasonically ■ Careful mechanical cleaning and removal of the foreign body ■ Clean the BIOM® 5 in the ultrasound bath ■ Treat the rod with a suitable, silicone oil-free lubricant prior to the next sterilisation ■ Send the BIOM® 5 to OCULUS Service
Loose adaptor Dovetail mount wobbles	<ul style="list-style-type: none"> ■ The locking screws are loose ■ Screws are loose 	<ul style="list-style-type: none"> ■ Tighten the locking screws by hand ■ Tighten the screws with a suitable screwdriver
Image is cropped or out-of-center	<ul style="list-style-type: none"> ■ The SDI® or BIOM® connecting spacer , other components or the BIOM® 5 adapter are incorrectly mounted at an angle ■ The magnifying lens clip is bent or mechanically damaged 	<ul style="list-style-type: none"> ■ Correct the assembly ■ Send the lens to OCULUS Service for readjustment

Fault	Possible cause	Remedy
Unclear image	<ul style="list-style-type: none"> ■ Soiled glass surfaces ■ The glass surfaces have been damaged during sterilisation ■ The glass surfaces have been mechanically damaged ■ Ophthalmoscopy lens is touching the eye ■ Dry patient cornea 	<ul style="list-style-type: none"> ■ Clean the glass surfaces ■ Change the sterilisation method, replace lenses if necessary ■ Greater care in use and storage of lenses; replace if necessary ■ Choose the correct work distance, clean the lens ■ Moisten the cornea regularly with a suitable solution
Unfocussed image	<ul style="list-style-type: none"> ■ Incorrect adjustment of the BIOM® 5 ■ A reduction lens is not being used ■ The reduction lens is not compatible with the microscope objective 	<ul style="list-style-type: none"> ■ Focus the BIOM® 5 in accordance with the instructions ■ Use a reduction lens ■ Check the engraving on the reduction lens and exchange the reduction lens, if necessary (see chap. 9.1, page 17)
Fundus view is too narrow	<ul style="list-style-type: none"> ■ Too much distance between the ophthalmoscopy lens and the eye ■ Magnification of the microscope system to high 	<ul style="list-style-type: none"> ■ Carefully reduce the distance using the microscope fine adjustment mechanism ■ Reduce magnification of the microscope
The eye or the lens reflects strongly	<ul style="list-style-type: none"> ■ The microscope light is on 	<ul style="list-style-type: none"> ■ Turn the light off, illuminate only intraocular
The BIOM® 5 cannot be detached from the adaptor	<ul style="list-style-type: none"> ■ BIOM® 5 has not been tilted to the side ■ Mineral deposits on the connection components of the BIOM® 5 and adaptor 	<ul style="list-style-type: none"> ■ Tilt the BIOM® 5 to the side ■ Place the BIOM® 5 and adaptor into an ultrasound bath (for approx. 5 min)

Fault	Possible cause	Remedy
No function whatsoever when the combination control unit is actuated	<ul style="list-style-type: none"> ■ The combination control unit is not connected to the SDI® 4c or BIOM® connecting spacer ■ The SDI® 4c or BIOM® connecting spacer is not connected to the 6V-15V power supply ■ Power failure or power socket is not active ■ These are not active when the sockets at the microscope stand are in use 	<ul style="list-style-type: none"> ■ Establish the connection to the SDI® 4c or BIOM® connecting spacer ■ Establish the connection to the 6V-15V power supply ■ Inform the in-house electrician ■ Use the 6V-15V plug transformer ■ Use the mechanical adjusting element or adjusting wheel ■ Activate the sockets in accordance with the instructions for the stand ■ Contact the microscope manufacturer for assistance
Malfunction when using the combination control unit	<ul style="list-style-type: none"> ■ 5-pole plug has been forcibly plugged in the wrong way round 	<ul style="list-style-type: none"> ■ Plug it in the right way round (pay attention to the lug and slot of the polarity reversal protection)
Motorized focussing not possible with the BIOM® 5c/cl when using the combination control unit	<ul style="list-style-type: none"> ■ BIOM® 5c/cl connector not plugged into the SDI® 4c or BIOM® connecting spacer properly ■ Defective drive belt ■ Drive belt missing ■ Connecting cable damaged ■ Defective drive module 	<ul style="list-style-type: none"> ■ Plug in the connector correctly ■ Install a new, sterile drive belt, or focus manually using the focussing knob at the BIOM® 5c/cl ■ Install a sterile drive belt ■ Exchange the drive module ■ Exchange

11 Change the Drive Module

- Proceed in the manner described in the assembly instructions for the drive module.

12 Cleaning, Sterilisation and Maintenance



Attention

Risk of infection due to improper reconditioning

- Bring the BIOM® 5 and its components to the conditioning station immediately after the surgery.
- Pay attention to the separate conditioning instructions.

Sterilization and Disinfection Procedures

BIOM® 5	Steam autoclave, 134°C
Reduction lens (only the reduction lenses listed in this manual)	Steam autoclave, 134°C
Ophthalmoscopy lens (only the lenses listed in this manual)	Steam autoclave, 134°C
Adaptor	Steam autoclave, 134°C
Drive belt	Steam autoclave, 134°C
Cable support	Steam autoclave, 134°C

13 Disposal of Used Devices

- Dispose of the BIOM® 5 in compliance with the corresponding legal requirements. Comply with the hygiene and disposal regulations of the hospital or clinic.

BIOM® 5c/5cl

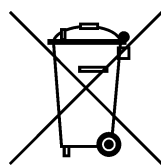

In accordance with Directive 2012/19/EC of the European Parliament and of the Council, and also the Law of the Federal Republic of Germany on the Commercialization, Recall and Environmentally Compatible Disposal of Electrical and Electronic Equipment, old electrical and electronic equipment must be sent out for recycling and may not be disposed in household trash.

14 Guarantee and Service

14.1 Guarantee provisions

Please note the following guarantee provisions:

- Prior to and while operating the device, it is important that you heed the instruction manual and safety instructions.
- The BIOM® 5 carries a guarantee to which you are entitled in accordance with the legal provisions.
- If modifications are made to the BIOM® 5 by unauthorized persons, all guarantee claims shall be voided. Improper modifications and repairs may result in considerable hazards to users and patients.
- Any transport damage must be reported immediately to the shipping company. Have the transport damage noted on the bill of lading so that complaint handling and compensation of damages can proceed in an orderly manner.
- In general, our Business and Shipping Terms applicable on the date of purchase shall apply.

14.2 Assumption of Liability for Functions and Damage

OCULUS will only accept responsibility for the safety, reliability and serviceability of the BIOM® 5 if the unit is used in compliance with the following terms:

- Only use the equipment in conformance with this instruction manual.
- There are no parts on the BIOM® 5 that require maintenance or repair by the user. If assembly work, modifications, adjustments, repairs, changes or service are performed by unauthorized personnel, or if the BIOM® 5 is improperly maintained or handled, then any liability by OCULUS is voided.
Exception: Exchange of the BIOM® 5 drive module
- If the above-mentioned work is performed by authorized persons, then a certification of the work shall be requested from the service technician in which any changes to factory defaults or to operating ranges shall be stated. This certification must contain the date of performance and statement of the performing firm, with signature.
- If requested, OCULUS will provide to the service technician a list of spare parts and additional descriptive material for this purpose.
- Make certain that only original OCULUS parts are used.

15 Order Information, Accessories and Replacement Parts

15.1 Basic unit

Article	Order no.
BIOM® 5c	55400
BIOM® 5cl	55403
BIOM® 5m	55462
BIOM® 5ml	55463

15.2 Accessories BIOM® 5c / BIOM® 5cl

Article	Order no.
Drive belts (QTY 10)	54176
Cable duct (QTY 5)	54178

15.3 Optical accessories BIOM® 5m/BIOM® 5c

Article	Order no.
Reduction lens for f = 175 mm	55401
Reduction lens for f = 200 mm	55405

15.4 Optical accessories BIOM® 5ml/BIOM® 5cl

Article	Order no.
Reduction lens for f = 200 mm	55404

15.5 Accessories: Ophthalmoscopy lenses (steamautoclavable)

Article	Order no.
WFE for BIOM® 5	53602
WiFi HD for BIOM® 5	53603
90 D for BIOM® 5	53604
WiFi HD Mini	53605
Hi Res for BIOM® 5	53606

15.6 Adaption accessories for BIOM® 5

Article	Order no.
Adaptor plate	55423
Adaptor plate	55424
Adaptor plate	55425
Adaptor plate	55426
Adaptor plate Bausch + Lomb	10028431
Adaptor Alcon LuxOR® Revalia™	10007617
Dovetail mount Alcon LuxOR® Revalia™	10008981
Adaptor plate Zeiss	55431
Adaptor plate Zeiss RESIGHT®	55432
Dovetail mount	54511
Spacer	54535
Spacer	54536
Dovetail mount	54537
Dovetail mount	54538
Spacer	54539
Dovetail mount Alcon LuxOr®	54857
Adaptor set Zeiss	55420
Adaptor set Zeiss	54840
Adaptor set Leica	55445
Adaptor set Leica	55446
Adaptor set Leica	55447
Adaptor set Leica	55449
Adaptor set Alcon LuxOR® Revalia™	55429
Adaptor set Haag Streit	55440
Spacer Haag Streit	54639
Adaptor set Takagi	55417
Adaptor set Takagi / Inami	55418
Adaptor set Takagi	55419
Adaptor set Topcon	55441
Adaptor set Topcon	55442
Dovetail mount	085453401010

Article	Order no.
Adaption spacer Zeiss	55433

15.7 Accessories for sterilisation

Product and accessories	Order no.
Sterilization container with insert for BIOM® 5 and accessories	55180
Insert for sterilization container	55185
Paper filters for sterilization container (QTY 100)	55190

15.8 Image Reversal Systems

Product	Order no.	Product	Order no.
SDI® 4c (6-15 V, 0.5 A)	54320	SDI® 4c (6-15 V, 0.5 A) Kaps	54315
SDI® 4e (6-15 V, 0.5 A)	54300	SDI® 4m (mechanical) Kaps	54305
SDI® 4c (6-15 V, 0.5 A) Leica	54330	SDI® 4m	54302
SDI® 4e (6-15 V, 0.5 A) Leica	54310	SDI® 4m (mechanical) Leica	54312
SDI® 4cli (6-15 V, 0.5 A) Leica	54331	SDI® 4b (mechanical)	54301
SDI® 4eli (6-15 V, 0.5 A) Leica	54332	SDI® 4b (mechanical) Leica	54311

15.9 Connection Components, optional

Accessories	Order no.
BIOM® connecting spacer	54841
BIOM® connecting spacer Leica	54842

15.10 Spare and Wear Parts

Parts Designation	Order no.
Drive belt (10 pieces)	54176
Cable routing (5 pieces)	54178
Reduzierlinse für BIOM® 5m/ 5c für f = 175 mm	55401
Reducing lens for f = 200 mm, for BIOM® 5ml/ 5cl	55404
Reducing lens for f = 200 mm, for BIOM® 5m/ 5c	55405

Parts Designation	Order no.
WFE for BIOM® 5	53602
WiFi HD for BIOM® 5	53603
90 D for BIOM® 5	53604
WiFi HD Mini	53605
Hi Res for BIOM® 5	53606
Drive Module for BIOM® 5c/ cl	54405

16 Technical Data

16.1 Dimensions of the BIOM® 5

	BIOM® 5m and BIOM® 5c	BIOM® 5ml and BIOM® 5cl
Dimensions (W x D x H)	63 x 112 x 110 –145 mm	63 x 112 x 124–160 mm
Total height	approx. 123 –158 mm	approx. 137–173 mm
Travel of safety rod	approx. 29 mm	approx. 29 mm

16.2 Weight

Product	Weight	Product	Weight
BIOM® 5m	approx. 186 g	BIOM® 5cl	approx. 260 g
BIOM® 5ml	approx. 190 g	Reduction lens	approx. 30 g
BIOM® 5c	approx. 250 g	Front lens: depending on the model	approx. 3 — 10 g

16.3 Conformity

CE in accordance with Regulation (EU) 2017/745 on Medical Devices

The unit is a Class I product.



Conformity assessment procedure: (EU) 2017/745 MDR, Annex II and III

16.4 BIOM® 5c and BIOM® 5cl: Classification according to IEC 60601 - 1

Type of protection against electric shock	Protection class 2
Degree of protection against electric shock	Type B
Degree of protection against harmful penetration of water	IPX8
Power supply via SDI® 4 Power	0.6 W

16.5 Miscellaneous

Expected service life (except optical components)	4 years
---------------------------------------------------	---------

WWW.OCULUS.DE

OCULUS Optikgeräte GmbH

Münchholzhäuser Str. 29 · 35582 Wetzlar · GERMANY

Phone +49 641 2005-0 · Fax +49 641 2005-255

E-mail: sales@oculus.de · www.oculus.de

G/55400/EN - Rev04
Lot:

