

OCULUS Pentacam[®] Cornea OCT

High-Resolution Corneal Visualization



INSTRUCTIONS FOR USE

Preface

The Pentacam® Cornea OCT was manufactured and tested based on strict quality criteria.

Proper use of the device is essential for ensuring safe operation. For this reason, please thoroughly familiarize yourself with the content of the user information prior to commissioning. In particular, observe the safety instructions.

With the device, you receive the following user information:

- Instructions for Use: description of the management of patient data, the default settings in the Pentacam® program and the measuring procedure
- Instructions for Use for the Patient Data Management
- User Guide: description of all features of the examination and analysis software, along with detailed information about the Patient Data Management system
- Software Installation: description of how to install the Pentacam® Software and the corresponding drivers
- Floating License Key: description of how you can use the device within a network
- Interpretation Guide: presentation of real use cases

Minor deviations in the figures illustrated here to the device that was in fact delivered are possible for development reasons.

If you have any additional questions or require further information about your device, please feel free to call, email, or fax us. The OCVLUS Service Team will be happy to assist you.

OCVLUS Optikgeräte GmbH

Article number: 10031884 / US

Revision: Rev03

Release: 19.12.2025

Table of Contents

1	Scope of Delivery	7
2	Safety Instructions	9
2.1	Symbols.....	9
2.1.1	On the Device / Name Plate	9
2.1.2	On the Packaging.....	10
2.1.3	In this Manual.....	10
2.2	Safety Instructions for Use.....	11
2.2.1	Instructions for the Operation of an ME System	11
2.2.2	Instructions on Electrical Safety.....	12
2.3	Instructions for Cybersecurity.....	13
2.3.1	Precautionary Measures against Unauthorized Access.....	13
2.3.2	Precautionary Measures if the Computer is Connected to a Local or Internet Network.....	14
2.3.3	Device Security.....	14
2.3.4	Data Responsibility.....	15
2.3.5	Reporting and Handling of Security Incidents.....	15
3	Device Description	16
3.1	Device Components	16
3.2	Applied Parts	17
3.3	Principle of Operation.....	18
3.4	Intended Purpose.....	19
3.4.1	Intended Use.....	19
3.4.2	Intended Medical Indication.....	19
3.4.3	Contraindication	19
3.4.4	Possible Side Effects.....	19
3.4.5	Intended Users	20
3.4.6	Patient Group.....	20
4	Setup and Connection	21
4.1	Setup and Operating Conditions	21
4.2	Instructions for Setup and Connection.....	21
4.3	Patient Environment Information.....	22
4.4	Setup the Device.....	23
4.5	Electrical Connection.....	24
4.6	Switching On	25
4.7	Switching Off.....	25
4.8	Updating Software and/or Installation on Separate PCs	25
5	Pentacam® Program	26
5.1	Start Screen and Menu Bar.....	26
5.2	Scan Screen.....	27
5.3	Loading Existing Examinations.....	28
5.4	Direct Help	29
5.5	Information on Recording Scheimpflug Images	29
6	Measuring Procedure.....	30
6.1	Instructions for Operation.....	30
6.2	Preparations.....	31
6.3	Device Rough Adjustment	32
6.4	Darkening the Room.....	34
6.5	Fine Adjustment.....	34

6.6	CSP Pro Measurement.....	36
6.6.1	Quality Specification for CSP Pro Measurement.....	38
6.6.2	Repeat or Delete Measurement	39
6.7	Check the Quality (QA) of the Measurement and Detect Measurement Errors	42
6.8	Finish Measurement	44
7	Cleaning, Disinfection and Maintenance.....	45
7.1	Cleaning, Disinfection and Servicing Intervals	46
7.2	Consumables.....	46
7.3	Cleaning	46
7.3.1	Cleaning the Housing.....	47
7.3.2	Cleaning the Chin and Forehead Rests.....	47
7.3.3	Cleaning the Illuminated Slit.....	47
7.4	Disinfection	47
7.5	Attaching Paper to the Chin Rest.....	48
7.6	Conducting Test Measurements.....	48
8	Troubleshooting.....	49
9	Technical Data	50
10	Transport, Storage and Disposal	53
10.1	Disassembly	53
10.2	Storage Conditions	53
10.3	Transport Conditions	53
10.4	Transport and Shipping	54
10.5	Disposal.....	54
11	Warranty Terms and Service.....	55
11.1	Warranty Terms.....	55
11.2	Assumption of Liability for Functions and/or Damage.....	55
12	Appendices.....	56
12.1	Electromagnetic Compatibility (EMC).....	56
12.2	Guidance and Manufacturer’s Declaration: Electromagnetic Emissions and Immunity.....	57
12.3	Connection Diagram	61
12.4	Data Sheet for GSM90B24-P1M Power Adapter (10029038).....	62
12.5	Instructions for Integration into an IT Network.....	65

1 Scope of Delivery

Standard Components

Pentacam® Cornea OCT

- OCT measuring head
- OCT measuring box
- Ophthalmic table
- Chin-forehead-rest
- All-in-one PC
- Pentacam® basic software
- OCT epithel map
- User information

Optional Accessories

- Hard drive package
- external 4k monitor and PC
- NAS / DAS

Optional Software

- Cataract package
- Refractive package
- Screening package
- Contact lens package
- CSP Report Pro
- IOL calculator

We reserve the right to change the scope of delivery during the course of technical development.

- If you notice any transport damage on delivery, submit a complaint to the transport company immediately.
- Check the tilt indicator!



If the tip of the arrow is blue, the parcel has been tipped, tilted or transported lying down.

- Have the driver confirm the damage on the delivery note to ensure that proper claims can be settled.

You can find more information on transport in → chap. 9 "Technical Data" (page 50).

2 Safety Instructions

All safety-relevant instructions on the use of the device are only provided in the Instructions for Use for the device. This is why it is mandatory that you have fully read and understood the Instructions for Use prior to using the device.

- ➔ Please read the Instructions for Use carefully.
- ➔ Store the Instructions for Use carefully near the device.
- ➔ Observe the legally applicable accident prevention regulations.

2.1 Symbols

2.1.1 On the Device / Name Plate

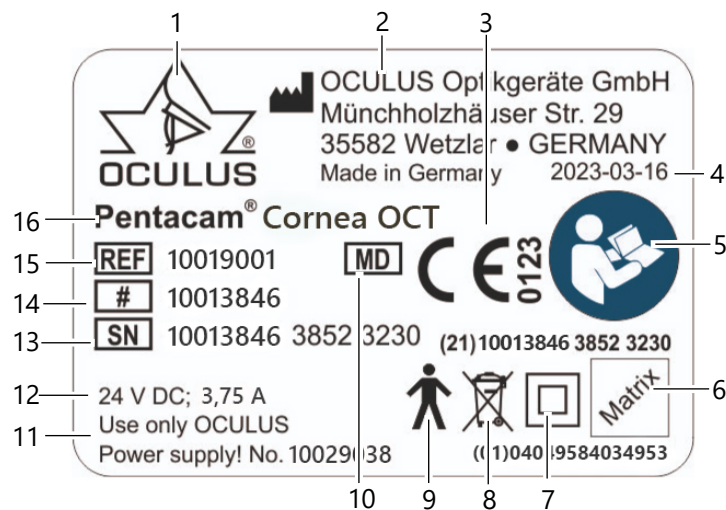











Fig. 1 Name plate (example)

No.	Description	No.	Description
1	Manufacturer logo	8	Do not dispose of in household trash
2	Name and address of the manufacture	9	Application part type B
3	CE mark and no. of notified body	10	Medical device
4	Date of manufacture	11	Power adapter details
5	Observe the Instructions for Use	12	Power supply
6	UDI number consisting of: top: UDI PI (production identifier) middle: machine-readable matrix code bottom: UDI DI (device identifier)	13	Serial number
		14	Model number
		15	Article number
7	Protection class	16	Device name

2.1.2 On the Packaging

Symbol	Description
	Protect from moisture
	Transport upright
	Fragile
	Do not stack
	Do not roll
	Protect from heat
	Permissible temperature range for transport
	Permissible temperature range for storage
	Permissible range for humidity
	Permissible range for air pressure

2.1.3 In this Manual



Warning

Identifies a potentially dangerous situation that may cause severe injuries.



Caution

Identifies a potentially dangerous situation that may cause minor injuries.



Note

Identifies situations that may cause damage to the device or result in false examination results.



Identifies important application instructions and important information about the product.

- > Menu paths are marked with >.
 - For example, to start a new examination:
Pentacam® > Examination > New
 - Which means:
 - ➔ Select the menu [Examination] from the menu bar.
 - ➔ Select the menu item [Scan].

[...] Menu items and buttons are shown in brackets

2.2 Safety Instructions for Use



Caution

Operating the device incorrectly may cause injuries to a person or damage the device.

- ➔ Observe and follow the safety instructions in this Instructions for Use.
-



Caution

Unapproved modifications to the device may cause injuries to a person or damage the device.

- ➔ This device and the corresponding lifting table must not be modified without the prior consent from the manufacturer.
 - ➔ Any changes or modifications must only be carried out by OCULUS Service and/or an authorized dealer.
-

Report any severe incidents that occur in connection with the product to the manufacturer (vigilance@oculus.de) and the competent authority of the Member State where you and/or your patient are located.

2.2.1 Instructions for the Operation of an ME System

The device and a connected computer form a medical electrical system (ME system) in accordance with IEC 60601-1. Any other device, such as a printer, that you connect will become a part of the ME system.

All devices belonging to the ME system must meet IEC 60601-1 or IEC 62368-1 requirements.

2.2.2 Instructions on Electrical Safety



Warning

Personal injury and/or property damage due to an incorrect level of safety

Connecting the device with non-medical electrical devices (such as data processing devices) to a medical electrical system must not result in a safety level for the patient that is less than IEC 60601-1. If as a result of this connection the leakage current threshold is exceeded, protective measures including a circuit breaker must be in place.

- Make sure that connections with non-medical devices are made correctly.
- Only use the power adapter listed in the scope of delivery.
- The computer used in connection with the device must meet the specifications that are listed in → chap. 9 "Technical Data" (page 50).



Warning

Personal injury and/or property damage due to unsafe multiple socket outlet

When using a multiple socket outlet to connect the device, observe the following instructions:

- Use the multiple socket outlet in accordance with IEC 60601-1, section 16 requirements.
- Do not place the multiple socket outlet on the floor.
- Use no more than one multiple socket outlet.
- Only use this multiple socket outlet to connect the device and, where applicable, the corresponding computer.
- When using a multiple socket outlet, it must be supplied with an isolating transformer.
- If using a new computer for the device, have the electrical safety inspected. Call OCULUS Service to do this.



Warning

Personal injury and/or property damage due to electromagnetic interference

Portable and mobile HF communication devices (high frequency) may interfere with medical electrical devices → chap. 2.2.1 "Instructions for the Operation of an ME System" (page 11).

- Make sure that portable and mobile HF communication devices are not causing any interference emissions.
- We recommend: Keep a minimum distance, please observe → chap. 12.1 "Electromagnetic Compatibility (EMC)" (page 56). If the distance is less, you must make sure that the device is working properly.

2.3 Instructions for Cybersecurity



Note

Please also follow the regulations, guidelines, and recommendations of the relevant authorities responsible for information security and the protection of critical infrastructure in your country.



The device is designed to operate independently without requiring an internet connection, network access, or portable media. It functions solely through a connected computer.

If you choose to connect the computer to the internet or another network for unrelated purposes, you are responsible for ensuring that the connection is secure and controlled.

2.3.1 Precautionary Measures against Unauthorized Access

To increase the cybersecurity of the device:

→ Secure the device against unauthorized access by unauthorized persons.

Observe all precautionary measures:

- Secure the computer with a strong password (e.g. during Windows startup).
- Choose a complex password of at least twelve characters that includes letters, numbers and special characters. Avoid dictionary words.
- Do not select a name or a device name as a password (such as "Pentacam").
- Change the default password after the first authentication.
- Change the password regularly.
- Do not write down the password at an accessible location.
- Use unique passwords for different user accounts.
- Do not share user names or passwords with colleagues or anyone else, even if authorized by law and employer policy to view the same type of information (e.g. two users reviewing the same patient samples).
- Enable a screen saver that requires re-entry of the password upon deactivation.
- Set an appropriate screen saver timeout (e.g. 10 minutes) based on operational conditions such as examination duration and patient flow.
- Ensure that the device is locked (keyboard shortcut: Windows logo button + 'L') or otherwise secured when not in use to prevent unauthorized access to electronic Protected Health Information (ePHI).
- Operators are required to be trained according to privacy awareness and handling personal data.
- If necessary, contact your Healthcare Organization's IT Department.

2.3.2 Precautionary Measures if the Computer is Connected to a Local or Internet Network

- Do not establish an internet connection while using the device. This is considered misuse!
- If you connect the computer to the internet for any other purpose, you are responsible for ensuring data security.

If you connect your computer to a local network, you are responsible for ensuring data security and must observe at least the following precautionary measures:

- Preferably connect the computer to the network using a cable connection over wireless connection.
- Use robust security methods incl. advanced Encryption Standards with a strong network key also for wired connections (not only for Wi-Fi connections).
- Use of a firewall (software or hardware) is recommended.
- Observe the instructions for integration into an IT network → chap. 12.5 "Instructions for Integration into an IT Network" (page 65).



Note

The Healthcare Organization's IT Department should implement a risk management framework in alignment with IEC 80001-1 to support the secure and safe integration of medical IT networks. This includes assessing risks, enforcing access control, securing networks, applying software updates, monitoring incidents, protecting data, managing device life cycles, and training staff to help safeguard patient safety and data integrity.

The Manufacturer Disclosure Statement for Medical Device Security (MDS2) is available upon request for detailed security information.

2.3.3 Device Security

- ➔ Ensure that the device is secured against unauthorized access → chap. 2.3.1 "Precautionary Measures against Unauthorized Access" (page 13).
- ➔ Protect the device and attached systems from malicious software.
- ➔ Implement new software versions when available.
- ➔ Implement operators access only on a need-to-know-basis.

The Healthcare Organization's IT Department is responsible for implementing controls for the handling and disposal of media and assets.

2.3.4 Data Responsibility

Operators should avoid entering unnecessary identifying data. Whenever possible, data should be de-identified and linked to the sample ID instead of the patient. Use only the input data essential for the intended purpose.

Operators have access to sensitive patient data (ePHI).

- ➔ Do not take any snapshots, screenshots, or images (e.g. using another device) of the information displayed on the device.

Data shall be deleted on a regular basis according to the Healthcare Organization's deletion policy, if respective data are processed by the device.

The Healthcare Organization's IT Department is responsible for deleting unused user accounts.

Only authorized personal is allowed to take backups. The Healthcare Organization's IT Department shall manage the location of each backup in order to respond to potential data subject requests. Backups and archive files are required to be transmitted and stored securely.

2.3.5 Reporting and Handling of Security Incidents

Operators must inform their Healthcare Organization's IT Department about any suspected or confirmed privacy or security breaches, including suspected or compromised user accounts, and report any service outages or access issues.

If accounts are deemed compromised, devices are lost, or unauthorized access has been discovered or assumed, the Healthcare Organization's IT Department locks or changes the user login criteria and issues new login information so that the user can safely access his or her account.

3 Device Description

3.1 Device Components

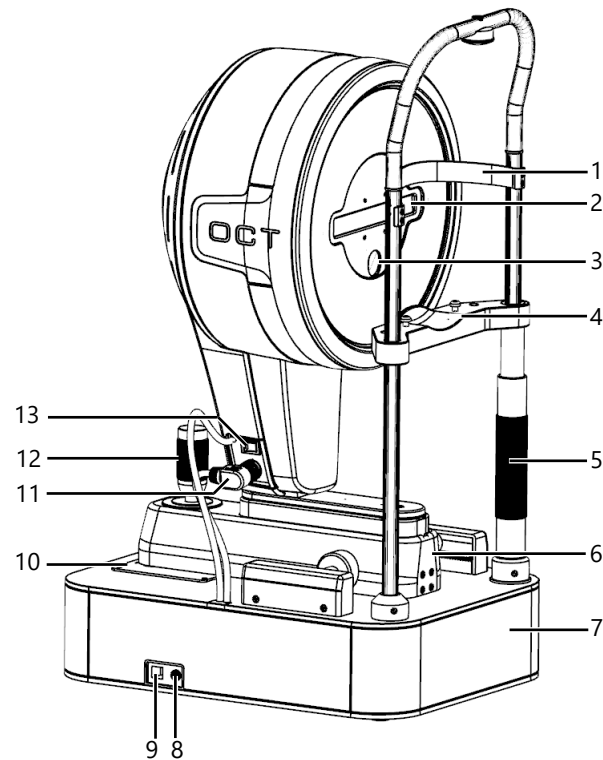
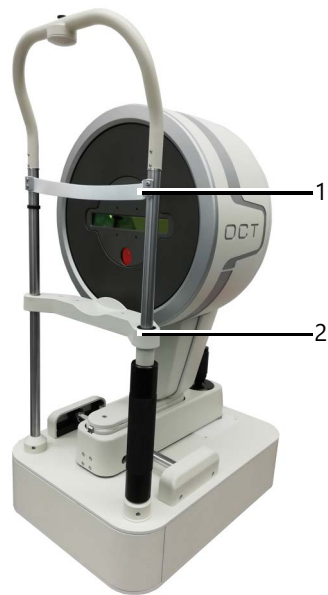

Fig. 2 Device components

No.	Description
1	Forehead rest
2	Iris camera with blue slit lamp
3	Scheimpflug camera
4	Chin rest
5	Twist grip
6	Cross slide
7	Basis
8	Mains connection
9	USB port
10	Sliding plate with circle marks
11	Plug
12	Joystick
13	On/off switch with indicator lamp

3.2 Applied Parts



No.	Description
1	Forehead rest
2	Chin rest

Fig. 3 Applied parts

The chin and forehead rests are Type B applied parts.

3.3 Principle of Operation

While rotating around the eye, the device captures Scheimpflug images of the anterior eye segment through varying axes. The Scheimpflug images created during an examination are transmitted to the connected PC. Scheimpflug images are captured within two seconds. Up to 138000 (optional up to 276000) genuine height values are measured and analyzed from the Scheimpflug images. The Scheimpflug images are the basis for the height data which are used to calculate a mathematical 3D model of the anterior eye segment. At same time any eye movements are recorded and taken into account. A quality specification (QS) indicates the quality of the measurement taken. The mathematical 3D model, corrected for eye movements, provides the basis for all subsequent analysis. The tomography of the front and back surfaces of the cornea, the pachymetry and the densitometry are calculated and displayed from limbus to limbus for the entire surface of the cornea. A geometric analysis of the anterior chamber provides the basis for calculating the chamber angle, chamber volume and chamber depth. Densitometry of the cornea and lens automatically produces quantified values. Color images displayed on the screen show the results of the measurement. A rotatable 3D model displays the front and back surfaces of the cornea, the iris and the lens.

The OCT systems creates images (tomograms) simultaneously with the Scheimpflug system while rotating around the eye. The spectral domain optical coherence tomography system captures signals by several scans. For this purpose, broadband light, which has a short coherence length, is split into two partial beams using a beam splitter. One partial beam is directed onto the sample (cornea), the other partial beam passes through a reference path. The light reflected from the sample is superimposed on the reference light, creating interference patterns which are acquired by a spectrometer. Different structures along the optical axis (depth) can then be distinguished by their characteristic spectral interference patterns. The computer software then creates images from the OCT scan data, visualizes and analyzes the images to generate maps and measurement values. Three-dimensional images are obtained by scanning laterally over the sample through varying axes.



OCULUS Optikgeräte GmbH is by no means responsible for further use of the data recorded with the device and for the valuations it has calculated.

3.4 Intended Purpose



The Pentacam® Cornea OCT is intended exclusively for the use specified in this manual and in compliance with the safety instructions.

3.4.1 Intended Use

The Pentacam® Cornea OCT is designed to take photos of the anterior segment of the eye using both, Scheimpflug and OCT imaging methods. Scheimpflug images are obtained using a digital CMOS camera with slit lamp illumination. Images include the cornea, pupil, anterior chamber and lens of the eye and are used to evaluate:

- corneal shape,
- analyze condition of the lens (opaque crystalline lens),
- analyze the anterior chamber angle,
- analyze the anterior chamber depth,
- analyze the volume of the anterior chamber,
- analyze anterior and posterior cortical opacity,
- analyze the location of cataracts (nuclear, sub capsular and/or cortical), using cross slit images with densitometry,
- corneal thickness,
- white-to-white-distance.

The OCT component of the system uses broadband Multi-SLD and is intended for the in vivo imaging, cross-sectional, and the three-dimensional imaging and measurement of corneal epithelium.

3.4.2 Intended Medical Indication

The Pentacam® Cornea OCT is indicated for use as a diagnostic device to aid in the detection and management of ocular diseases affecting the anterior segment of the eye.

3.4.3 Contraindication

None known

3.4.4 Possible Side Effects

None known

3.4.5 Intended Users

The Pentacam® Cornea OCT is intended exclusively for professional use:

- In Eye specialists practices
- In Clinics
- At optician or optometrist shops

The Pentacam® Cornea OCT is intended for use by trained staff:

- Who, based on their knowledge, training and practical experience, can ensure professional handling.
- Who have been instructed by OCVLUS personnel or an authorized dealer prior to putting the device into operation.

3.4.6 Patient Group

- Adults 22 years and older.
- No restrictions on weight, health and condition.
- The patient is awake.
- The patient is able to understand and to look into a fixation target.

4 Setup and Connection

4.1 Setup and Operating Conditions

Temperature	+10 °C to +35 °C
Humidity	30% to 90%
Air pressure	800hPa to 1060hPa

- Before installation, compare the transport and storage temperature with the temperature in the intended installation room.
- The difference between the transport and storage temperature and the installation room should not be more than 10 °C to prevent the internal optics from misting up.

4.2 Instructions for Setup and Connection

- The device must only be set up and connected by OCULUS or an authorized dealer.
- Do not use the device in moist locations and never set the device down there.
- Avoid areas dripping, splashing or spraying water near the device and make sure that no liquid can penetrate the device.
Do not place any containers filled with liquids near the device.
- Only operate the device in rooms used for medical purposes provided they have been set up in accordance with VDE regulations 0100-710.
- Do not operate the devices included in the scope of delivery in explosive areas, or in proximity to flammable anesthetics or volatile substances such as alcohol, benzene or similar products.
- Set up the device so that the power plug can be easily accessed. This way, you can easily disconnect it from the power supply for any repairs.
- Do not apply excessive force when connecting electrical plug connections.
- If you are unable to make a connection, check whether the plug fits the socket.
- If you detect damage to the plug connection, have our service repair the damage.
- Only use a device that is properly mounted to a suitable lifting table.

4.3 Patient Environment Information

The patient environment is the area in which patients may come into contact with any part of the system or where the patient may come into contact with another person that was in contact with the system.

- ➔ Only use devices in the patient environment that conform to IEC 60601-1.

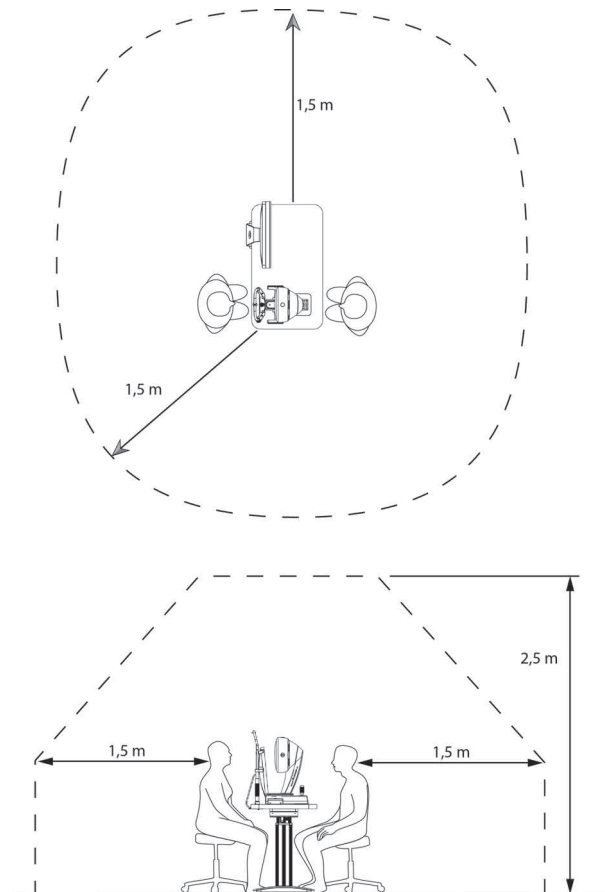

Fig. 4 Patient environment

4.4 Setup the Device



Note

Improper setup may cause faulty measurements or even damage to the device.

- Have the OCULUS Service or an authorized specialist set up and connect the device.
 - Set up the device so that it cannot fall over. Mount the device onto an examination table.
 - Set up the device in such a way to ensure that it is protected from dripping, splashing, or spraying water.
-



Note

Risk of device damage due to improper handling of the device

- Do not subject the device to any vibrations, shocks, contaminants, moisture, or high temperatures.
 - Handle the device with care.
-

- Set up the device so that the power plug can be easily accessed. This way, you can easily disconnect the device it from the power supply for any repairs.
- Position the device to ensure that no direct light can affect the measurement.
- Select the setup location so that the examination is free of light reflections.
- You should be able to darken the examination room.

4.5 Electrical Connection



The difference between the temperature of the installation room and the storage and transport temperature should not be more than 10 °C to avoid fogging of the internal optics.

- Allow the device to stand unused for at least 6 hours in the installation room before connecting it so that the device can adapt to the ambient temperature.



Warning

Electrical safety may be compromised if the following instructions are not observed:

- Do not use the Pentacam® in the direct proximity of other devices.
- Do not stack the Pentacam® with other devices.
- Only use the power adapter supplied or one that is identical to the one listed in the scope of delivery → chap. 1 "Scope of Delivery" (page 7).
- Do not place any heavy objects or the device itself on the power cord.
- When using a multiple socket outlet to connect the device, the multiple socket outlet must meet IEC 60601-1 requirements.
- Do not place the multiple socket outlet on the floor.
- Do not subject the power cord or the multiple socket outlet to high temperatures. Do not place them on heating units!
- Use no more than one multiple socket outlet.
- Only use this multiple socket outlet to connect the device and, where applicable, the corresponding computer.
- Use a socket outlet that has a flawless protective conductor connection.



No.	Description
1	On/off switch
2	Y-cable plug

Fig. 5 Connect and switch on



Note

If the device is not properly connected and is live, the device may be damaged after a short period of time.

- Do not apply excessive force when connecting electrical plug connections.
- Observe the information on the nameplate.
- If the plug is defective, contact OCULUS Service or an authorized dealer to alleviate the damage.

1. Where applicable, connect the USB-cable to the computer/laptop.
2. Plug the power adapter plug into the socket outlet. Make sure that the plug is completely inserted into the socket outlet.

4.6 Switching On



Note

Faulty measurements if the device is not ready for operation

- ➔ Make sure that the device is switched on for at least an hour before taking measurements.
-

1. Switch the PC or laptop on.
2. Switch the device on from the on/off switch.
The LED on the on/off switch is illuminated green.

4.7 Switching Off

1. Close the Pentacam® program and Patient Data Management.
2. Shut down the Windows operating system.
3. Switch the device off from the on/off switch.

4.8 Updating Software and/or Installation on Separate PCs

The Pentacam® software is network compatible, which means the Pentacam® software can be installed on separate PCs that are connected on a local network. The Floating License Key is supplied with each device.



The software and any software updates may only be installed by OCULUS Service and/or an authorized dealer.
The latest version of the software is already installed upon delivery.

The same Pentacam® software version should be installed on all PCs on a network. This allows you to interactively and simultaneously evaluate Pentacam® examinations based on the activated, optional packages and modules. You can view the supplied demo examinations on every PC on which the Pentacam® software is installed.
For more information, contact OCULUS Service and/or an authorized dealer.

5 Pentacam® Program

The device is definitely ready for use if no error message is displayed after starting the software with the device connected and switched on.

5.1 Start Screen and Menu Bar

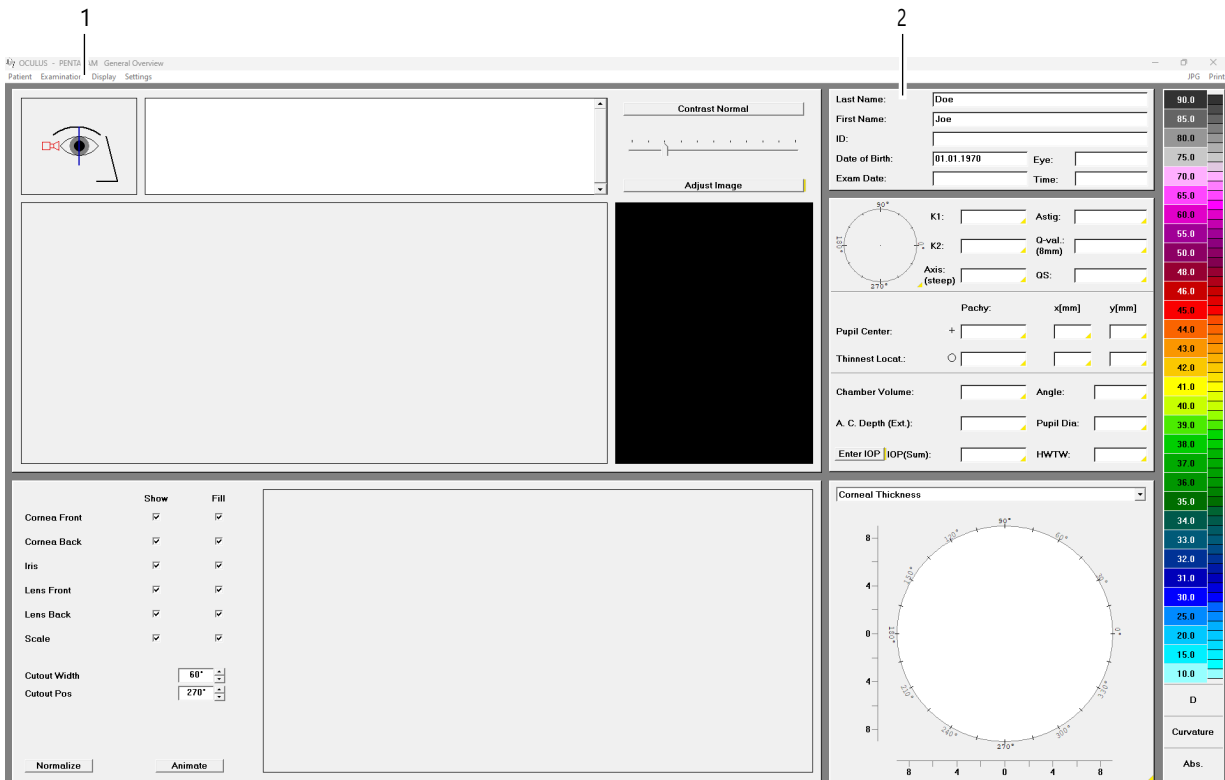

Fig. 6 Start screen: Overview

No.	Description
1	Menu bar
2	Examination and patient data



The Pentacam® software is not intended to prescribe potential therapies without any further professional examination or additional medical findings or diagnostic tests.

5.2 Scan Screen

Menu [Examination] > Scan

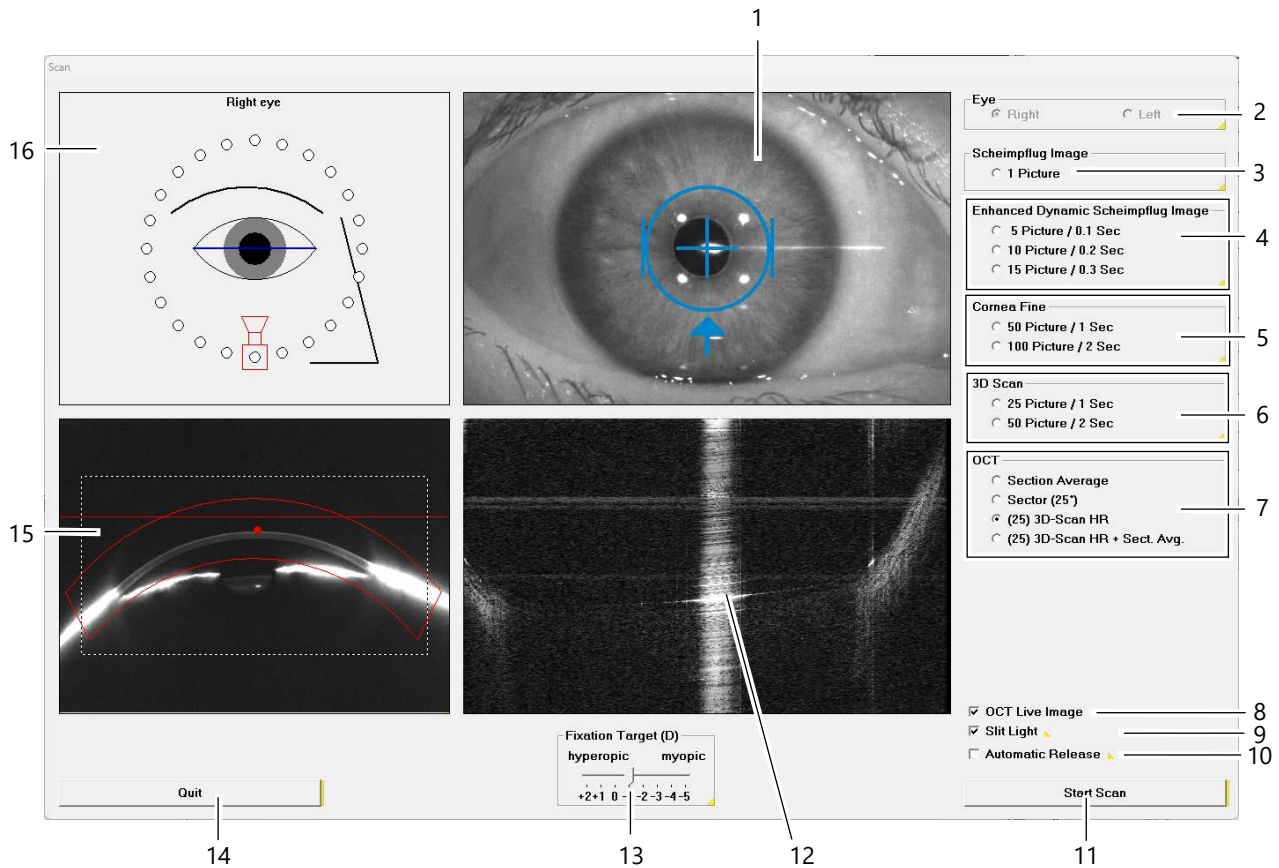

Fig. 7 "Scan" screen

No.	Field	Description
1	Adjustment window with pupil image	shows a live image of the subject's eye and uses the arrows shown to indicate where the device must be moved with the joystick in order to trigger the automatic measurement. The yellow dot marks the apex of the cornea. It must be positioned in the center of the crosshairs. The blue dot marks the center of the pupil. The blue ring marks the pupil.
2	"Eye"	The eye (right / left) is usually automatically recognized and activated here. If not, it can be selected manually.
3	"Scheimpflug Image"	If this option is activated only one Scheimpflug image is recorded. You can freely select the required camera position by clicking on the white ring in the "Orientation" field.
4	"Enhanced Dynamic Scheimpflug Image"	This option provides the ability to record either 5 , 10 or 15 Scheimpflug images from one camera position. The recorded images are averaged to minimize background noise. Only one Scheimpflug image is displayed. You can freely select the required camera position by clicking on the white ring in the "Orientation" field. This type of image is suitable for purely densitometric assessment of the lens.

No.	Field	Description
5	"Cornea Fine"	3D scan with 50 or 100 cross-sectional images (instead of the normal 25 cross-sectional images)
6	"3D Scan"	You can select here how many images per scan you want to record. The difference is in the duration of the examination and the number of measuring points evaluated. So, a scan with 50 images takes longer, but achieves the highest accuracy with good fixation of the patient. This type of examination is used to evaluate the cornea and the anterior chamber.
7	"OCT"	<p>Section Average: Overlaying several images into one (averaging) in order to achieve a high display quality in the selected orientation.</p> <p>Sector (25°): 1 sector can be specifically selected, from which images are then taken in 1° increments.</p> <p>(25) 3D-Scan HR: The device rotates around the eye during the recording and takes 25 images in different axes. An OCT image (sectional image) is created for each image.</p> <p>(25) 3D-Scan HR + Sect. Avg.: Combination of 3D scan + 5 sectional images (OCT), which are averaged in the horizontal axis (180°).</p>
8	Checkbox [OCT Live Image]	Show / do not show live sectional image
9	Checkbox [slit light]	Switch the eye illumination on or off with the blue light
10	Checkbox [automatic release]	Activate/deactivate automatic measurement release
11	Button [Start scan]	For manual release is while the checkbox is deactivated [automatic release]. Alternatively, you can use the return key.
12	OCT Image	If the [OCT Live Image] checkbox is activated, an image will be displayed here.
13	Fixation target	Red flashing LED in the center of the blue slit The "Fixation target" enables you to better fixate the patient. For this purpose, the active "Fixation target", the red flashing LED can be moved in the center of the blue slit in 0.5 dpt steps. The objective is to offset defects in the patient's vision and ensure an easier method of fixation.
13	Button [Quit]	Cancel current measurement
14	Current Scheimpflug image	Indicates the distance of the device to the patient. The goal of the setting is to bring the red dot on the corneal anterior surface onto the red line.
15	"Orientation" field	Informs about the current camera position and which eye is measured

5.3 Loading Existing Examinations

1. Select [Examination] and click on [Load].
The "Load examination" dialog opens.
2. Highlight to the required examination.
3. Confirm by clicking on [OK] or by double clicking.
The required examination is loaded in the Pentacam® program.

5.4 Direct Help

The Pentacam® program features a direct help option. You can recognize it based on the small yellow mark next to the texts, buttons, etc.

Examples:



→ Open direct help by clicking on the yellow mark.

5.5 Information on Recording Scheimpflug Images

Examination goals	Examination mode	Images	Trigger measurement automatically	Notes
Topography	3D scan	25 – 50	Yes	
Pachymetry	3D scan	25 – 50	Yes	
Anterior chamber analysis	3D scan	25 – 50	Yes	Do not dilate eye with drops!
Artificial lens general	Enhanced Dynamic (For HR with examination mode 3D scan)	15	Yes	If the pupil is insufficiently dilated, apply mydriatic drops. Use 3D scan for measurements.
Measurement functions	3D scan	25 – 50	Yes	If the pupil is insufficiently dilated, apply mydriatic drops.
Densitometry	3D scan Enhanced Dynamic	25 – 50 5 – 15	No	Use the same number of images to enable a progress check and apply mydriatic drops.

6 Measuring Procedure

**Note**

Improper setup may cause faulty measurements.

- Before first-time use: Allow OCULUS or an authorized dealer instruct you in the operation of the device.

**Note**

Faulty measurements if the device is not ready for operation.

- The device must have been switched on for at least an hour before taking measurements.

**Note**

Faulty measurements caused by slight movements by the patient

Slight movements that may occur naturally may cause the patient to no longer be positioned adequately to the device.

- Only take measurements with the device if the patient is seated in a stationary chair. If the patient is seated in a rolling chair, lock the brake.



The Instructions for Use focuses on the operating concept of the device. The functional description of the Pentacam® program is limited to initiating a measurement and loading existing examinations.

You can find more detailed information on the functions of the Pentacam® program in the User Guide.

6.1 Instructions for Operation

- Before first-time use: Allow OCULUS or an authorized dealer instruct you in the operation of the device.
- Never put a damaged device into operation.
- Only operate the device using the original accessories supplied by us and only if in perfect technical condition. Use the power adapter listed in the scope of delivery only.
- Do not touch the patient and the device at the same time.
- Make sure that the device cannot tip over by leaning against it or sitting on it.
- Do not place the device including battery or cable on heat-generating devices (e.g. radiators, microwaves or similar).
- Only operate the device if you have fully understood the instructions for use.

Note

ISO 15004-2:2007 Group 2 instrument

A graph showing the relative spectral output of the instrument between 305 nm and 1100 nm when the instrument is operating at maximum light intensity and maximum aperture will be provided by OCULUS on request. The spectral output will be shown for the beam after it exits the instrument.

Caution

The light emitted from this instrument is potentially hazardous. The longer the duration of exposure and the greater the number of pulses, the greater the risk of ocular damage. Exposure to light from this instrument when operated at maximum output will exceed the safety guideline after 9341 seconds.

For US:

Caution

The light emitted from this instrument is potentially hazardous. The longer the duration of exposure, the greater is the risk of ocular damage. Exposure to light from this instrument when operated at maximum intensity will exceed the recommended maximum exposure (RME) of 2.2 J/cm², unless additional action is taken by the user to minimize exposure, after 2055 seconds (per patient eye).

6.2 Preparations

1. Start the Scan menu → chap. 5.2 “Scan Screen” (page 27) by selecting on the menu item [Examination] and clicking on [Scan]. The blue slit light is activated and the scan menu opens.
2. If necessary, change the recording options for the part of the anterior eye segment to be examined. By default, the “3D scan” options are preset with “25 images/second”.
3. Adjust the table height.
4. Check whether
 - Fresh paper has been placed on the chin rest or the chin rest has been cleaned or disinfected
 - The forehead rest has been cleaned and disinfected.
5. Ask the patient to place his/her head in the chin and forehead rests.
 - Do not touch the patient and the device at the same time!

6.3 Device Rough Adjustment



Fig. 8 Positioning the patient (example device)

No.	Description
1	Black ring for orientation of the eye level
2	Twist grip for adjusting the height of the chin rest

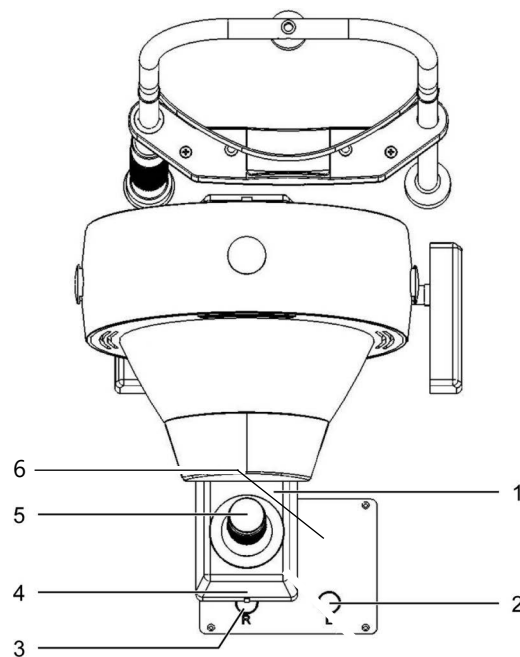

No.	Description
1	Cross slide
2	'L' left circle mark
3	'R' right circle mark
4	Mark on the cross slide
5	Joystick
6	Sliding plate

Fig. 9 Parts for positioning the device (example device)

6. Use the twist grip to adjust the height of the chin rest.
The patient is seated properly if the forehead and chin touch the rests and the eye are at the height of the mark (black ring).
7. To roughly adjust (example for the right eye), move the cross slide until the mark at the end of the cross slide roughly coincides with the circle mark 'R' on the sliding plate.
8. Look at the patient's eye you are examining from one side and make sure that the blue slit light illuminates the cornea → fig. 10 (page 33).
9. If necessary, adjust the position of the cross slide to the left or right.

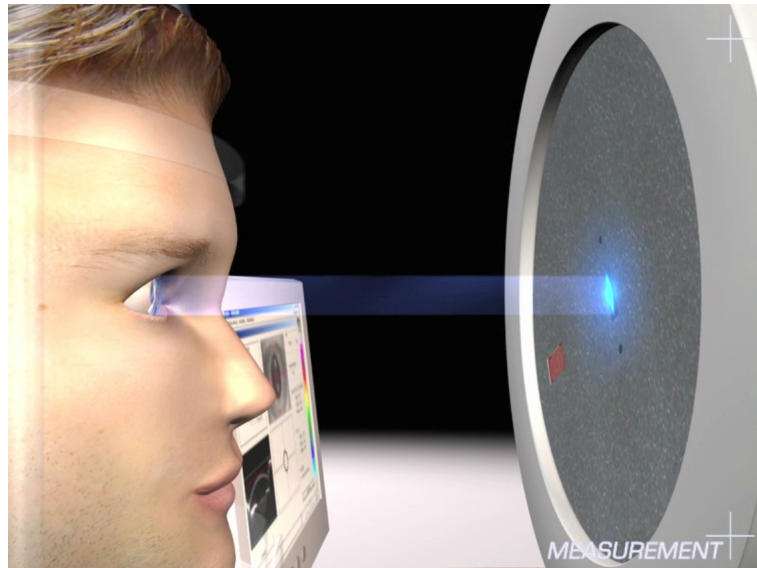

Fig. 10 Slit light on the cornea



If no blue slit light is visible, check to see if the checkbox [slit light] is activated on the "Scan" screen.

6.4 Darkening the Room

10. Darken the room.

If the lighting in the examination room cannot be switched off or the room cannot be darkened, use the dark sheet supplied to cover the patient and the device.



Fig. 11 Patient and device with dark sheet

6.5 Fine Adjustment

11. Make the settings for the desired Measurement in the scan screen, refer → chap. 5.2 "Scan Screen" (page 27).

12. Move the cross slide towards the patient until the cornea of the eye you are examining can be seen in the Scheimpflug image

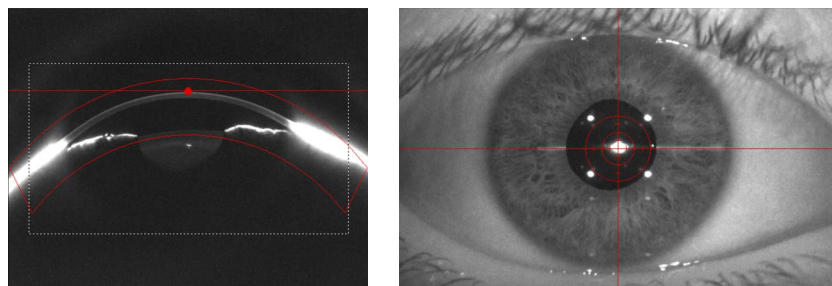

Fig. 12 Scheimpflug image (left) and pupil image (right)

The image is sharpest when the red dot coincides with the red line in the Scheimpflug image.

13. Focus the pupil image by moving the joystick in the direction of the device or away from the device.

14. Correct the left/right position of the device and the height adjustment as well. To do so, move the joystick to the left or right and turn the handle of the joystick clockwise or counterclockwise.

The preliminary final position is reached once the yellow dot is positioned in the center of the crosshairs.

15. Ask the patient to widen his/her eye and to not blink.

16. Move or turn the joystick for the fine adjustment in the direction specified by the arrows.

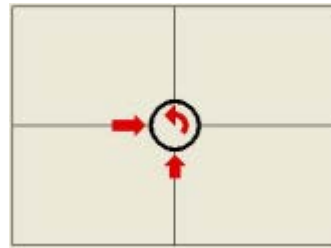

Arrow	Moving the camera	Joystick movement
	Right	Push the joystick to the right
	Left	Push the joystick to the left
	Forward	Push the joystick towards the patient
	Back	Push the joystick away from the patient
	Top	Turn the joystick clockwise
	Bottom	Turn the joystick counterclockwise

17. As soon as the position is sufficiently accurate, a cross appears in the center of the ring that is surrounded by four bars. The device triggers the measurement automatically.

→ Press the icon [Scan] or the return key to manually trigger the measurement.



In some cases, a manually triggered measurement cannot be reproduced.

18. Ask the patient to remove his/her head from the chin and forehead rests.

19. Check the measuring results based on the quality specifications, refer → chap. 6.7 "Check the Quality (QA) of the Measurement and Detect Measurement Errors" (page 42).

6.6 CSP Pro Measurement

In a CSP Pro measurement, not only the cornea, but also parts of the sclera are measured. This means larger diameter contact lenses such as scleral lenses can be fitted.

Before the Measurement

By default, always a tomography measurement is carried out → chap. 6 (page 30). To carry out a CSP Pro measurement, proceed as follows:

1. Move the CSP Pro slider to the right position to activate the CSP Pro measurement.
The "Tomography" entry is hidden and the "CSP Pro" entry is displayed instead.
2. Make sure that the [Automatic Release] checkbox is selected.
3. Prepare the measurement and adjust the patient.

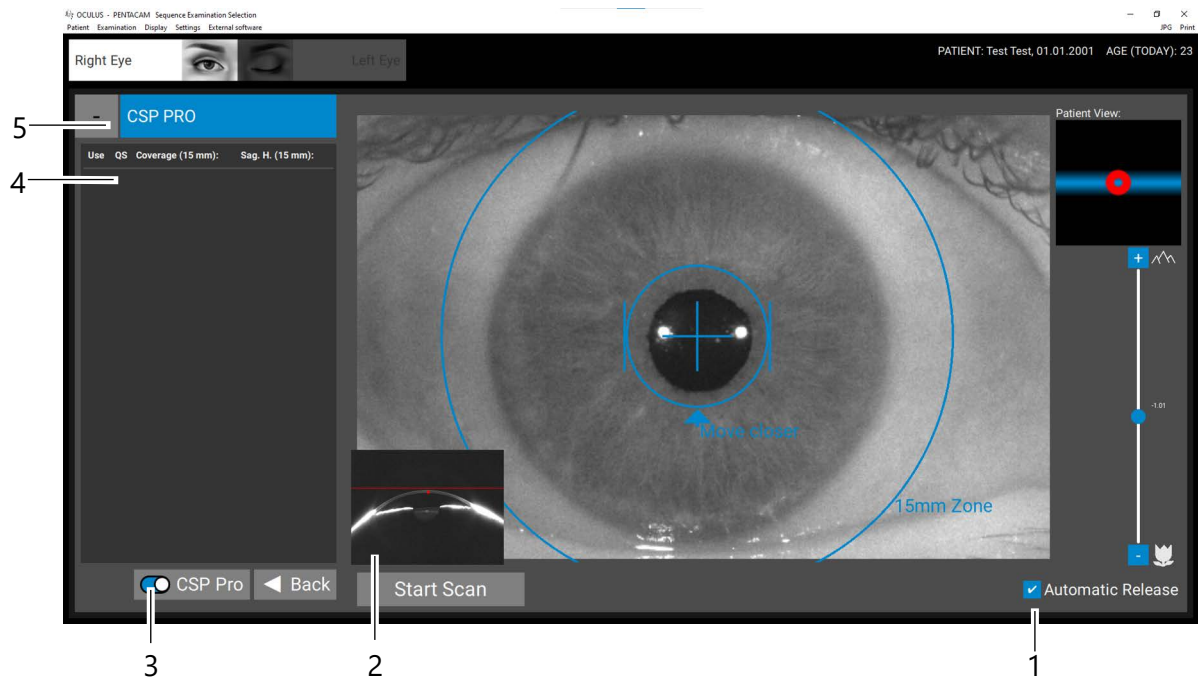

Fig. 6-1: "CSP Pro" examination screen

No.	Description
1	[Automatic Release] checkbox
2	Live Scheimpflug image
3	CSP Pro slider
4	Tomography parameter
5	Current examination mode

Perform Measurement

4. Move the cross slide towards the patient until the live Scheimpflug image shows the cornea of the eye that you are examining

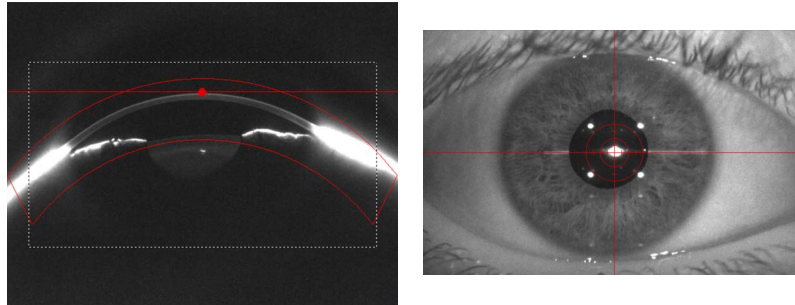

Fig. 6-2: Scheimpflug image (left) and overview image (right)

The image is sharpest when the red dot coincides with the red line in the Scheimpflug image.

5. Focus the pupil image by moving the joystick back and forth.
6. Ask the patient to widen his or her eye and not to blink.
7. Follow the instructions on the scan screen and adjust the left/right position of the Pentacam[®] Cornea OCT and its height setting.
Move the joystick to the left or right and rotate the joystick clockwise or anticlockwise.
The tentative final position of the camera is reached when the four bars frame the blue circle.
The Pentacam[®] Cornea OCT triggers the measurement automatically.
8. Ask the patient to remove his or her head from the rest.
9. Check the measurement results by referring to the quality specifications → chap. 6.6.1 (page 38).

6.6.1 Quality Specification for CSP Pro Measurement

After measuring either automatically or manually, the Pentacam® program opens. The “QS” value appears in a field.

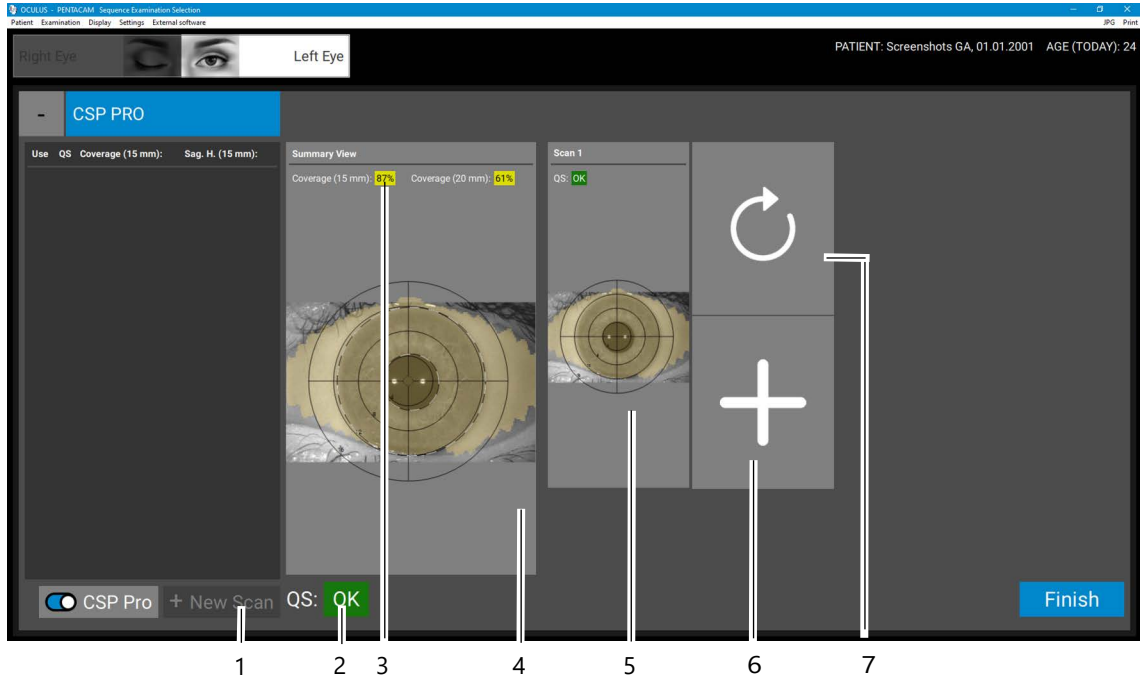

Fig. 6-3: Results display for a CSP Pro measurement

No.	Description
1	[+New Scan] button
2	“QS” value green / OK = measurement is correct and can be reproduced yellow = measurement not optimal; ideally repeat measurement red = no usable measurement; repeat the measurement
3	Value for the overall coverage
4	Display sum of all individual measurements
5	Individual measurements
6	[Add measurement] button
7	[Repeat measurement] button



All examinations are automatically saved, regardless of the quality of the measurement taken.

If an error message is displayed in the “QS” field, the measurement must be repeated.

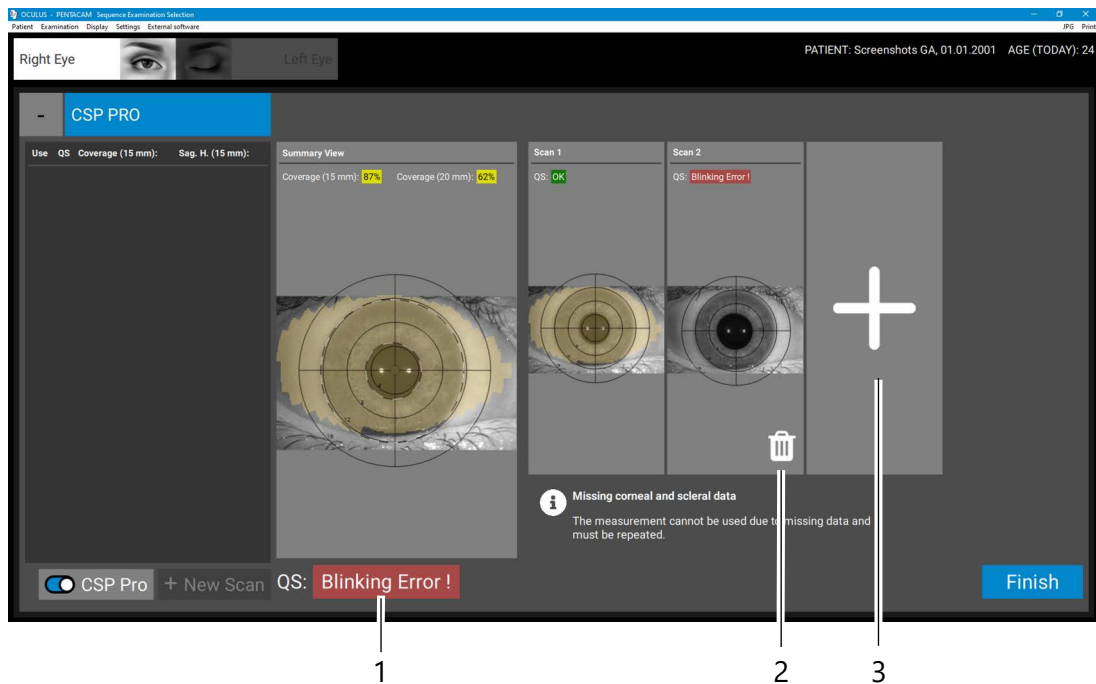

Fig. 6-4: Error message after a CSP Pro measurement

No.	Description
1	Error message
2	[Delete measurement] button
3	[Add measurement] button

6.6.2 Repeat or Delete Measurement

If the QS value of the first measurement is not sufficient to use this for evaluation, repeat the measurement:

1. Click on the [Repeat measurement] button.
The measurement is repeated and the previous measured values automatically get deleted.



The eye needs to be held open wide enough for the desired measurement area not to be covered by the eyelids to achieve good coverage of the cornea and sclera. We recommend holding up the upper eyelid with the LidStick® or alternatively a long cotton swab. The patient can carefully pull down his or her lower eyelid with a finger.

2. Click the [Add measurement] button to the right of the last measurement taken to add a measurement.
The coverage area of each measurement is shown in a different color in the corresponding display.
The coverage of all individual measurements is displayed summed up in the coverage map.

3. Carry out additional examinations until the required measurement area is achieved i.e. a complete corneal scleral profile.
4. If necessary, delete measurements with yellow or red QS.
This is also necessary if more than 4 individual measurements have to be carried out in order to obtain coverage > 95%.

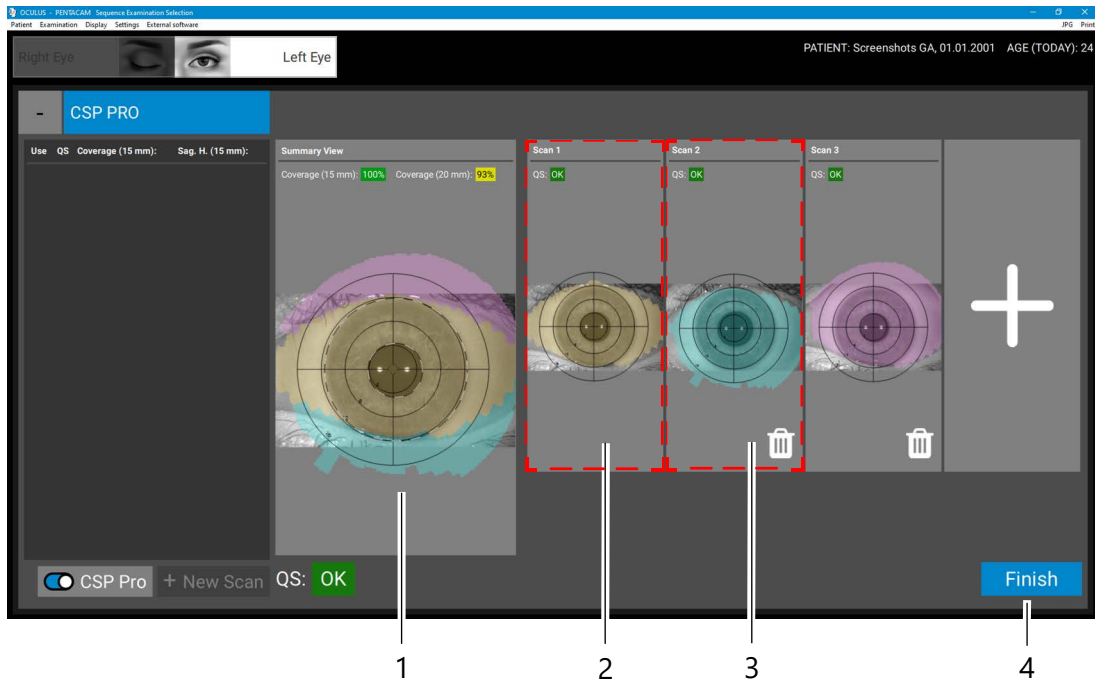

Fig. 6-5: Coverages of individual measurements and total coverage

No.	Description
1	Coverage areas of the single measurements Scan 1, Scan 2 and Scan 3 superimposed
2	Single measurement scan 1
3	Single measurement scan 2
4	[Finish] button

5. Click the [Finish] button to complete the CSP Pro measurement.

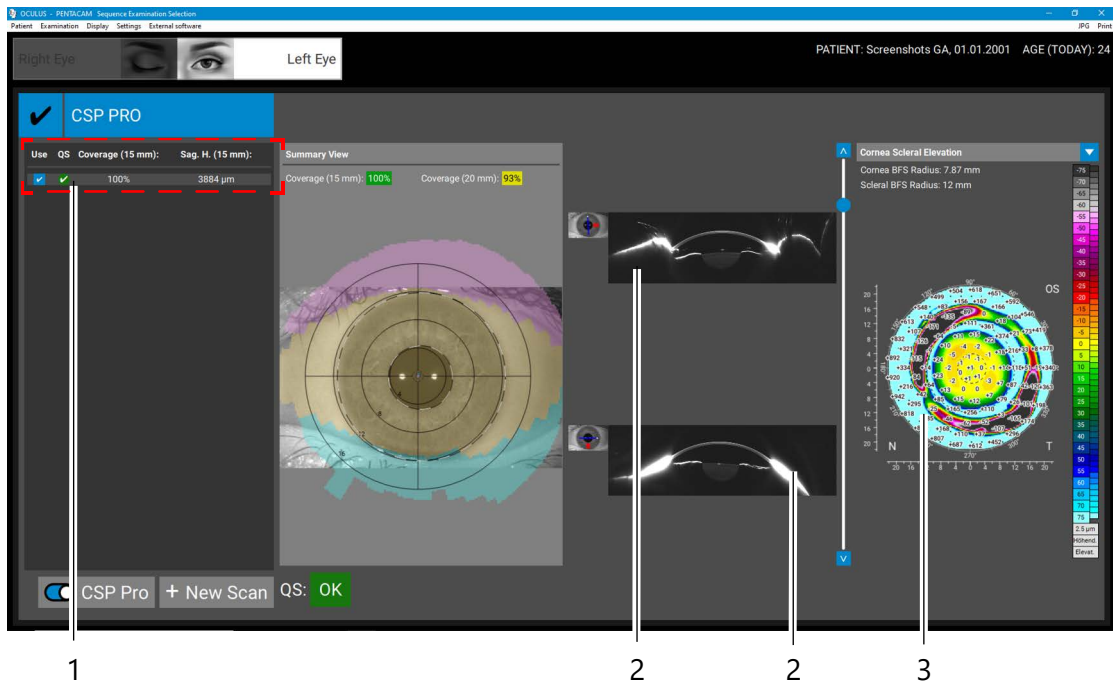

Fig. 6-6: Completed CSP Pro measurement

No.	Description	
1	Parameters of the CSP Pro measurement	<ul style="list-style-type: none"> ■ Use: Examination can be used for the evaluation. Click the checkbox of the respective measurement to use it for the evaluation. ■ Use only one measurement for the full sequence examination. ■ QS: Quality specifications → chap. 6.6.1 (page 38). ■ Coverage (15 mm): Coverage of the cornea and sclera in percent. ■ Sag. H. (15 mm): Sagittal height of the cornea for a diameter of 15 mm.
2	Scheimpflug images	
3	Elevation map	

6.7 Check the Quality (QA) of the Measurement and Detect Measurement Errors

The evaluation via the “QA” field helps to evaluate the quality of the measurement performed and to detect errors in the measurement process.

The “General Overview” screen opens automatically after a measurement. Clicking on the “QA” field opens the quality specifications.

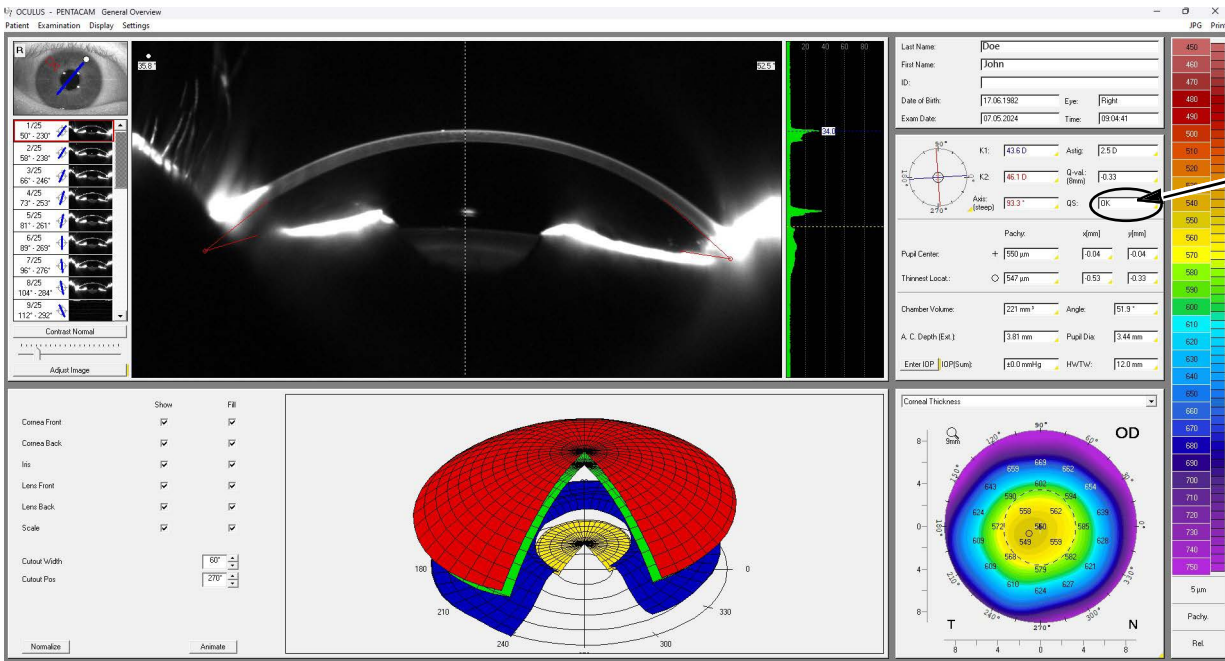

Fig. 13 “QS” field in ‘General Overview’

QS field	Meaning
OK	Measurement is correct and can be reproduced
red	Repeat the measurement
yellow	Measurement not optimal: check measurement results!

Alternatively, you can call up the “OCT Images” overview screen. The evaluation is also carried out here via the “QA” field.

Display > OCT Images

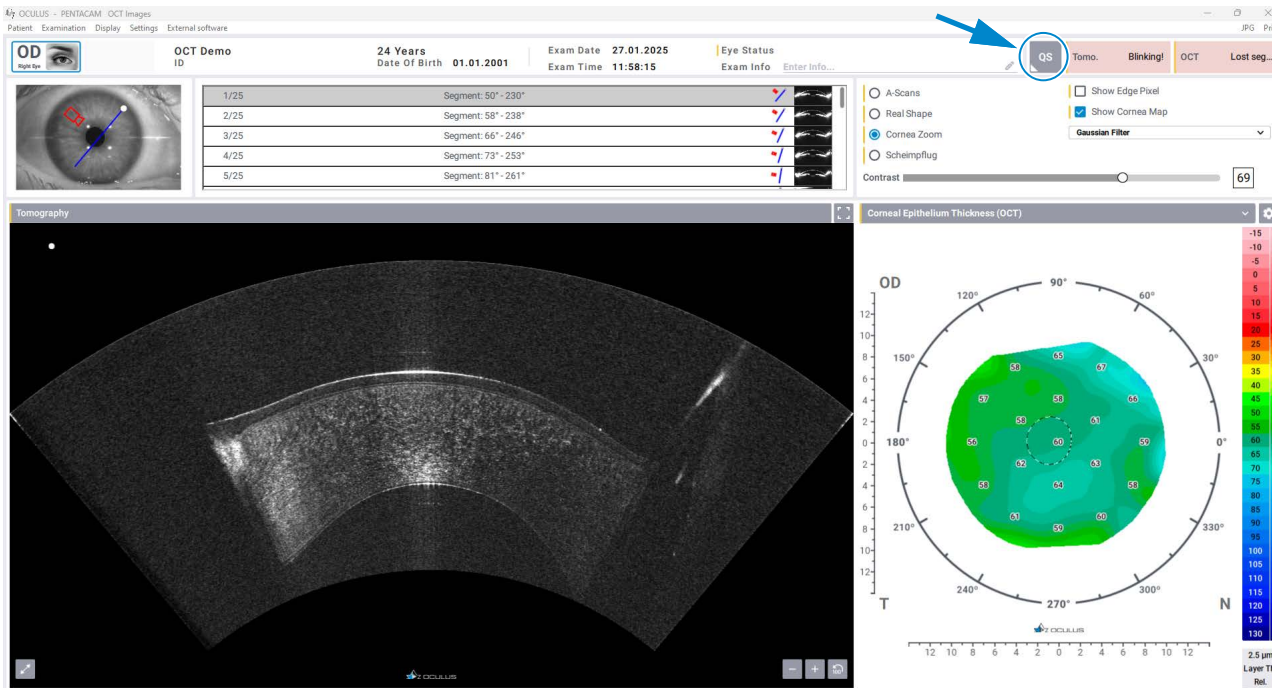

Fig. 14 "QS" field in OCT Images

In the example image you can see a failed measurement. The patient blinked during the recording. The measurement results are incomplete and cannot be used. The measurement must be repeated.

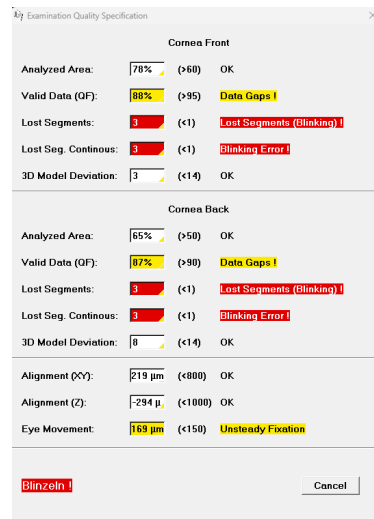

Fig. 15 QS opened in "General Overview"

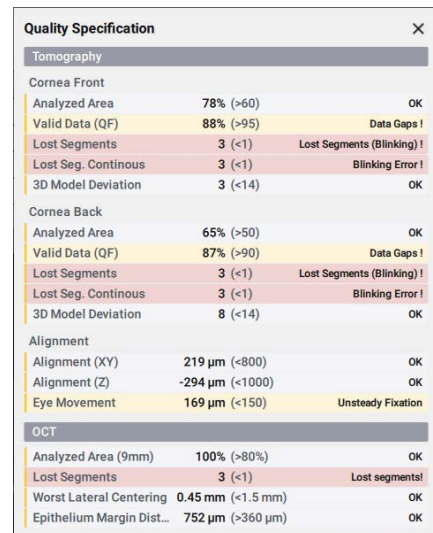

Fig. 16 QS opened in "OCT Images"

Field	If an error occurs here, ...
Analyzed area	... the measured area of the cornea is too small. → The patient must open their eye wider. If necessary, support the patient by holding the upper eyelid.

Field	If an error occurs here, ...
Valid data	<p>... no continuous data points could be determined in the Scheimpflug images, which can sometimes be the case with irregular or very cloudy corneas. In such a case, a maximum of yellow highlighted values can be expected even if the measurement is repeated.</p> <p>Or an ambient light source has disturbed the recording.</p> <p>→ Darken the room completely.</p>
Lost segments Lost seg. continuous	<p>... the patient has blinked or the nasal shadow is too large.</p> <p>→ Before the measurement process begins, the patient should blink again and then fixate the red LED or the black ring of the Pentacam® during the measurement process without blinking.</p> <p>→ If the error is caused by the nose covering the camera line, you must turn the patient's head slightly so that the nose is positioned away from the camera.</p>
Alignment (XY) Alignment (Z)	<p>... the device was moved during the measurement triggering.</p> <p>→ Repeat the measurement.</p>
Eye movement	<p>... the patient has not fixed the target correctly.</p> <p>→ Before the measurement process begins, the patient should blink again and then fixate the red LED or the black ring of the Pentacam® during the measurement process without blinking.</p>
Worst lateral centering	<p>... the lateral centering of the cornea is too bad.</p> <p>→ The patient must keep the eye open and fixate the target of the device once the scanning process has started.</p>
Epithelium Margin Dist...	<p>... the distance to the Epithelial margin is too small.</p> <p>→ Use the joystick to realign the device. Ensure that the cornea is well centered in the live image and bring the anterior corneal coverage area to the red line.</p>



All examinations are stored automatically, irrespective of the quality of the current measurement.

6.8 Finish Measurement

6. Click [Cancel] to close the window.
7. End the current, saved examination or prepare the measurement of a new patient
Menu [Patient] -> [New patient/End].

The Pentacam® program is closed. You return to the patient data management and can create or select a new patient there.

- Please refer to the patient data management manual.

7 Cleaning, Disinfection and Maintenance

To ensure a high degree of measurement accuracy of the device, OCULUS Optikgeräte GmbH recommends conducting maintenance every year or every 25000 scans.

- If an error occurs that you cannot alleviate, label the device as out-of-order and notify our service.

The device will inform you of the upcoming maintenance in various ways:

- In the daily display window

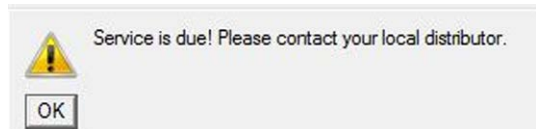

- In settings, refer to the User Guide:
Date of next service or number of examinations conducted

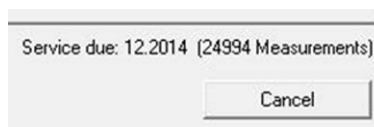

- In the scan menu → chap. 5 (page 26) as preliminary information (3 months before)

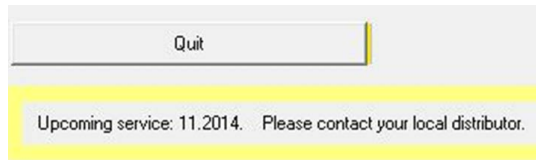

or when service is due.



- During an examination (this is saved), a symbol appears next to the QA field.



- Please contact OCULUS service or your local dealer to arrange a maintenance appointment.

Steps for cleaning the device are described in this chapter.

No sterilization is necessary.

- Observe the product descriptions or instructions for use of the agents and devices that you use for the care and cleaning of the appliance or accessories.
- Do not clean the device with aggressive, chlorinated, abrasive, or harsh cleaning agents.

7.1 Cleaning, Disinfection and Servicing Intervals

Interval	Task
Prior to each use	Place fresh paper onto the chin rest or disinfect the chin rest if no paper is used
Prior to each use	Disinfect the forehead rest
Monthly	Clean the device (housing, illuminated slit)
Monthly	Perform a test measurement
Every year or after 25 000 measurements	Maintenance by OCULUS service or by an authorized dealer

7.2 Consumables

Chinrest paper	400 sheets, Art.-No. 65313
LidStick	2 rolls of 100 each, Art.-No. 77502
Disinfection wipes	mikrozid® sensitive wipes premium Fa. Schülke & Mayr GmbH various packaging sizes: e.g. 2x 50 pieces im Soft-pack, Art.-No. 59882

7.3 Cleaning



Warning

Risk of electric shock if the device is not disconnected from the power supply at all poles for these tasks.

- ➔ Switch the device off → chap. 4.7 (page 25).
- ➔ Pull the power plug before cleaning. To do this, pull on the power plug, not on the cable itself.

Required materials:

- Anti-static cleaner for plastic surfaces
- Cleaner for painted surfaces: Mixture of equal parts alcohol and distilled water, possibly with a few drops of household detergent
- Soft, lint-free cloth
- Purified compressed air

7.3.1 Cleaning the Housing

- It is best to clean the housing surfaces with a soft cloth and an anti-static cleaning agent.
- Wipe off any residue from painted surfaces with the mixture for painted surfaces.

7.3.2 Cleaning the Chin and Forehead Rests

- Make sure that no liquids penetrate into one of the openings of the device.
- Clean the chin rest and the forehead support with a soapy solution (use alcohol if very dirty).
- Use a lint-free, damp cloth.

7.3.3 Cleaning the Illuminated Slit

The optical components illuminating the slit, and the lens in front of the camera are precision parts and sensitive to pressure. The surfaces of these components are susceptible to scratching.



Note

Damage to the optical components

- Do not use any cloths or other cleaning agents to clean the illuminated slit.

-
- Clean the illuminated slit carefully from the center using purified compressed air only.
 - Clean the lens in front of the camera very carefully using a dry, lint-free cloth.

7.4 Disinfection

- Use disinfection wipes suitable for medical devices, recommendation see → chap. 7.2 "Consumables" (page 46).



Note

Equipment damage caused by disinfectant solution

The disinfectant solution may damage the surface of the equipment if it is sprayed onto it directly.

- Spray the disinfectant solution onto a cloth; do not spray it directly on the device.

-
- Disinfect the forehead rest after each examination.
 - If you do not use paper on the chin rest, disinfect the chin rest after each examination.

7.5 Attaching Paper to the Chin Rest

Take the following steps to place the chin rest paper:

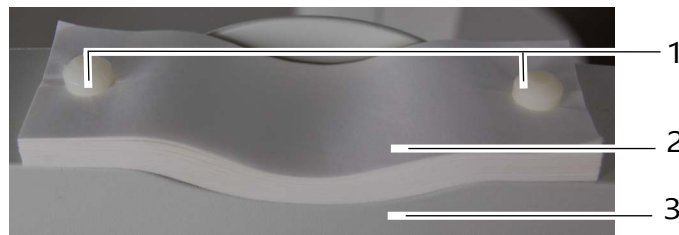

Fig. 17 Attaching the chin rest paper

- 1 Fastening pins 3 Chin rest
2 Chin rest paper

1. Pull the two fastening pins out of the chin rest.
 2. Place a new sheet of chin rest paper. The holes in the paper and the chin rest must align.
- Insert the two fastening pins through the paper and the chin rest.

7.6 Conducting Test Measurements

The device is tested and calibrated in-house at OCULUS prior to delivery. Moreover, OCULUS recommends conducting test measurements regularly.

- Start the test by measuring a human eye.
Conduct at least five consecutive measurements per eye.
Calculate the arithmetic average and record the values.
- **These measurements should be done once a month as described above with the same eye.**
- Compare the arithmetic average of the initial measurement with the current measurement.

The table below describes the tolerance range between the result of the initial measurement and the result of the current measurement:

	Tolerance range
Curvature	+/- 0.25dpt
Pachymetry	+/- 10µm

If the difference between the initial value and the actual measurement are outside of the tolerance range, please notify our Service or your authorized dealer.

8 Troubleshooting



Caution

Personal injury and/or property damage due to improper troubleshooting

→ If an error occurs that you cannot alleviate based on the following instruction, label the device as out-of-order and notify our Service or your authorized dealer.

Fault	Possible cause	Remedy
"No communication with the Pentacam!"	Power adapter without voltage	Check whether the indicator light on the power adapter is illuminated. If not, apply voltage to the power adapter.
	Power cord of the device is not properly plugged in	Check whether <ul style="list-style-type: none"> ■ The power cord is correctly inserted in the device. ■ The blue slit light is visible in the scan menu → chap. 5 (page 26). ■ The USB plug is properly connected.
	Software/hardware problems	Switch the device off; restart the computer. As soon as Patient Data Management is active, switch the device on. When starting up the Pentacam® program, the message "Load Bootloader" must appear. Contact Service or your authorized dealer.

9 Technical Data

Measuring Head

Camera	digital CMOS camera
Light source	blue LEDs (475 nm, UV-free)
Processor	DSP with 2746 million floating point operations/s
Speed (Scheimpflug)	100 recordings in 2 seconds (Cornea Fine Scan)
Number of evaluated measuring points	max. 276000
Dimensions W x D x H (without measuring base)	305 x 259 – 404 x 512 – 542 mm
Weight	27.8 kg

Measuring Range

Curvature	3 – 38 mm 9 – 99 dpt
Accuracy	± 0.1 dpt
Reproducibility	± 0.1 dpt
Working distance	45 mm
OCT system	
Axial resolution	1,9 µm
Lateral resolution	10 µm
Scan diameter	15 mm

Power Adapter

Type	GSM90B24-P1M (10029038)
Mains connection	100 – 240 V AC
Frequency	50/60 Hz
Power input, max.	144 VA
Output voltage	24 V DC
Fuses	Integrated overcurrent shutoff

Radiation Data

Laser	
Purpose	OCT measuring beam
Spectral range	780 nm – 1000 nm

Slit	
Purpose	Slit lamp illumination for Scheimpflug camera
Spectral range	470nm

IR-Illumination	
Purpose	Lighting for iris image
Wave length	840nm

Fixation light	
Purpose	Fixation light for the patient
Wave length	640nm

Power Supply

Voltage	24 VDC
Max. power consumption	75W

Life Expectancy

Expected life time	Up to 10 years
--------------------	----------------

IT Specifications

The IT equipment (computer, monitor etc.) must meet the requirements defined in IEC 62368-1.

Recommended computer specifications	Intel® Core™ i7, 2TB Drive, 32GB RAM, Windows® 11
Recommended screen size	24"
Recommended screen resolution	1920 x 1080 Pixel (Full HD)

Software Version

Pentacam® Software	from 1.32 version
--------------------	-------------------

Information about which software version is installed on your device can be found in the [Help] menu > "About..."

CE Marking

The device is a category IIa product.



Conformity assessment procedure according to (EU) 2017/745 MDR, Annex IX, Section I and III.

Classification

according to IEC 60825-1	
SLED	classified as a class 1 laser
Maximum output value of the laser radiation:	1.2mW
Pulse duration:	9.4µs
Number of pulses:	typically 50000
Wave length:	780 – 1000nm

according to IEC 60601-1	
Protection against electric shock	Protection class 2
Insulation of applied parts	Type B

10 Transport, Storage and Disposal

The device must be properly dismantled and packed before transporting and storing it.

10.1 Disassembly

1. Terminate the current session.
2. Switch off the device.
3. Disconnect the USB cable to the computer/laptop from the measuring box.
4. Disconnect the mains cable from the measuring box.
Pull the plug, not the cable!



Note

Risk of damage to the device due to further disassembly

The device is firmly mounted on the base. Separating the base from the device could damage the fiber optic cable in particular.

- ➔ Do not remove the device from the base.
- ➔ Do not disconnect any cables between the measuring head and the measuring box.

10.2 Storage Conditions

- Avoid proximity to radiators and moisture.

Ambient temperature	-10°C – +50°C
Relative humidity including condensation	10% – 95%
Air pressure	700hPa – 1060 hPa

10.3 Transport Conditions

Ambient temperature	-40°C – +50°C
Relative humidity including condensation	10% – 95%
Air pressure	500hPa – 1060hPa

10.4 Transport and Shipping

- Observe the dimensions and weight of the device → chap. 9 "Technical Data" (page 50).
- Observe the separate packaging instructions.



Note

Risk of device damage due to improper transport and storage

- Avoid shock, vibrations, and contamination.
- Avoid high temperatures and humidity.
- Use the original packaging with foam parts for safe transportation.
- Do not kink or crush the fiber optic cable.
- Lash the device securely on a pallet.
- Do not hold the device by the joystick to lift or carry it.

10.5 Disposal



In accordance with Directive 2012/19/EC of the European Parliament and the Council and, in accordance with German law governing the marketing, return and environmentally compatible disposal of used electrical and electronic devices, such appliances must be recycled and may not be disposed of as household waste.

- Dispose the device in a compliant manner.

11 Warranty Terms and Service

11.1 Warranty Terms

- Prior to or while operating the device, it is important that you observe the instructions for use and safety instructions.
- According to legal regulations, you are entitled to a warranty for the device.
- Any attempt by unauthorized persons at tampering with the device will void all warranty entitlements. This is because improper alterations and repairs can pose considerable risks to the user and the patient.
- Warranty entitlements also expire if unauthorized persons tamper with the supplied computer hardware and software.
- Please report any transport damage to the transport company immediately on or after delivery and have the damage confirmed on the consignment note so that proper claims can be settled.
- In general, our general terms and conditions of business and delivery apply in the version of the date of purchase.

11.2 Assumption of Liability for Functions and/or Damage

OCULUS will only accept responsibility for the safety, reliability and suitability for use of the device if you observe the following provisions:

- Use the device in conformance with this instructions for use.
- There are no parts on or in the device that must be maintained or repaired by the user. If assembly work, upgrades, adjustments, repairs, modifications or service work are performed by unauthorized personnel, or if the device is improperly maintained or handled, then this will void any liability on the part of OCULUS.
- If the work described above is performed by authorized persons, they are required to provide a certificate stating the type and scope of the repair, including any changes to the nominal data or the work area. The certificate must include the date and execution as well as company details with signature.
- Upon request, OCULUS will provide the authorized person with lists of spare parts and additional descriptive material for this purpose.
- Please be sure to use only original OCULUS parts for repairs.

12 Appendices

12.1 Electromagnetic Compatibility (EMC)

Electrical medical devices are subject to special precautionary requirements with respect to EMC, and must be installed and operated according to the EMC instructions provided in the accompanying documents.

OCULUS devices and systems are suitable for use in environment in professional health care facilities, such as doctors' offices or clinics; however, they must not be used in proximity to HF surgical units or inside of the HF shielded room of an ME system for magnetic resonance imaging.

No special measures must be observed for OCULUS devices and systems.



Note

Portable and mobile HF communication devices may interfere with medical electrical devices and potentially interfere with their performance.

The device is intended for use in an electromagnetic environment with uncontrolled radiated RF interference. The user of the device can help prevent electromagnetic interference by maintaining a minimum distance between portable and mobile RF communications equipment (transmitters) and the device as recommended below, according to the maximum output power of the communications equipment:

- Portable RF communications equipment (including peripherals such as antenna cables and external antennas) may not be used closer than 30cm (12 inches) to any part of the device.

Definition of the minimum operating quality or essential performance criteria:

- A slight disturbance of the analog camera of the device (slight image noise in the display) during the examination is permissible, because it does not interfere with diagnosis, treatment, and monitoring.
- A short flicker in the illumination of the device during the examination is permissible, because it does not interfere with diagnosis, treatment, and monitoring.
- A short interruption of the USB connection during the examination is permissible, because it does not interfere with diagnosis, treatment, and monitoring.



Caution

Use of accessories, transducers, and lines not specified by OCULUS may result in increased emissions or decreased immunity of the device.

- In connection with the device only use accessories, transducers, and lines that are specified by OCULUS.
- Do not use accessories, transducers, and line that are specified by OCULUS with other devices.

To achieve conformance with IEC 60601-1-2 requirements, use the following devices, accessories, transducers, and lines:

Description	
Cord with plug, EU standard	2.5m
Cord with plug, US standard (110 Volt)	2.5m
Power adapter GSM90B24-P1M	24V, 3.75A

12.2 Guidance and Manufacturer's Declaration: Electromagnetic Emissions and Immunity

Electromagnetic radiation		
The Pentacam® Cornea OCT offered by OCULUS is intended for operation in the electromagnetic environment defined below. The user of the Pentacam® Cornea OCT should ensure that it is in fact used in such an environment.		
Interference emission measurements	Compliance	Electromagnetic environment – guidance
RF emissions In accordance with CISPR 11	Group 1	The device uses high-frequency energy only for its internal function. Therefore, its RF emissions are very low and it is unlikely to cause any interference in nearby electronic equipment.
RF emissions in accordance with CISPR 11	Class B	
Harmonics emission in accordance with IEC 61000-3-2	Class A	
Emissions from voltage fluctuations/flicker in accordance with IEC 61000-3-3	Complies	

Electromagnetic immunity			
Immunity tests	IEC 60601 Test level	Compliance level	Electromagnetic environment – guidance
Electrostatic discharge electricity (ESD) in accordance with IEC 61000-4-2	± 8kV contact discharge ± 15kV Air discharge	± 8kV ± 15kV	Floors should be made of wood or concrete or covered with ceramic tiles. If the floor is covered with synthetic material, the relative humidity must be at least 30%.
Rapid transient electrical disturbances / bursts in accordance with IEC 61000-4-4	± 2kV for power cables ± 1kV for Input and Output Lines	± 2kV ----- ± 1kV	The quality of the supply voltage should be that of a typical commercial or hospital environment.
Surges in accordance with IEC 61000-4-5	± 1kV push-pull voltage ± 2kV Common-mode voltage	± 1kV ± 2kV	The quality of the supply voltage should be that of a typical commercial or hospital environment.
Voltage dips, short interruptions, and voltage variations in power supply input lines in accordance with IEC 61000-4-11	0% U_r ; 1/2 period at 0, 45, 90, 135, 180, 225, 270 and 315 degrees 0% U_r ; 1 period and 70% U_r ; 25/30 periods Single phase: at 0 degrees 0% U_r ; 250/300 periods	0% U_r ; 1/2 period at 0, 45, 90, 135, 180, 225, 270 and 315 degrees 0% U_r ; 1 period and 70% U_r ; 25/30 periods Single phase: at 0 degrees 0% U_r ; 250/300 periods	The quality of the supply voltage should be that of a typical commercial or hospital environment. If the user of the Pentacam® Cornea OCT requires continued operation in case of power supply interruptions, it is recommended to power the Pentacam® Cornea OCT from an uninterruptible power supply or a battery.
Magnetic field in the supply frequency (50/60Hz) in accordance with IEC 61000-4-8	30A/m 50Hz or 60Hz	30A/m 50Hz or 60Hz	Magnetic field for the line frequency should be typical values, equivalent to those typically found in a commercial and hospital environment.
Comment: U_r is the AC line voltage before applying the test level			

Electromagnetic immunity			
Immunity tests	IEC 60601 test level	Compliance level	Electromagnetic environment – guidance
<p>Conducted RF interference variable in accordance with IEC 61000-4-6</p> <p>Radiated RF interference variable in accordance with IEC 61000-4-3</p>	<p>3V_{eff} 150KHz to 80Mhz</p> <p>3V/m 80MHz to 2.5GHz</p>	<p>V_{eff} = 3V</p> <p>E = 3V/m</p>	<p>Portable and mobile radio equipment should not be used at a distance to the Pentacam® Cornea OCT any less than the recommended separation distance, which is calculated based on the equation applicable to the transmitting frequency.</p> <p>Recommended separation distance:</p> $d = \left[\frac{3, 5}{(V_1)} \right] \sqrt{P}$ $d = \left[\frac{3, 5}{(E_1)} \right] \sqrt{P} \quad \text{For 80MHz to 800MHz}$ $d = \left[\frac{7}{(E_1)} \right] \sqrt{P} \quad \text{For 800MHz to 2.5GHz}$ <p>Whereas P is the rated output of the transmitter in watts (W) pursuant to the specifications from the transmitter manufacturer and d the recommended separation distance in meters (m). The field strength from stationary radio transmitters should be lower than the compliance level (b) at all frequencies as defined by a site test (a). Interference may occur in the environment of devices that marked with the following symbol:</p> 
<p>Comment 1:</p> <p>Comment 2:</p>	<p>The higher frequency range applies at 80Hz and 800MHz.</p> <p>These guidelines may not apply in all scenarios. Absorption and reflection of buildings, objects, and people affect the electromagnetic propagation.</p>		
<p>a. The field strength of stationary transmitters, such as base stations radio phones and mobile terrestrial radios, amateur radio stations, AM and FM radio and television transmitters cannot theoretically be accurately predicted. To calculate the electromagnetic environment with respect to stationary transmitters, a site study should be considered. If the measured field strength at the site where the Pentacam® Cornea OCT is used exceeds the compliance level above, the Pentacam® Cornea OCT should be observed to verify that it functions as intended. If abnormal performance patterns are observed, you may need to take additional measures, such as changing the orientation of or relocating the Pentacam® Cornea OCT.</p> <p>b. At a frequency range over 150kHz to 80Mhz, the field strength should be less than 3V/m.</p>			

Recommended separation distance: between portable and mobile RF telecommunication devices and the Pentacam® Cornea OCT

The Pentacam® Cornea OCT is intended for operating in an electromagnetic environment where RF interference is controlled. The user of the Pentacam® Cornea OCT can help prevent electromagnetic interference by maintaining a minimum distance between portable and mobile RF communications equipment (transmitters) and the device – depending on the output power of the communications equipment as defined below.

Rated output of the transmitter W	Separation distance depending on the transmitter frequency in m		
	150kHz to 80MHz $d = 1.2 \sqrt{P}$	80 MHz to 800MHz $d = 1.2 \sqrt{P}$	800MHz to 2.5GHz $d = 2.3 \sqrt{P}$
0.01	0.12	0.12	0.23
0.1	0.38	0.38	0.73
1	1.2	1.2	2.3
10	3.80	3.80	7.3
100	12	12	23

For transmitters with a maximum rated output that is not listed in the chart above, the recommended separation distance: d in meters (m) can be calculated using the equation corresponding to the relevant column, whereas P equals the maximum rated output of the transmitter in watts (W) pursuant to the specification from the transmitter manufacturer.

Comment 1: The higher frequency range applies at 80MHz and 800MHz.

Comment 2: These guidelines may not apply in all scenarios. Absorption and reflection of buildings, objects, and people affect the electromagnetic propagation

12.3 Connection Diagram

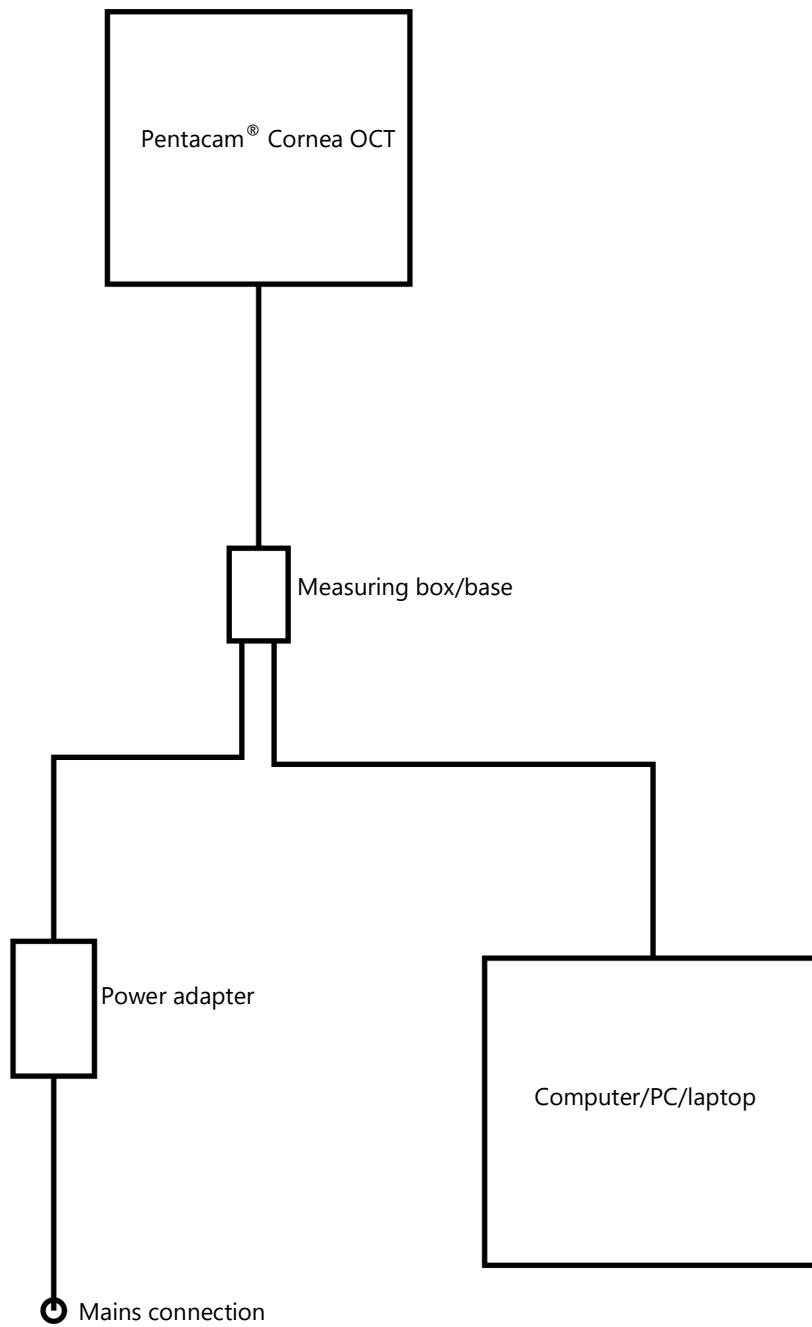

12.4 Data Sheet for GSM90B24-P1M Power Adapter [10029038]



90WAC-DC Single Output Medical Adaptor

GSM90B series



■ Features

- Universal AC input / Full range
- 2 pole AC inlet IEC320-C8
- Built-in active PFC function, PF>0.91
- High efficiency up to 91%
- Low leakage current <100µA
- Protections: Short circuit / Overload / Over voltage/ Over temperature
- Fully enclosed plastic case
- Medical safety approved (2×MOPP between primary to secondary)
- Class II power (without earth pin)
- LED indicator for power on
- No load power consumption<0.15W
- ErP step2 compliant (level V)
- Meet EISA 2007 (Energy Independence and Security Act)
- 100% full load burn-in test
- Optional lock type DC plug
- 3 years warranty

■ Applications

- Mobile clinical workstation
- Oral irrigator
- Portable hemodialysis machine
- Breath Machine
- Medical computer monitor

■ Description

GSM90B is a highly reliable, 90W single-output green medical adaptor series. This product is equipped with a 2-pin (no FG) standard IEC320-C8 power plug, adopting the input range from 80VAC to 264VAC. The entire series supplies different output voltages between 12VDC and 48VDC that can satisfy the demands for various kinds of medical electrical devices. The circuitry design meets the international medical standards (2*MOPP), having an ultra low leakage current (<100µA), fitting the medical devices in direct electrical contact with the patients.

With the efficiency up to 91% and the extremely low no-load power consumption below 0.15W, the design of GSM90B observes the latest energy regulation (Level V); the supreme feature allows the adaptor to save the energy when it is either under the operating mode or the standby mode. The entire series utilizes the 94V-0 flame retardant plastic case, providing the double insulation that effectively prevents electrical shock. GSM90B is approved with the international medical safety certificates.

■ Model Encoding

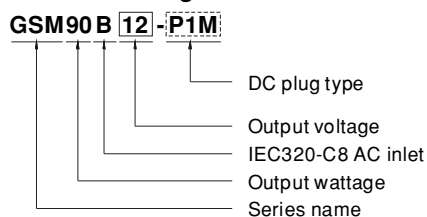

File Name:GSM90B-SPEC 2014-03-12



90W AC-DC Single Output Medical Adaptor

GSM90B series
SPECIFICATION

ORDER NO.	GSM90B12-P1M	GSM90B15-P1M	GSM90B19-P1M	GSM90B24-P1M	GSM90B48-P1M	
OUTPUT	SAFETY MODEL NO.	GSM90B12	GSM90B15	GSM90B19	GSM90B24	GSM90B48
	DC VOLTAGE <small>Note.2</small>	12V	15V	19V	24V	48V
	RATED CURRENT	6.67A	6A	4.74A	3.75A	1.87A
	CURRENT RANGE	0 ~ 6.67A	0 ~ 6A	0 ~ 4.74A	0 ~ 3.75A	0 ~ 1.87A
	RATED POWER (max.)	80W	90W	90W	90W	90W
	RIPPLE & NOISE (max.) <small>Note.3</small>	120mVp-p	150mVp-p	180mVp-p	200mVp-p	240mVp-p
	VOLTAGE TOLERANCE <small>Note.4</small>	±5.0%	±5.0%	±4.0%	±3.0%	±2.5%
	LINE REGULATION <small>Note.5</small>	±1.0%	±1.0%	±1.0%	±1.0%	±1.0%
	LOAD REGULATION	±5.0%	±5.0%	±4.0%	±3.0%	±2.5%
	SETUP, RISE TIME <small>Note.6</small>	100ms, 50ms / 230VAC 150ms, 50ms / 115VAC at full load				
HOLD UP TIME (Typ.)	20ms / 230VAC 20ms / 115VAC at full load					
INPUT	VOLTAGE RANGE	80 ~ 264VAC 113 ~ 370VDC				
	FREQUENCY RANGE	47 ~ 63Hz				
	POWER FACTOR (Typ.)	PF>0.91 / 230VAC PF>0.95 / 115VAC at full load				
	EFFICIENCY (Typ.)	88%	89%	89%	90%	91%
	AC CURRENT (Typ.)	1.3A / 115VAC 0.6A / 230VAC				
	INRUSH CURRENT (Typ.)	30A / 115VAC 65A / 230VAC				
	LEAKAGE CURRENT(max.)	Touch current < 100 μ A/264VAC				
PROTECTION	OVERLOAD	110 ~ 150% rated output power Protection type : Hiccup mode, recovers automatically after fault condition is removed				
	OVER VOLTAGE	105 ~ 135% rated output voltage Protection type : Shut down o/p voltage, re-power on to recover				
	OVER TEMPERATURE	Shut down o/p voltage, re-power on to recover				
ENVIRONMENT	WORKING TEMP.	-30 ~ +60°C (Refer to "Derating Curve")				
	WORKING HUMIDITY	20% ~ 90% RH non-condensing				
	STORAGE TEMP., HUMIDITY	-40 ~ +85°C, 10 ~ 95% RH				
	TEMP. COEFFICIENT	±0.03% / °C (0 ~ 40°C)				
SAFETY & EMC (Note. 7)	VIBRATION	10 ~ 500Hz, 2G 10min./1cycle, period for 60min. each along X, Y, Z axes				
	SAFETY STANDARDS	ANSI/AAMI ES60601-1 / ES60601-1-11, TUV EN60601-1 / EN60601-1-11 approved				
	WITHSTAND VOLTAGE	I/P-O/P: 4KVAC				
	ISOLATION RESISTANCE	I/P-O/P: 100M Ohms / 500VDC / 25°C / 70% RH				
	EMC EMISSION	Compliance to EN55011(CISPR11) class B, EN61000-3-2,3, FCC PART 15 class B				
OTHERS	EMC IMMUNITY	Compliance to EN61000-4-2,3,4,5,6,8,11, EN55024, EN60601-1-2, EN61204-3 medical level, criteria A				
	MTBF	405.6K hrs min. MIL-HDBK-217F(25°C)				
	DIMENSION	145*60*32mm (L*W*H)				
CONNECTOR	PACKING	0.45Kg; 30pcs/14.5Kg/1CUFT				
	PLUG	See page 2 ; Other type available by customer requested				
	CABLE	See page 2 ; Other type available by customer requested				
NOTE	1. All parameters are specified at 230VAC input, rated load, 25°C 70% RH ambient. 2. DC voltage: The output voltage set at point measure by plug terminal & 50% load. 3. Ripple & noise are measured at 20MHz by using a 12" twisted pair terminated with a 0.1uf & 47uf capacitor. 4. Tolerance: includes set up tolerance, line regulation, load regulation. 5. Line regulation is measured from low line to high line at rated load. 6. Length of set up time is measured at first cold start. Turning ON/OFF the power supply may lead to increase of the set up time. 7. The power supply is considered as an independent unit, but the final equipment still need to re-confirm that the whole system complies with the EMC directives. For guidance on how to perform these EMC tests, please refer to "EMI testing of component power supplies." (as available on http://www.meanwell.com)					

File Name: GSM90B-SPEC 2014-03-12



90W AC-DC Single Output Medical Adaptor

GSM90B series

Derating Curve

Ambient Temperature (°C)	Load (%)
-30	100
0	100
10	100
20	100
30	100
40	100
50	75
60	50
70	0

Static Characteristics

Input Voltage (VAC) 60Hz	Load (%)
80	80
90	90
100	100
110	100
120	100
130	100
140	100
150	100
160	100
170	100
180	100
190	100
200	100
210	100
220	100
230	100
240	100
250	100
264	100

Mechanical Specification

Case No. GS90A Unit:mm

UL1185 14AWG 1000±50mm for 12 ~ 15V
UL1185 16AWG 1200±50mm for 19 ~ 48V

70±10mm

11±0.5mm

ID 2.5 x OD 5.5

Outside ⓪ ⊕ ⊖ Inside

Plug Assignment

Standard plug: P1M

P1M	
P/N	OUTPUT
CENTER	+

Optional lock type plug: P2S
SWITCHCRAFT S761K plug equivalent

Installation Manual

Please refer to : <http://www.meanwell.com/webnet/search/InstallationSearch.html>

File Name:GSM90B-SPEC 2014-03-12

12.5 Instructions for Integration into an IT Network

The device in combination with the connected computer and the device software that runs on it form a programmable medical electrical system (PEMS system) in accordance with IEC 60601-1.

It is essential to observe the section → chap. 2.3 “Instructions for Cybersecurity” (page 13) in the chapter “Safety Instructions” (→ page 9) in the device’s operating instructions.

Please observe the instructions for integrating the PEMS in an IT network:

The purpose of integrating the PEMS into an IT network may be:

- Licensing by the local license server
- Storing and pulling up examination data on a local network drive
- Printing
- Data export
- DICOM workflow

Required characteristics of the IT network that the PEMS is to be integrated:

- Give preference to a wired LAN connection
- Ipv4 network
- Fast Ethernet (min. 1Gbit/s)

Required configuration of the IT network that the PEMS is to be integrated:

- License: Required open ports: 3968 TCP; 51371 - 51372 UDP
- Storing, printing, data export: File and printer sharing for Microsoft networks (SMB 3.0 or higher – required open port: 445]
- DICOM storage service class = PACS
- DICOM Worklist Management Service class (Modality Worklist Server)

Technical specifications for the network connection with the PEMS, including the specifications for data security:

- Read the section on cybersecurity (→ page 13) under “Safety Instructions” (→ page 9) in the device’s operating instructions.
- Refer to the operating instructions for “Floating License Key – License management for software options”
- Refer to the device specific DICOM interface description

The intended flow of information between PEMS, the IT network and other devices in the IT network and the intended routing by the IT network

- License handling from the local license service to PEMS and vice versa
- Storage and data export to local network storage and loading from local network storage
- Printing on local printer

List of potential risks resulting from the IT network being unable to provide the functions required to meet the purpose of integrating the PEMS into the IT network:

- Loss of data
- Unsuitable data exchange
- Data corruption
- Unsuitable time-based data allocation
- Unexpected data reception
- Unauthorized access to data



Connecting the PEMS to an IT network that includes other devices may result in risks for patients, operators, and third parties that have not yet been identified.

The responsible organization should identify, analyze, evaluate, and control these risks.

Any changes to the IT network later on may involve new risks and require additional analyses.

Changes in the IT network may include:

- Changes in IT network configuration
- Connecting additional items to the IT network
- Disconnecting elements from the IT network
- Updating the devices connected to the IT network

WWW.OCULUS.DE

OCULUS Optikgeräte GmbH

Münchholzhäuser Str. 29 • 35582 Wetzlar • GERMANY

Phone +49 641 2005-0 • Fax +49 641 2005-255

E-mail: sales@oculus.de • www.oculus.de

OCULUS Inc.

17721 59th Avenue NE • Arlington • WA 98223

Phone +1 425 670 9977 • Fax +1 425 670 0742

E-mail: sales@oculususa.com • www.oculususa.com

10031884 / US / Rev00
Lot:

