

OCULUS Myopia Master®



INSTRUCTION MANUAL

Notes on this instruction manual

The Myopia Master® has been manufactured and tested according to strict quality criteria. To ensure safe operation, it is essential that you use the device correctly. For this reason you should familiarise yourself thoroughly with the contents of this instruction manual before operating the device. In particular, pay attention to the safety instructions.

- This instruction manual describes the measuring procedure, how to manage the patient data, and the settings in the Myopia Master® program.

Due to ongoing development, the diagrams shown may depict minor changes to the actual device delivered.

If you have any queries or would like additional information about your device, do not hesitate to call or send us an email or a fax. Our service team will gladly assist.

OCULUS Optikgeräte GmbH

Revision 07

Release: 29.10.2021



OCULUS is certified according to DIN EN ISO 13485, setting high standards of quality for the development, manufacture, quality assurance and service of the entire range of products.

Table of Contents

Table of Contents	ii
1 Scope of Delivery.....	1
2 Graphic Symbols.....	2
3 Structure of the Documentation	4
4 Safety Instructions.....	5
4.1 About this Manual	5
4.1.1 Pictogram Used in this Manual	5
4.2 Safety Instructions for Use	6
4.3 Cybersecurity Instructions	10
5 Intended Use.....	13
6 Transport to Installation Location.....	14
7 Device Description	15
7.1 Overview of Device Components	15
7.2 Mode of Operation of the Myopia Master®.....	17
8 Set up and Connection.....	19
8.1 Initial Start-up	19
8.2 Set-up Jobs for Initial Start-Up	19
8.3 Adjustments after an in-house transport.....	20
8.3.1 Device set-up	20
8.3.2 Unlock transport safety device	20
8.4 Electrical Connection	22
9 Operation.....	24
9.1 Switching On	24
9.2 Switching Off.....	24
9.3 Daily Operation	24
10 Functions of the Control Pad.....	25
10.1 Touch Screen.....	26
10.1.1 Function Keys on the Touch Screen	26
11 Preparing Patients Data	27
11.1 Entering new Patients (touch screen)	27
11.2 Entering new Patients (touch screen deactivated).....	29
11.2.1 Selecting existing Patients.....	30
11.2.2 Rename a Patient	30
11.2.3 Delete a Patient or an Examination	31
11.2.4 Load an Examination	32
12 Measuring Procedure	33
12.1 Selecting a Measurement Mode	33
12.2 Preparing a Measurement.....	34
12.3 Myopia measurement and results	37
12.3.1 Myopia Overview Display	37

12.3.2	Myopia Results.....	38
12.3.3	Refraction Results.....	41
12.3.4	Axial length results.....	42
12.3.5	Pachymetry results (optional).....	43
12.3.6	Ending the measurements.....	43
12.4	Printing and Saving Examinations.....	44
12.4.1	Printing.....	44
12.4.2	Saving an examination.....	45
12.5	Complete measurement.....	45
13	Chronology of Different Measuring Processes.....	46
13.1	Enter Patient + Measure.....	46
13.2	Saving an Examination Retroactively.....	47
13.3	Measuring Without Saving the Patient Data.....	48
14	Reference Measurement.....	49
15	Settings.....	51
15.1	Settings 1.....	51
15.2	Settings 2.....	53
15.3	Settings 3.....	55
15.4	Settings 4.....	56
15.5	Settings 5.....	58
16	Cleaning, Disinfection and Maintenance.....	59
16.1	Cleaning.....	59
16.2	Disinfection.....	61
16.3	Maintenance.....	62
16.4	Attaching Paper to the Chin Rest.....	63
16.5	Inserting a New Roll of Printer Paper.....	64
17	Troubleshooting.....	66
18	Dismantling, Transport and Storage.....	67
18.1	Disassembly.....	67
18.2	Transport and Storage Information.....	67
18.3	Transport and Storage.....	67
19	Disposal.....	68
20	Terms of Warranty and Servicing.....	68
20.1	Terms of Warranty.....	68
20.2	Assumption of Liability for Functions and Damage.....	69
20.3	Manufacturer and Service Address.....	69
21	Technical Data.....	70
22	Annex.....	73
22.1	Electromagnetic Compatibility.....	73
22.2	Guidance and Manufacturer's Declaration - Electromagnetic Emissions and Immunity for the Myopia Master® 75	
22.3	Description of the Connection.....	79

22.4	Data Sheet GSM60B15-P1J (05150725).....	80
22.5	Notes for integration into an IT-Network.....	83

1 Scope of Delivery



















Products and accessories	Order number
Version	
<ul style="list-style-type: none"> ■ Myopia Master® Advanced with chin and head rest (not available) incl. auto-refractometer, keratometry, axial length, pachymetry ■ Myopia Master® Advanced without chin and head rest (not available) incl. auto-refractometer, keratometry, axial length, pachymetry ■ Myopia Master® Basic with chin and head rest incl. auto-refractometer, keratometry, axial length ■ Myopia Master® Basic without chin and head rest incl. auto-refractometer, keratometry, axial length ■ Myopia Master Optiswiss with chin and head rest (only available via Optiswiss AG) incl. auto-refractometer, keratometry, axial length 	<p style="text-align: right;">68100</p> <p style="text-align: right;">68110</p> <p style="text-align: right;">68120</p> <p style="text-align: right;">68130</p> <p style="text-align: right;">10010728</p>
Eye shield black	076500001028
Dust protection cover	026010005001
Paper for chin support	65313
Printing paper roll (3 rolls)	65311
USB mini cable	05200600
USB FS MED-Isolator	015692000010
Power adapter	05150725
Cable, EU	5200905
Cable, GB (optional)	5200915
Cable, USA (optional)	5200910
Cable, AU (optional)	5200920
Cable, Argentina (optional)	5200925
Testeye	68105
Software-Installation	SI/50000/.../en
Instruction Manual	G/68100/EN Rev05

- ➔ If you find transport damage upon delivery, immediately file a claim with the transport company.
- ➔ Have the damages noted on the bill of lading, so that your claim for damages can be handled properly.
- ➔ Keep the packaging. Keep the packaging in order to ship or transport the device properly if service or repairs are needed. You will thus avoid incurring unnecessary damage and costs.







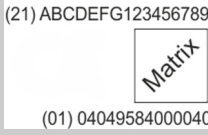

Note

We reserve the right to change the scope of delivery in line with ongoing technical development.

2 Graphic Symbols

Symbols equipment			Symbols packaging		
	Manufacturer		Protection class		Keep dry
	Date of manufacturing	IP XX	Type of protection		This way up
	Conformité européenne		Article number		Fragile
	Follow instruction for use		Serial number	Transport 	Limit of temperature for transport
	Disposal in household trash is prohibited		Caution	Lagerung 	Limit of temperature for storage
	Applied part Type B		Do not re-use		Limit of humidity
			Medical device		Limit of air pressure
		Example: UDI number, consisting UDI-DI (Device-Identification) UDI-PI (Product Identifier) machine-readable matrix code			

Additional Symbols and abbreviations on power adapter

	Indoor use only		Testing center		Aquivalent to RoHS
	Conform to US and Canadian standards		Nemkos symbol		Chinese Standard Sign
	Meets German safety requirements		Polarity of DC connector		

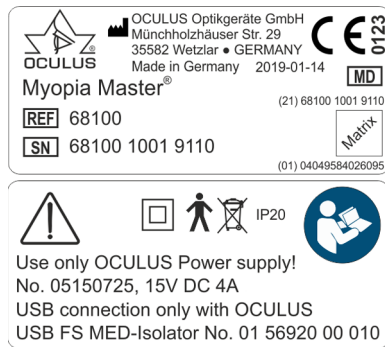

Fig. 2-1: Name plate (example)

There are no temporarily fixed markings on the device.

3 Structure of the Documentation

A folder containing documentation is supplied with your Myopia Master[®]:

- **Instruction Manual:** The design of the unit is described in detail in this document. The instruction manual also gives you general information about working with the Patient Data Management system and all safety-related instructions for use of the Myopia Master[®].



Attention

All safety-related instructions for use of the Myopia Master[®] are given in the Instruction Manual for the unit. It is imperative that you read and understand the whole Instruction Manual before you use the Myopia Master[®].

-
- **User Guide:** All features of the examination and analysis software are described in the User Guide, along with detailed information about the Patient Data Management system.
 - **Software Installation:** The introduction to the Software Installation describes how to install the Myopia Master[®] software and the associated drivers.
 - **Manual Floating License Key:** Information on the use of the Myopia Master[®] within networks.

4 Safety Instructions

4.1 About this Manual

- Carefully read through the Instruction Manual.
- Keep the Instruction Manual in good condition near the device.
- Observe the legal regulations with regard to accident prevention.

If standards are named without an issue date, the current version always applies.

4.1.1 Pictogram Used in this Manual



Attention

Identifies a potentially dangerous situation which may cause minor injury or damage to property.



Note

Denotes situations which could result in incorrect findings, denotes user instructions and useful or other important information.



Identifies important information about the product and its use which require special attention.

- > This symbol denotes menu paths and screenshots. Example for starting a new examination:

Myopia Master® > Examination > Scan

which means:

- Select the "Examination" menu from the menu bar.
- Select the menu item "Scan".

4.2 Safety Instructions for Use



Attention

Personal injury or property damage due to improper operation

- ➔ Observe the following safety instructions.

Personal injury or property damage due to equipment modifications that could jeopardize safety

- ➔ No modifications may be made to this device without the permission of the manufacturer. Only the OCULUS service are allowed to make changes or modifications to the device.
-

Any serious-incident that has occurred in relation to the device should be reported to the manufacturer (vigilance@oculus.de) and the competent authority of the region in which the user and/or patient is established.

Instructions for Operating Personnel

- ➔ Make certain that the Myopia Master® is used exclusively in clinics and by eye specialists and opticians (trained staff etc.). It must be used in the area designated for carrying out examinations.
For this reason the device may only be operated by personnel instructed to do so, who, with appropriate training, knowledge and practical experience, are able to ensure proper handling of the device.

Transport and Storage Instructions

Refer to the notes in *sec. 18, page 67*.

Instructions for Setup and Connection

- ➔ Only OCULUS or an authorized dealer is allowed to set up and to connect the Myopia Master®.
- ➔ Do not use or store the Myopia Master® in rooms that are humid, see *sec. 18, page 67*.
- ➔ Keep the Myopia Master® away from water that may drip, splash or spray on it, and make sure that no liquids can get into the Myopia Master®. Do not place any containers holding liquids in the vicinity of the Myopia Master®.
- ➔ Germany: Only operate the Myopia Master® in rooms used for medical purposes after they have been set up according to the VDE Regulation 0100-710.
- ➔ Do not operate the devices included in the delivery in areas where explosions may occur, or in proximity to flammable anesthetics or volatile substances such as alcohol, benzene or similar products.

- ➔ Set up the Myopia Master® so that the power plug is easy to access. That way, you can easily disconnect it from the power supply for any repairs or maintenance work.
- ➔ Do not force any plug connections.
If you are unable to make a plug connection, check whether the plug fits the socket.
If you detect damage to the connection, you should let authorized dealer repair the damage.
- ➔ Only use a device which is mounted at the lifting table properly.

Patient environment information

Patient environment is the area where patients can come into contact with any part of a medical electrical equipment (ME equipment) or with another person being in contact with the ME equipment.



Attention

In the patient environment, use devices that conform to IEC 60601-1. If a multiple power socket is to be used, or if a device is to be used that does not meet the IEC 60601-1 standard, use an isolating transformer.

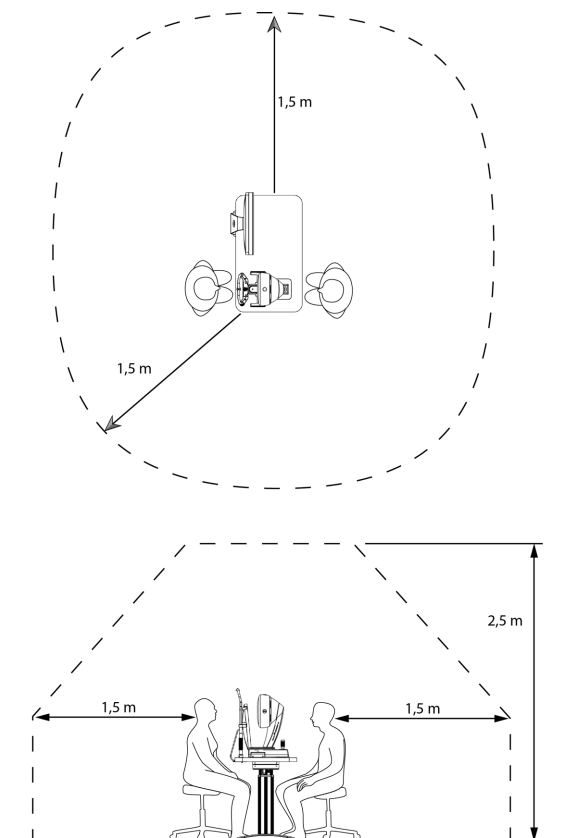

Fig. 4-1: Patient environment

Information about the operation of an ME system

The Myopia Master® and a connected computer form a medical electrical system (ME system) according to IEC 60601-1. If you connect additional devices, such as, for example a printer, those devices become part of the ME system.

- Make sure that all devices of the ME system meet the requirements of IEC 60601-1 or IEC 60950-1/IEC 62368-1.

Instructions for Operation

- Before first use: Let OCULUS or an authorized dealer train you in the operation of the Myopia Master®.
- Never operate a damaged Myopia Master®.
- Only operate the Myopia Master® with the original accessories supplied by us and only when the unit is in technically perfect condition.
- Do not cover the ventilation openings.
- Do not touch the patient and the device at the same time.
- Make sure that the device cannot tip over by leaning against it or sitting on it.
- Do not put the Myopia Master®, including rechargeable battery or cable, down onto devices that produce heat, heaters (for example radiators), microwaves or similar.
- Only operate the device if you have understood the operating instructions.



Caution

The light emitted from this instrument is potentially hazardous. The longer the duration of exposure and the greater the number of pulses, the greater the risk of ocular damage. Exposure to light from this instrument when operated at maximum output will exceed the safety guideline after 48 treatments.

Instructions for Laser Use



Attention

Risk of personal injury or material damage due to invisible laser radiation
 The Myopia Master® contains a Class 1 laser according to IEC 60825-1: 2014. It is an encapsulated laser system. When the Myopia Master® cover is opened, you may be exposed to invisible, Class 3R (5 mW) laser radiation.

- Never open the unit.

- For authorized service personnel only: When doing maintenance jobs, avoid looking directly into the laser beam.

Instructions for Maintenance

In order to retain the high measurement accuracy of the Myopia Master® OCULUS Optikgeräte GmbH recommends to perform a maintenance service every two years or after 25000 scans. Additionally to that it is useful to accomplish a test measurement of the axial length measuring mode everyday before you start working with the Myopia Master®.

If an error occurs which you cannot correct, label the Myopia Master® as being "out-of-order" and contact our service department, see [sec. 20.3, page 69](#).

Instructions for Disassembly and Disposal

- When disconnecting electrical connections, pull on the respective plug and not on the cable itself.
- Dispose of the device according to legal regulations.

Instructions on Electrical Safety



Attention

Risk of personal injury or damage to property due to an incorrect level of safety

Connecting the Myopia Master® with its non-medical electrical equipment (e.g. data processing equipment) to a medical electrical system must not result in a patient safety level below that prescribed by IEC 60601-1. If making this connection leads to the leakage current threshold being exceeded, protective measures including a circuit breaker must be in place.

- Ensure that connections with non-medical devices are made correctly.
- Only use the power adapter listed in the packing list.
- Use only a computer that meets the specifications given in this instruction manual, [page 72](#).

Use of a multiple socket extension cord

Risk of personal injury or material damage caused by unsafe multiple socket extension cord

If you use a multiple socket extension cord to connect the Myopia Master® to the power supply, you must heed the following information:

- Use an extension cord that complies with the requirements of IEC 60601-1, section 16.
- Do not place the multiple socket extension cord on the floor.
- Do not use more than one multiple socket extension cord.
- Plug only the Myopia Master® and the computer that is being used with the unit (if applicable) into the multiple socket extension cord.

If you are using a multiple socket extension chord it has to be supplied with a isolation transformer.

If you are using a new computer for the Myopia Master®, you must have the electrical safety checked. Call OCULUS Service for this purpose.



Attention

Electromagnetic Compatibility (EMC) / Cables

Risk of personal injury or damage to property due to electromagnetic interference

Portable and mobile RF communications equipment can affect medical electrical equipment [sec. 22, page 73](#).

- Make sure that portable and mobile RF communications equipment do not cause interference.
- Recommendation: Maintain a minimum distance of 4 m. If the distance is shorter, you must ensure that the Myopia Master® functions correctly.

4.3 Cybersecurity Instructions



The device itself was not designed to connect via a coupled computer to the internet or other network, or to portable media, as the device does not require a network or internet connection to function.

User who elect to connect the device coupled computer to the internet or other network for other purposes are responsible for ensuring that it is done so in a controlled manner.

Data responsibility:

The device itself is not designed to connect with the internet, but only with a computer. It does not require the internet to function.

Do not connect with the internet while using the device. It is considered misuse.

If you elect to connect the computer to the internet for other purposes you are responsible for ensuring data security.

Device Security

It is the responsibility of the authorized user to ensure that the Myopia Master® device is not left unlocked, or otherwise unsecured when not in use, to ensure that non-authorized medical, professional, or otherwise unapproved personnel are not exposed to, or gain access to, ePHI.

User Responsibility

User names or passwords must not be shared with colleagues or others, even if they are permitted by law and provider policy to view the same type of information (e.g. two operators reviewing the same patient samples).

Operators have access to patients' ePHI and must not take snap-shots, screenshots or pictures (e.g. using another device) of any information viewed through the device.

Operators should not enter identifying data into the device. All the data on the device should be de-identified and relate to the sample id and not to the patient.

Reporting Device Security or Privacy Breaches

Operators must contact their local IT department and disclose any suspected or confirmed compromised user accounts, and any other privacy or security breaches.

Recovering from Compromised Accounts or Devices

When accounts are considered compromised, devices are lost, or unauthorized access is discovered or suspected, the Healthcare Organization's IT network administrators suspend and modify the user login criteria and issue new login credentials for the user to access their account securely.

Unavailable Service

Users should report unavailable service or prohibited access to information to their local Healthcare Organization's IT department.

Precautions

→ To ensure cyber security in order to the usage of the device, the following security measures should be considered. Contact your computer administrator:

Precautions for access control of the computer

- Secure the computer with a password (for example at Windows start up).
- Choose a complex password: A good password should be at least eight characters long and are not in the dictionary. In addition to letters, it should also include numbers and special characters.
- Do not choose a name or device name for a password (for example "Pentacam").
- Change the password regularly.
- Do not note the password in an accessible location.
- Use different passwords for different users.

- Enable the screen saver and use the option for the necessity of reentering the password when exit the screen saver.
- Choose an adequate time setting for starting the screen saver if software session is inactive (e.g. 10 minutes). Adequate time setting should consider duration of examination, number of patients, time between examinations, use of other devices in the examination room, several user, etc.
- Lock the computer if you are leaving the workstation (shortcut: 'windows logo key' + 'L').

Precautions if the computer is connected to a LAN or internet network

- If you elect to connect the computer to the LAN or internet, you are responsible for ensuring data security.
- Prefer wired connections of the computer to the network.
- If you are using Wi-Fi connections nevertheless, please ensure the usage of adequate security methods (for example WPA2/AES – Wi-Fi Protected Access / Advanced Encryption Standard – with a strong network key).
- The usage of a firewall (software or hardware) is recommended.
- Heed the instructions for integration into an IT-Network [sec. 22.5, page 83](#)



Do not use the Myopia Master® with wireless technology, for example with wireless USB (connection between device and computer)

5 Intended Use



Attention

Federal law restricts this device to sale by or on the order of a physician.

Indications for Use

The Myopia Master® is designed to photograph the eye and take Scheimpflug images of the anterior segment to evaluate the thickness of the cornea. The integrated keratometer measures the central radii of the cornea. The integrated ophthalmic refractometer measures the refractive power of the eye. The integrated interferometer measures the axial length of the eye.

The Myopia Master® may only be used for the purpose described in this instruction manual.

➔ Heed the safety instructions listed above.

Intended medical indication

The Myopia Master® can be used by physicians, opticians and optometrists to support myopia management.

Contraindication

none known

Possible side effects

none known

Intended users

Make certain that the Myopia Master® is used exclusively in clinics and by clinical persons or eye specialists (trained staff etc.).

- who can guarantee proper handling due to their knowledge, training and practical experience.
- who have been instructed by OCULUS staff or an authorized dealer before the initial operation.

Patient group

Children from 3 years up to geriatric patients. No restrictions on weight and health status. The patient must be awake and able to understand and see a fixations object.

6 Transport to Installation Location

The transport and storage conditions see [sec. 18, page 67](#).

- Wait approx. 3-4 hours after transport before operating the Myopia Master®. Extreme temperature changes from cold areas to warm rooms can cause condensation on the optical components.



Note

Equipment damage due to incorrect transport and improper storage

- Avoid shocks and vibration.
- Avoid contamination, high temperatures and humidity.

- Transport the Myopia Master® professionally.
- Store the Myopia Master® according to the storage conditions.
- Avoid placing near radiators and moisture.



Note

- Keep the packing material. You can then ship or transport the unit in the proper manner for any servicing or repairs that may arise. You can thus avoid unnecessary damage and costs.

7 Device Description

7.1 Overview of Device Components



1 Gauge head

2 Printout slot

3 Display

Fig. 7-1: Device components

4 Control Wheel

5 Sliding plate

6 Joystick

7 Function keys

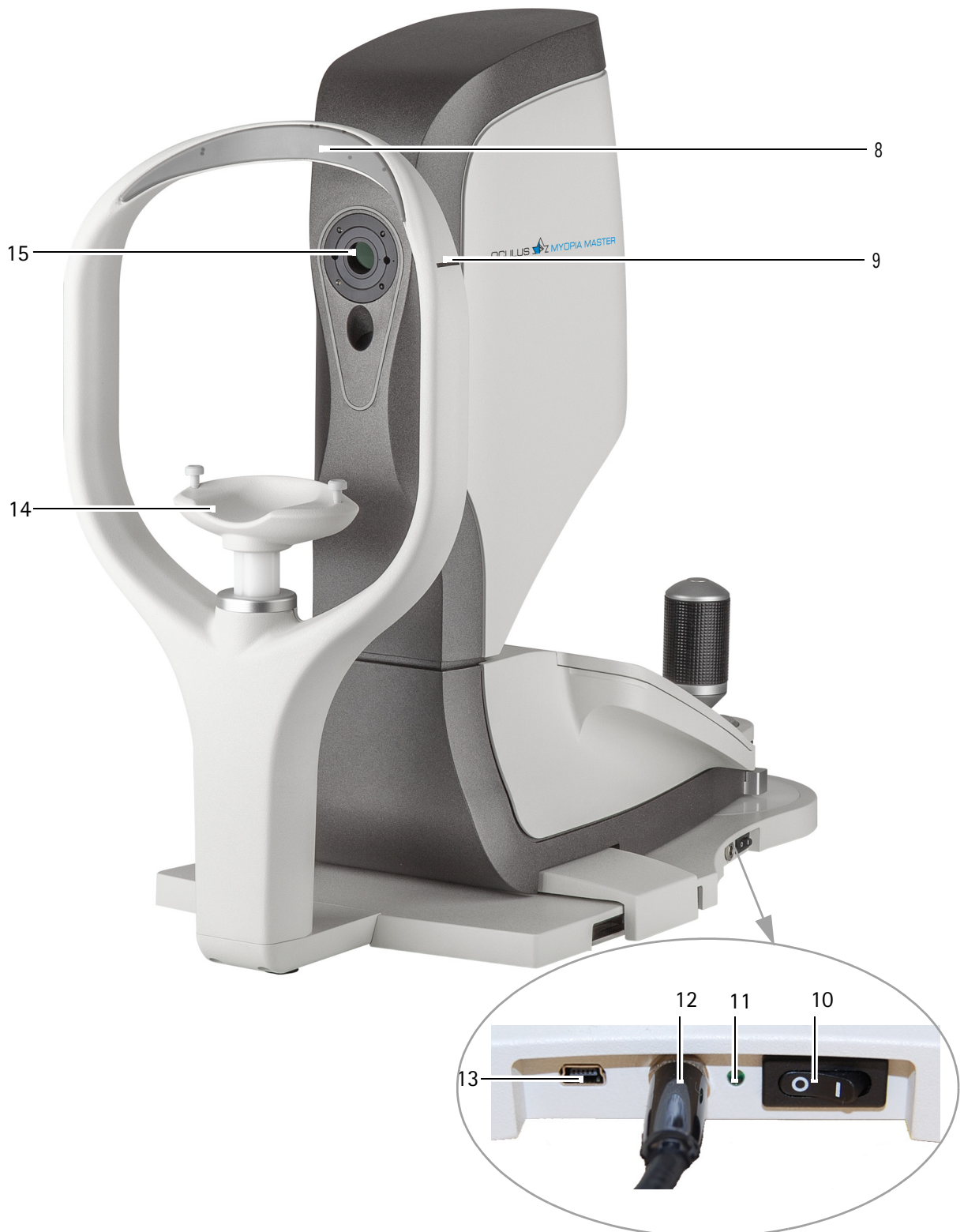

- | | | | | | |
|----|----------------------------|----|------------------|----|---|
| 8 | Head rest | 11 | Control LED | 14 | Chin rest |
| 9 | Marking for the eye height | 12 | Mains connection | 15 | Measuring ocular / Patient eyepiece with Keratometer ring |
| 10 | On/Off Switch | 13 | USB port | | |

Fig. 7-2: Device components

7.2 Mode of Operation of the Myopia Master®

The Myopia Master® combines different measuring functions in one unit.

Auto-Refractometer

An infrared light source projects measuring light onto the retina of the eye from where it is reflected back to the shutter location. Sensitive sensor chips, or CCD cameras now register the deviation of the reflected light from the shutter location. The deviation depends on the ametropia. From that, an integrated microcomputer calculates the ametropia in D, based on the sphere, cylinder and cylinder axis position.

Keratometer

To determine the curvature of the cornea, a reflected image of the cornea is captured by a camera sensor and is measured.

The reflection of test marks and of a ring is used as the reflected image. This allows the central radii of the cornea to be determined.

Pachymeter (optional)

The pachymetry principle uses Scheimpflug images of the cornea, which are analysed by a built-in computer.

600 Absolute data points are evaluated with the Scheimpflug images. The measuring range lies on a 4 mm slit through the apex.

The slit light illuminates a sectional plane from the front surface of the cornea to the back surface. The transparent cells of the cornea scatter the slit light such that the sectional plane appears as if it were self-luminous. This is captured at an angle of 45° through the pupil by a camera, whereby the image plane of the camera is also tilted 45° to the optical axis of the camera lens, in order to sharply focus the light-scattering cornea plane onto the image plane of the camera (Scheimpflug image).

Due to this arrangement, sharp sectional images of the cornea can be attained.

Axial length

The axial length of the eye is measured and displayed by interferometry. The Myopia Master® measures six times the axial length of the patient's eye.

Applied parts



1 Head rest

2 Chin rest

Fig. 7-3: Applied parts

8 Set up and Connection

8.1 Initial Start-up

Before you can operate the Myopia Master® for the first time, you must

- set it up and adjust it
- get trained



Attention

Incorrect measurements / equipment damage due to a lack training

- Before first use: Let OCULUS or an authorized dealer train you in the operation of the Myopia Master®.

Incorrect measurements / equipment damage due to incorrect set-up

- Before the first use, make sure the installation and connection of the "Myopia Master®" examination area is completed by our service or by a professional authorized by OCULUS.
-



Note

- Do not expose the Myopia Master® to any vibrations, shocks, contaminants, moisture, or high temperatures.
 - Handle the optical device with care.
-

8.2 Set-up Jobs for Initial Start-Up

- Wait approx. 3-4 hours after transport before operating the Myopia Master®. If the Myopia Master® was stored in a cold room or vehicle during the cold time of the year, a significant change in temperature may cause condensation to appear on optical parts of the Myopia Master®.
- Check if the transportation safety device is unlocked, [sec. 8.3.2, page 20](#).

8.3 Adjustments after an in-house transport



Note

Equipment damage due to incorrect lifting

If the Myopia Master® is lifted only by the measure head, it can break off.

→ Grab the Myopia Master® from below and the head rest to lift it.

8.3.1 Device set-up

- Place the Myopia Master® on a level surface.
- Place the Myopia Master® so that no direct light can effect the measurement.
- Set up the Myopia Master® so that the power plug is easy to access. That way, you can easily disconnect it from the power supply for any repairs or maintenance work.
- Make sure the examination is free from light reflections. To achieve this, darken the examination room.
- Avoid shocks and vibration.
- Avoid contamination, high temperatures and humidity.

8.3.2 Unlock transport safety device

During transport the Myopia Master® is secured with a transport safety device. This must be unlocked before use.

- ➔ Open the cover with the display.



Fig. 8-1: Open the cover with the display

- ➔ Unlock the transport safety device if it is locked (1).

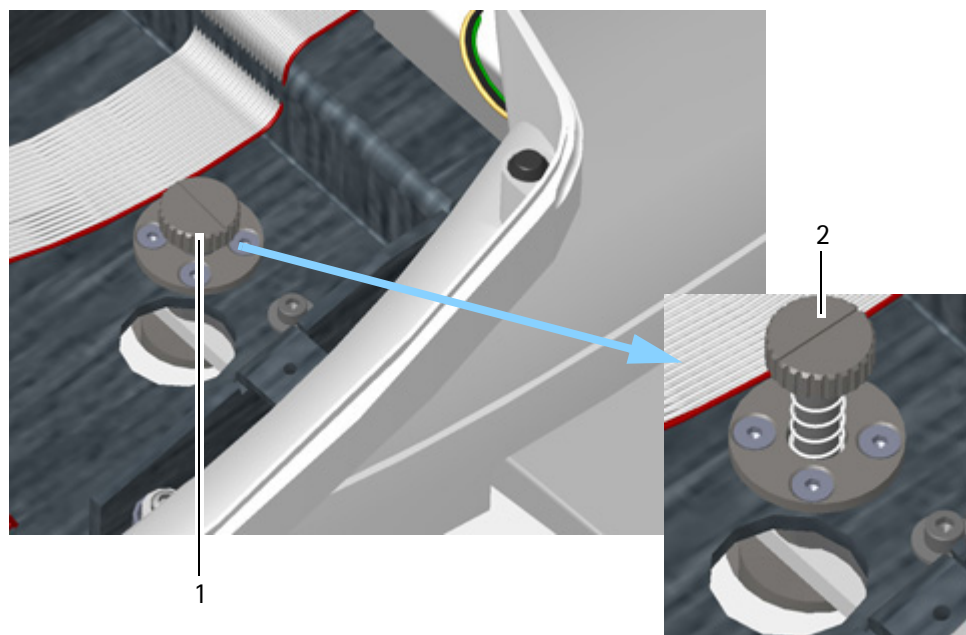

1 "Locked" position

Fig. 8-2: Unlock transport safety device

2 "Unlocked" position

- ➔ Press down gently on the transportation safety device and turn it counter-clockwise to the "unlocked" position (2). The spring will push the transport safety device up.
- ➔ Close the cover with the display, [fig. 8-1, page 21](#).

8.4 Electrical Connection



Caution

Electrical safety hazard

- Do not use the Myopia Master® adjacent to or stacked with other equipment.
- If you have to use the Myopia Master® adjacent to or stacked with other equipment, verify the correct operation of the Myopia Master®.
- Only use the power adapter listed in the list, [sec. 22.1, page 73](#).
- Only use a power cord which meets the requirements of IEC 60227-1, type H05VVH2-F (type 53), minimum 0,75 m² and IEC 60320-1, type C7.
- If you use a multiple socket outlet to connect the Myopia Master®: Use a multiple socket outlet that complies with the requirements of IEC 60601-1.
- Do not place the multiple socket outlet on the floor.
- Do not use more than one multiple socket outlet.
- Plug only the Myopia Master® and the computer that is being used with the unit (if applicable) into the multiple socket outlet.



Fig. 8-3: Connection

- Connect the device to the power supply using the power cable provided, see [sec. 22.1, page 73](#).



Note

Risk of equipment damage due to incorrect connection

If you do not connect the Myopia Master® properly, and the connection is live, the unit can be damaged within a short period of time.

- Do not use excessive force when connecting the electrical plug.
- Pay attention to the specifications on the nameplate.

If the electrical plug is damaged, contact our service department or an authorized dealer to repair the damage.



Caution

Risk of incorrect measurements/equipment damage due to unauthorized personal

- Ensure that only an expert, authorized by OCULUS
 - connects the computer.
 - updates the firmware.

Risk of incorrect measurements/equipment damage due to incorrect connection

Each connection of a Myopia Master® with a computer could introduce risks for patients and operators, which are not described in this manual.

- Ensure the safety of the patient and the operator and ensure the functionality of the Myopia Master® and the connected computer.

- Connect the device to your computer/laptop using the USB port, with a USB cable with an USB FS MED-Isolator for maintenance and service purposes only.

9 Operation

- Wait approx. 3-4 hours after transport before operating the Myopia Master® for the first time. Extreme temperature changes from cold areas to warm rooms can cause condensation on the optical components.

9.1 Switching On



- Turn on the Myopia Master® with the On/Off Switch (position I). The LED lights up green.

9.2 Switching Off

- End the current session.
- Turn the Myopia Master® off with the on/off Switch (position 0).



Caution

Risk of electric shock if the Myopia Master® is not completely disconnected from the mains for transport, cleaning, maintenance, disinfection and repair.

- Turn the Myopia Master® off.
- Pull the power plug before cleaning. When disconnecting electrical connections, pull on the respective plug and not on the cable itself.

9.3 Daily Operation

If you move the Myopia Master® to another location, you must position the Myopia Master® so that direct light cannot influence measurements.

- Place the Myopia Master® on a level surface.
- Connect the unit to the mains with the supplied power cable.
- Make sure that the mains voltage is the same as the voltage specified on the rating plate.
- Switch on the Myopia Master® at the On/Off Switch, see [sec. 9.1, page 24](#).

10 Functions of the Control Pad

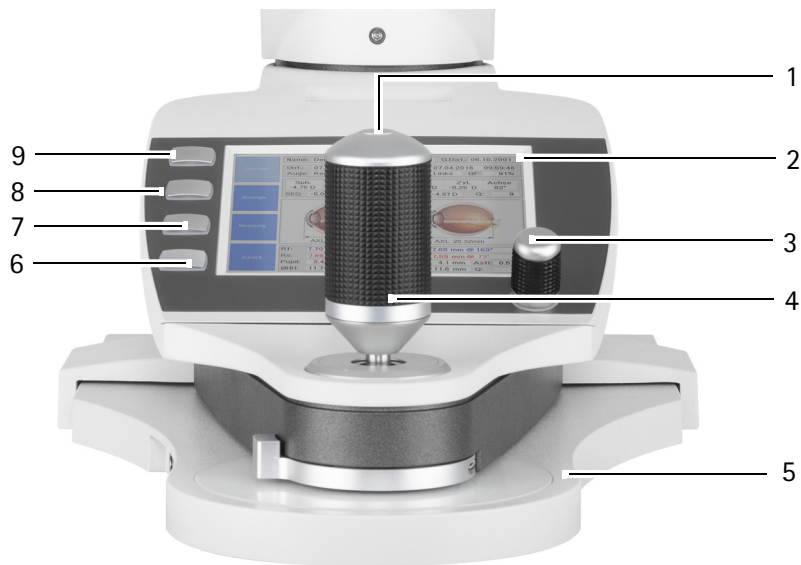

- | | | | |
|---|-----------------|-----|-------------------------------|
| 1 | Joystick button | 4 | Joystick with turning handle |
| 2 | Display | 5 | Compound slide |
| 3 | Control wheel | 6-9 | Functions assigned to buttons |

Fig. 10-1: Functions on the control pad

Component	Function	Operation
Functions assigned to buttons (6 – 9)	Activates the adjacent keypad, depending on the active screen	➔ Press the desired button.
Control wheel (3) 	Changes the respective parameter. Activates the selected parameter	➔ Turn the knob to the left or to the right. The selected parameter is highlighted in blue. ➔ Press the knob downwards. The selected parameter is activated or deactivated.
Joystick (4)	Adjusts the height, distance and alignment to the left and to the right	➔ Move the joystick up, down and to either side, turn it, <i>"Fine Adjustment"</i> , page 35.
Joystick button (1)	Manually triggers the measurement (when the auto measurement release function is switched off)	➔ Press the button.
Display (2)	Shows the program screens and acts as a touch screen	➔ Lightly press on the desired button
Compound slide (5)	Used for rough adjustment	➔ Move the adjusting base until you can see the patient's eye clearly on the screen.

10.1 Touch Screen

Use Touch





If the function is not activated:

→ Enable the checkbox in "Setting 2/5" ([sec. 15.2, page 53](#)),

In addition to the function keys, you can now also use the buttons on the screen, for example you can enable the respective button by gently pressing it on the touch screen.

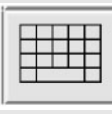
10.1.1 Function Keys on the Touch Screen

Use these function keys to work with the patient data management system.

Button	Function	Button	Function
	Change keyboard		Enter
	Delete character		Return to upper line
	Escape		

11 Preparing Patients Data

Use the patient data management if you want to assign the examinations to a patient or want to save them long-term.

- In that case, enter the patient's name and date of birth before you conduct the measurement.

11.1 Entering new Patients (touch screen)

- To input a new patient, press the button [Patient] in the patient data menu.

The following screen appears:

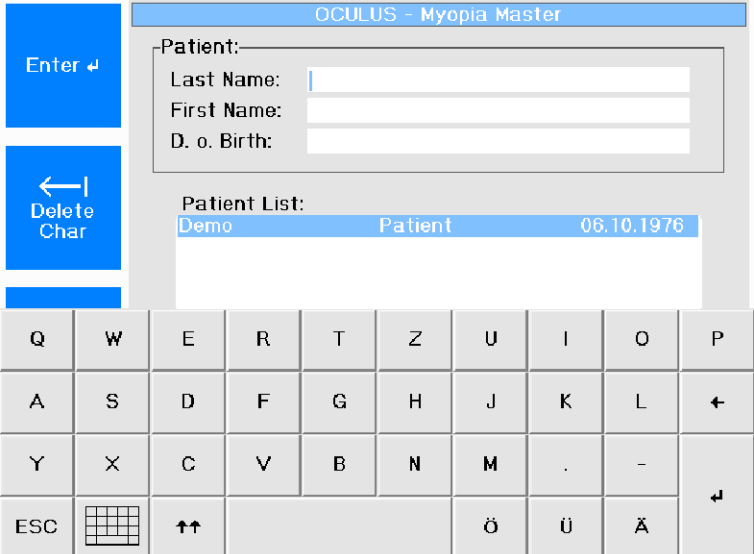

OCULUS - Myopia Master										
Patient:										
Last Name:		<input type="text"/>								
First Name:		<input type="text"/>								
D. o. Birth:		<input type="text"/>								
Patient List:										
Demo		Patient					06.10.1976			
Q	W	E	R	T	Z	U	I	O	P	
A	S	D	F	G	H	J	K	L	←	
Y	X	C	V	B	N	M	.	-	↵	
ESC		↑↑					Ö	Ü	Ä	

Fig. 11-1: Touch screen keyboard, enter patient data

- Use the touch screen as described in (sec. 10.1, page 26).
 - Enter the patient's last name and first name and confirm.
- In the "D. o. Birth" field, the keyboard changes to a numeric keypad.
- Enter the date of birth and confirm.

A confirmation dialog box appears.

- Select the option "Yes".



Store new Patient ?	
Yes	No

The name of the patient appears in the list.

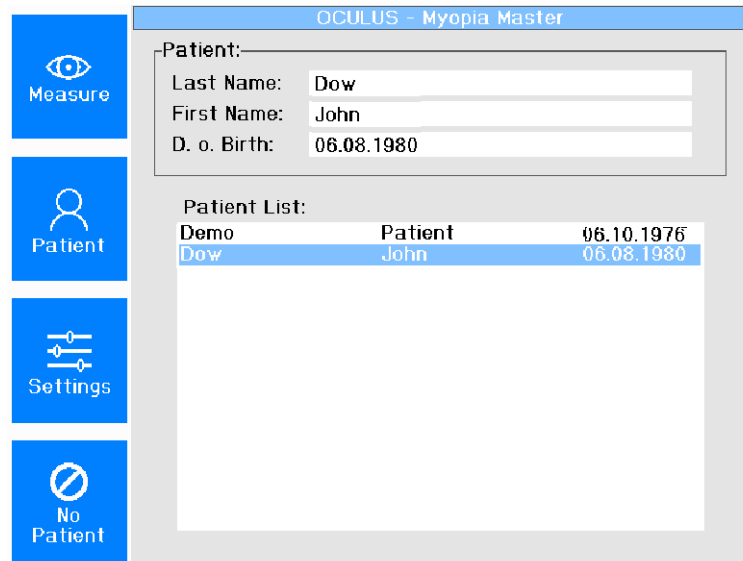

Fig. 11-2: Patient list

➔ Press the [Measure] button to switch to measuring mode.

11.2 Entering new Patients (touch screen deactivated)

- To input a new patient, press the button [Patient] in the patient data menu.

The following screen appears:

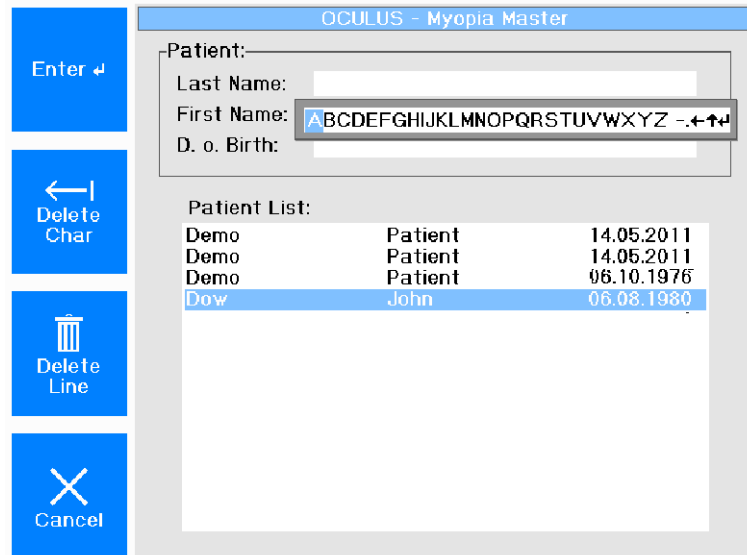

OCULUS - Myopia Master

Patient:

Last Name:

First Name: A B C D E F G H I J K L M N O P Q R S T U V W X Y Z ← → ↻

D. o. Birth:

Patient List:

Demo	Patient	14.05.2011
Demo	Patient	14.05.2011
Demo	Patient	06.10.1976
Dow	John	06.08.1980

Fig. 11-3: Touch screen deactivated

- Select each individual letter by turning the control wheel accordingly.
Confirm each letter by pressing the control wheel.
- Enter the patient's last name.
- To correct an incorrect entry:
Press the [Delete Char] button to delete one character.
Press the [Delete Line] button to delete the whole entry in the field.
Alternatively, you can delete the entered text with the control wheel by selecting the symbol "←".
- After you have entered the full last name, press the [Enter] button.
- Alternatively, you scroll up to the previous line or down to the next line by activating the symbols "↑" and "↓" accordingly.
- Enter the patient's first name and date of birth in the same manner.
- After you have entered the date of birth, confirm by pressing [Enter].
- You will now be asked whether you want to save the new patient data.
- Select the option "Yes".
The name of the patient appears in the list.
- Press the [Measure] button to switch to measuring mode.

11.2.1 Selecting existing Patients

Select patients whose data have already been saved.

- ➔ In the Patient Data Management menu, press the button [Patient].
- ➔ Turn the control wheel to get to the desired entry in the list.

The following screen appears:

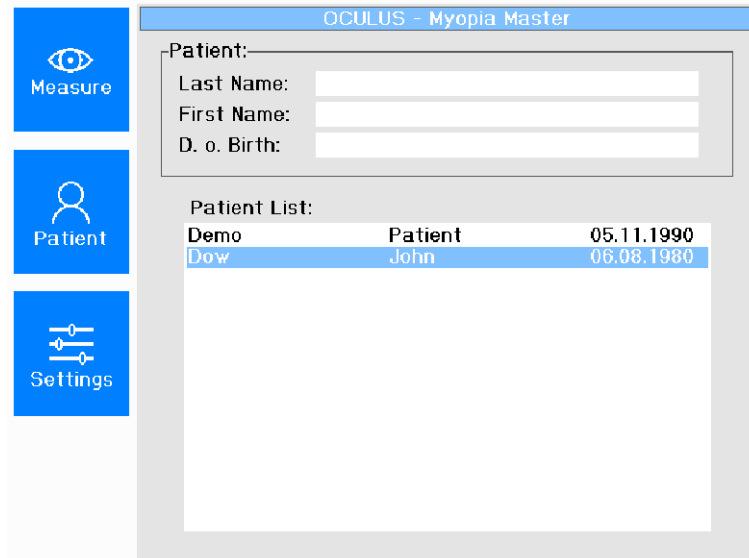

Fig. 11-4: Select a patient

- ➔ Press the [New Exam] button to switch to measuring mode.

11.2.2 Rename a Patient



- ➔ Select the patient that you want to rename.
- ➔ Press the button.
- ➔ Enter the new name in the field "New Name", or enter a new date of birth.
- ➔ Confirm your input.

11.2.3 Delete a Patient or an Examination

If you want to delete a patient or an examination:

- ➔ Select the patient in question.
- ➔ Press the button.

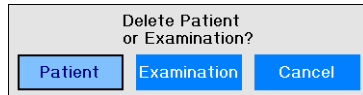

To delete a patient:

- ➔ Select with the control wheel the button [Patient].
- ➔ Press the control wheel.
The data of the patient is deleted.

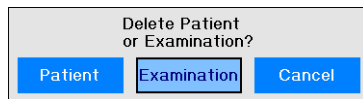

To delete an examination:

- ➔ Select with the control wheel the button [Examination].
- ➔ Select the examination that is to be deleted.
The line for the selected examination appears highlighted in blue.
- ➔ Press the control wheel.
The examination is deleted.

11.2.4 Load an Examination

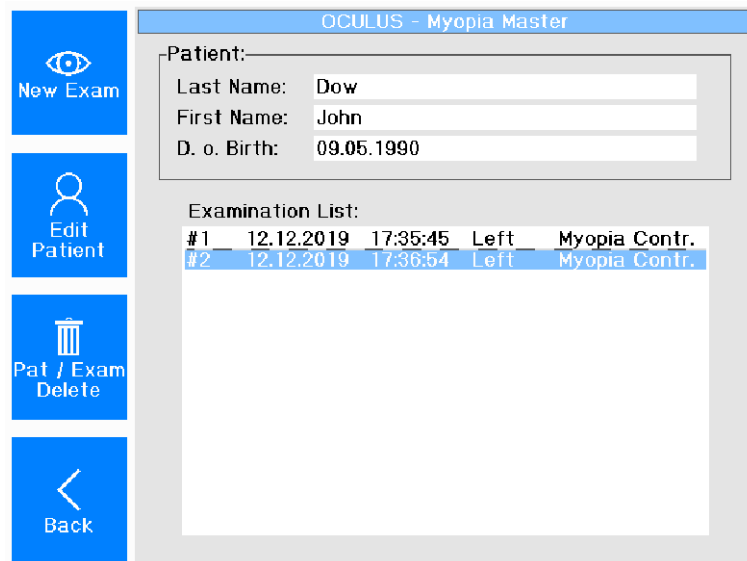

Fig. 11-5: Load an Examination

All examinations can be reloaded and print out at a later date.

If two examinations have already been printed out together, these are also automatically saved together (R+L) and in turn, they are also reloaded together.

If the measurements were not printed out together, the examinations are listed individually (right, left).

The measurements must then be loaded separately, one after the other. Generally, two measurements can only be displayed together when they belong to a single measuring operation.

12 Measuring Procedure



Caution

Risk of incorrect measurement due to incorrect use

- ➔ Before first use: Let OCULUS or an authorized dealer train you in the operation of the Myopia Master®.

A measuring procedure consists of the following steps:

- ➔ Selecting a measuring mode
- ➔ Preparing a measurement
- ➔ Performing a measurement
- ➔ Saving data
- ➔ Completing the measurement

12.1 Selecting a Measurement Mode

The measuring procedure depends on the selected mode:

	<i>Measurement function</i>			
	<i>Keratometry measurement</i>	<i>Refraction measurement</i>	<i>Axial-length measurement</i>	<i>Pachymetry measurement</i>
<i>Myopia</i>	x	x	x	
<i>AR + K</i>		x	x	
<i>AXL</i>			x	
<i>P + AR + K</i> <i>(optional)</i>	x	x		x
<i>PARK + AXL</i> <i>(optional)</i>	x	x	x	x

Measuring mode display:

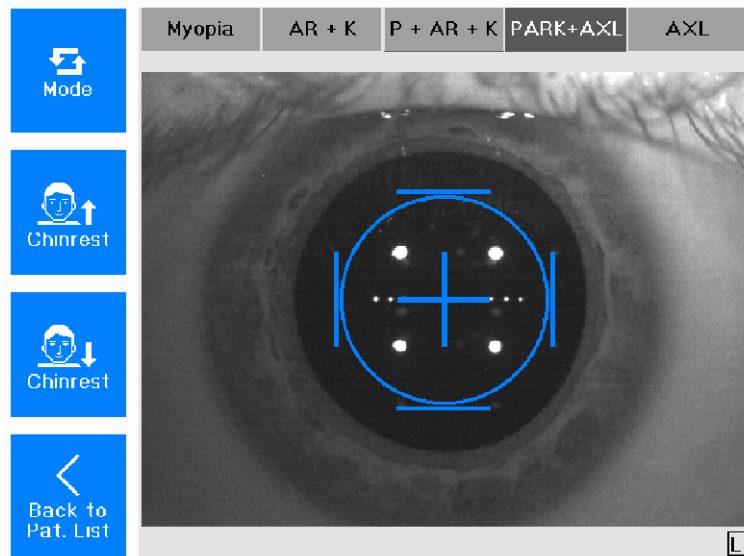

Fig. 12-1: Measuring mode display

- ➔ Press the [Mode] button to change the combination of measuring functions for the individual measurement.
The other parameters that have been selected in "Settings" remain active (*sec. 15, page 51*).
The eye that is being measured is shown at the bottom right, [R] for right or [L] for left.

12.2 Preparing a Measurement

Position the patient and adjust the device before the measurement.

Rough adjustment

- ➔ Check that
 - fresh paper has been put onto the chin rest or that the chin rest has been disinfected
 - the head rest has been cleaned and disinfected after each examination, *sec. 16, page 59*.
- ➔ Do not touch the device and the patient simultaneously.
- ➔ Ask the patient to place his or her head on the chin and head rest.
The eye height marking between the chin rest and the headrest should be located roughly at the centerline of the patient's eye.

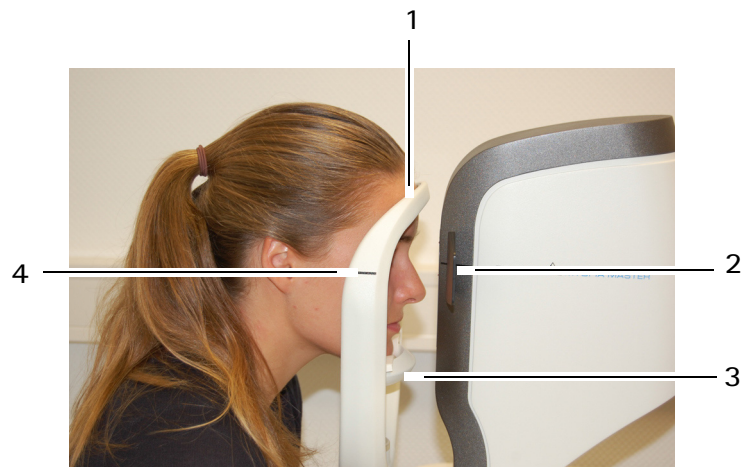

1 Head rest
2 Mark on device
3 Chin rest
4 Mark eye height

Fig. 12-2: Patient position



- ➔ Adjust the chin rest.
In addition, you can also adjust the height of the gauge head by turning the joystick: Turn it clockwise to move the gauge head upwards.
Turn it counter-clockwise to move it downwards.¹

1. If you turn the joystick to the limit stop, the measuring head and the chin rest move in the opposite direction.



Note

When "Eye-tracking" is active, height adjustment takes place automatically.

- ➔ What to say to the patient: "Look into the eyepiece. You will see a balloon. Relax and look at its center".
- ➔ Adjust the compound slide until the image of the patient's eye is sharply focussed on the display.
If necessary: Adjust the height by adjusting the chin rest or the gauge head accordingly.

Fine Adjustment

- ➔ Make any fine adjustments required based on the information in the adjustment window. To do this, move or turn the joystick in the specified directions:

Example:

- ➔ Turn the joystick counter clockwise.

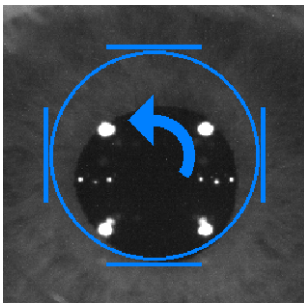

Arrow	Camera movement	Joystick movement
➔	right	Move the joystick to the right
←	left	Move the joystick to the left
↑	forward	Move the joystick towards the patient
↓	back	Move the joystick away from the patient
↻	up	Rotate the joystick clockwise
↻	down	Rotate the joystick counter-clockwise

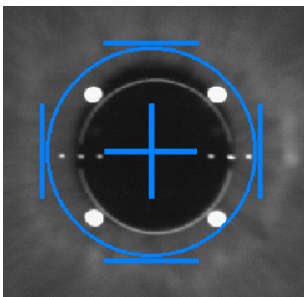

When the position has been reached accurately enough, a cross appears in the center of the ring that is bordered by four bars.
The Myopia Master® will automatically begin measuring. Alternately you can start the measuring procedure manually.

Manual measurement:

- ➔ Initiate the measurement by pressing the joystick button.



Note

In the measuring procedure described here, the relative measuring functions "Myopia" are activated.

First the central corneal radii are measured, then the refraction is performed followed by the axial length measurement.

Furthermore, "Eye-tracking" and "Auto-release" are standardly activated.

At the bottom of the screen, you can see whether measurements have already been taken and saved for the respective eye.

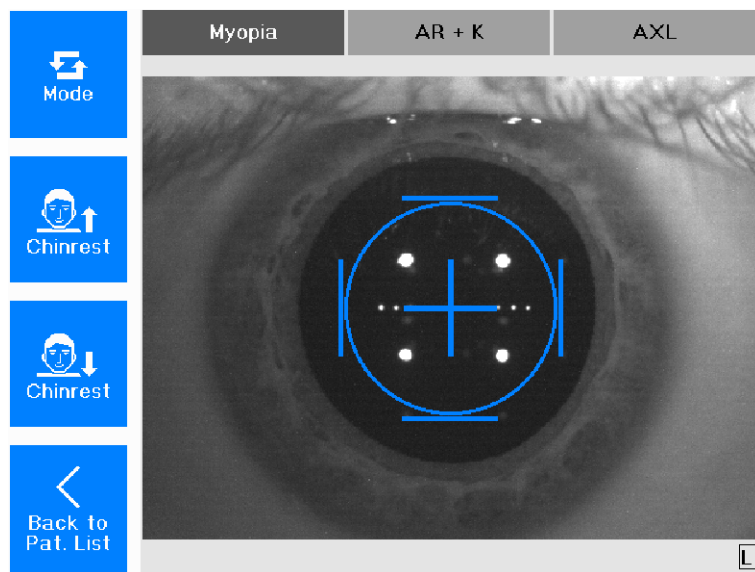



Fig. 12-3: Measuring mode

If the symbol appears at the bottom right or left :

The right or the left eye has already been measured.

The respective measurement can be found in the memory.

➔ Select the appropriate eye to load the examination that was just conducted.

Clear

To delete the existing examinations from the memory, press this button.

12.3 Myopia measurement and results

The measurement mode is preset to "Myopia".

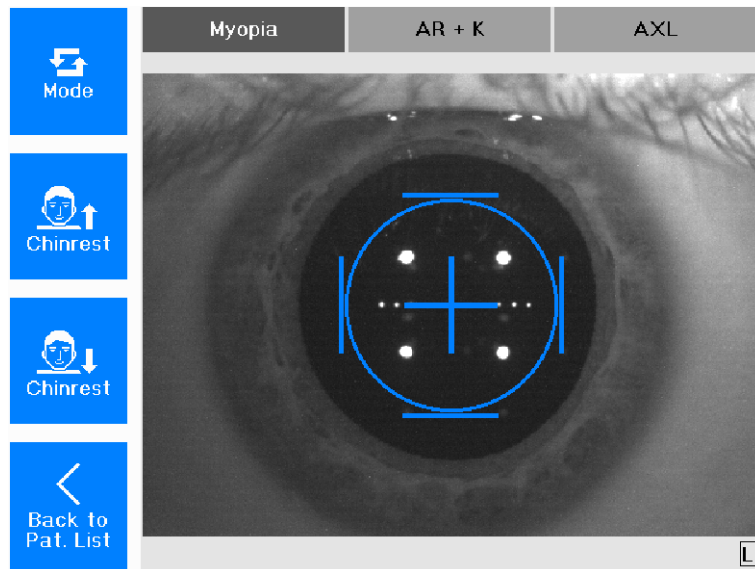

Fig. 12-4: Measuring mode

These steps belong to a complete myopia measurement

- central cornea radii (K)
- objective refraction (AR)
- axial length (AXL)

12.3.1 Myopia Overview Display

The measured values of the myopia examination are displayed in the overview display.

Measure	Name: Dow, John		DoB: 05.08.2012	
	Exam: 13.12.2019 15:19:51		Exam: 13.12.2019 15:20:39	
Display (1/5)	Eye: Right		Eye: Left	
	Sph.	Zyl.	Axis	
Print	+3.63 D	-3.45 D	11°	
	SEQ: 1.90 D	Q: 8		
Back	AXL: 22.25 mm		SNR: 19.0	
	K1: 8.12 mm @ 8°		K1: 7.99 mm @ 179°	
	K2: 7.61 mm @ 98°		K2: 7.56 mm @ 89°	
	Pupil: 4.6 mm Astig: 2.7 D		Pupil: 3.5 mm Astig: 2.3 D	
	WTW: 11.7 mm Q: 7		WTW: 11.6 mm Q: 7	

1 Patient and examination data

2 Refraction values

3 AXL images

4 Keratometry values

Fig. 12-5: Myopia overview display



➔ Press the button to change to the prognosis display.

12.3.2 Myopia Results

After performing the measurement the following display appears.

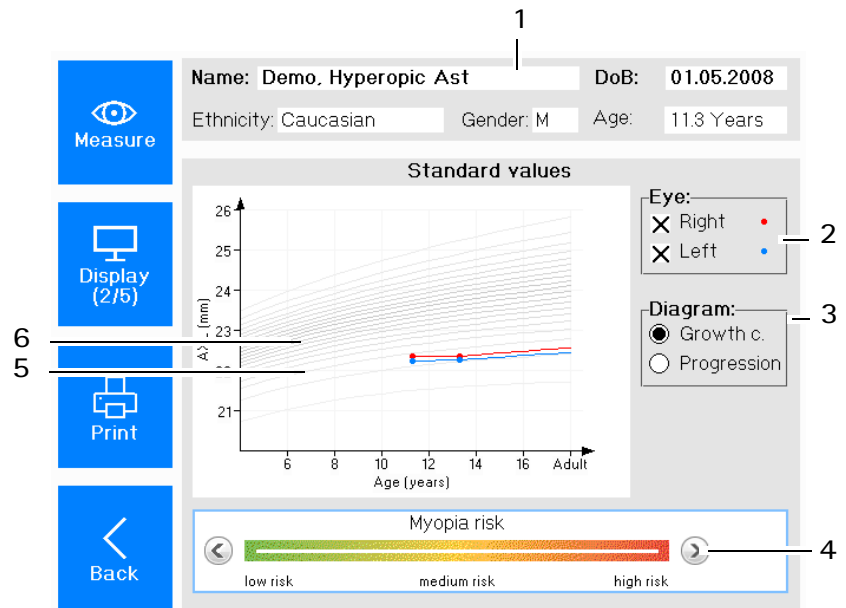

- | | |
|---|---|
| 1 Patient and examination data | 4 Risk assesment |
| 2 Colour for examined eye | 5 Measurement values of the patients age |
| 3 Selection of growth curves or progression | 6 Progressive representation of axial lengths and objective refraction values |

Fig. 12-6: Diagram (here: growth curves)

The display shows the measurement values of either a single or both eyes. They are colour coded (5).

You can choose between the display of the growth curves and the progression, i.e. the development over the time (3).

Growth curves

If the "Growth curves" display is selected, the graphic shows the measured axial length values depending on the age of the patient. The grey lines reflect the percentile curves.

Progression

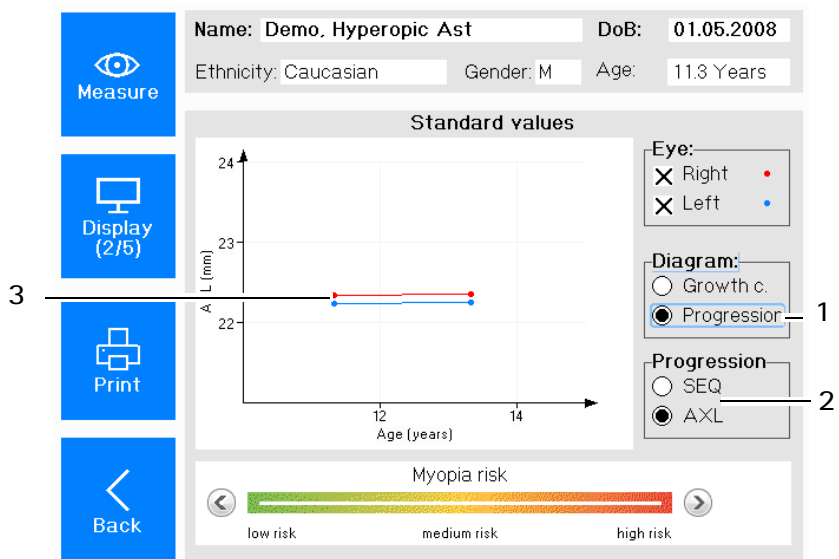

- 1 Selection of progression display
- 2 Selection of the displayed measured value
- 3 Measured values according to patients age
- 4 Risk assessment

Fig. 12-7: Diagram (here: progression)

When the "Progression" display is selected, the graphic shows the development of the selected measured value over time as a function of the patient's age. You can choose between the display of the following measured values:

- Spherical equivalent (SEQ)
- Axial length (without percentile curves)

Regardless of the display selected, you can manually set the risk of myopia using the colour bar (4).

➔ Press the button to change to the risk factors display.

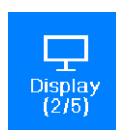

The following display appears.

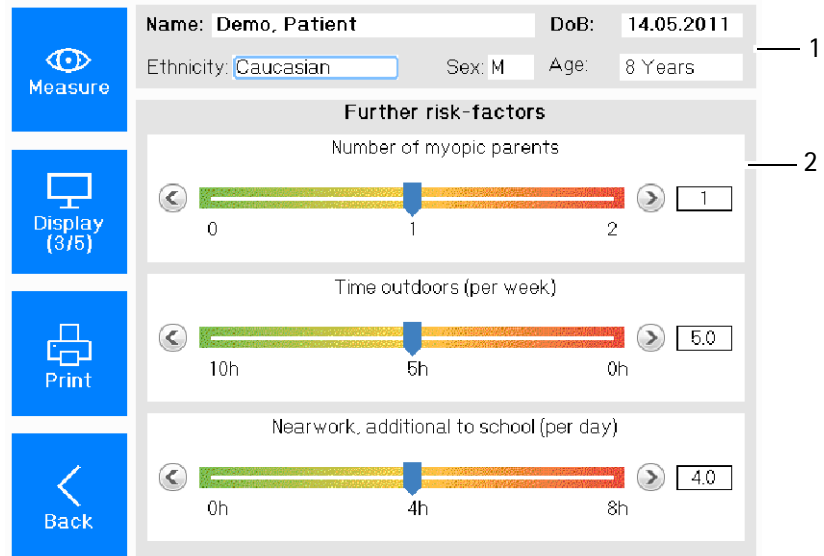

1 Patient and examination data

2 Further risk factors

Fig. 12-8: Risk factors display

The questionnaire gives you a brief risk assessment. The risk is classified according to scientific studies.

- ➔ Ask the patient about his/her:
 - ethnicity
 - number of myopic parents
 - gender
 - time outdoors (per week)
 - near work, additional to school (per day)
- ➔ Answer the respective question by adjusting the slider to the corresponding value.
 You can therefore use the control wheel and confirm by pushing.
 Alternatively use the arrow button to the right for increasing or to the left for decreasing the values.
- ➔ Press the button to change to the AR + K display.



12.3.3 Refraction Results

After performing the measurement the following display appears.

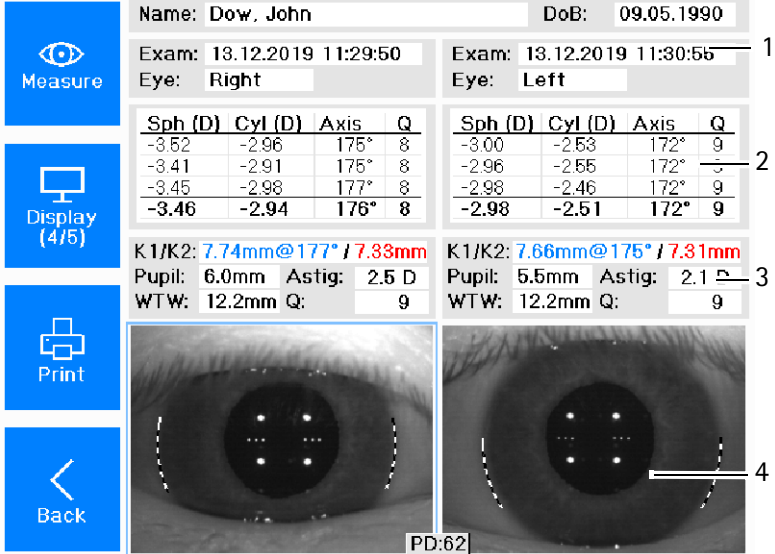

The screenshot shows a software interface with a left sidebar containing icons for Measure, Display (4/5), Print, and Back. The main display area is divided into several sections:

- 1 Patient and examination data:** Name: Dow, John; DoB: 09.05.1990; Exam: 13.12.2019 11:29:50 (Right Eye); Exam: 13.12.2019 11:30:56 (Left Eye).
- 2 Refraction values:** Two tables showing Sph (D), Cyl (D), Axis, and Q for both eyes. The right eye table shows values: (-3.52, -2.96, 175°, 8), (-3.41, -2.91, 175°, 8), (-3.45, -2.98, 177°, 8), and (-3.46, -2.94, 176°, 8). The left eye table shows values: (-3.00, -2.53, 172°, 9), (-2.96, -2.55, 172°, 9), (-2.98, -2.46, 172°, 9), and (-2.98, -2.51, 172°, 9).
- 3 Keratometer:** K1/K2: 7.74mm@177° / 7.33mm (Right Eye); K1/K2: 7.66mm@175° / 7.31mm (Left Eye); Pupil: 6.0mm Astig: 2.5 D (Right Eye); Pupil: 5.5mm Astig: 2.1 D (Left Eye); WTW: 12.2mm Q: 9 (Right Eye); WTW: 12.2mm Q: 9 (Left Eye).
- 4 Iris images:** Two grayscale images of the eyes with dashed white circles indicating the measurement area. A label 'PD:62' is visible at the bottom of the images.

1 Patient and examination data

2 Refraction values

3 Keratometer

4 Iris images

Fig. 12-9: AR + K overview display

Refraction Values (2)

The sphere, cylinder, axis position and quality values are displayed in this field.

The refraction values are measured three times. The mean value is displayed in the fourth line.

Q-value:

If the field has a white background (9-7) - the measuring results are good.

If the field has a yellow background (6) - the measuring results are critical; repeat the measurement, if necessary.

If the field has a red background (≤ 5) - repeat the measurement.

Keratometer Values (3)

- K1/K2: Horizontal/vertical radius of curvature in the center
blue: flat meridian
red: steep meridian
- Pupil: Size of pupil
- Astig: Astigmatism of cornea in the center
- WTW: (white-to-white) Cornea diameter or iris diameter.
- Q-value:
If the field has a white background (9-7) - the measuring results are good.

If the field has a yellow background (6) - the measuring results are critical; repeat the measurement, if necessary.
 If the field has a red background (≤ 5) - repeat the measurement.

Camera image (4)

The cornea or the edge of the iris is marked in the camera image.

12.3.4 Axial length results

After performing the measurement the following display appears.

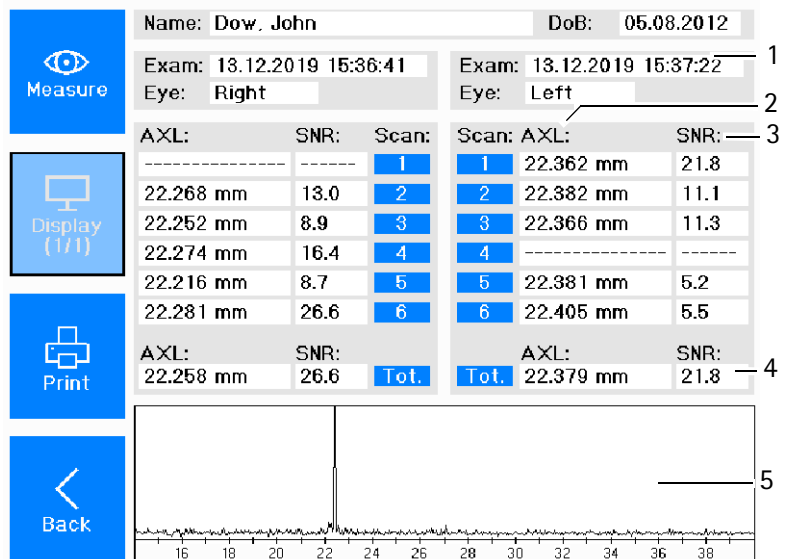

- 1 Patient and examination data
- 2 AXL values
- 3 SNR ratio
- 4 Highest SNR value
- 5 Signal to noise ratio graph

Fig. 12-10: AXL overview display

The axial length values for one or both eyes are shown in the table (2). The corresponding signal to noise ratio (SNR) (3) is listed. A specially averaged axial length and the highest SNR (4) are displayed. Furthermore the SNR is shown in a graph (5).

12.3.5 Pachymetry results (optional)

After performing the measurement the following display appears.

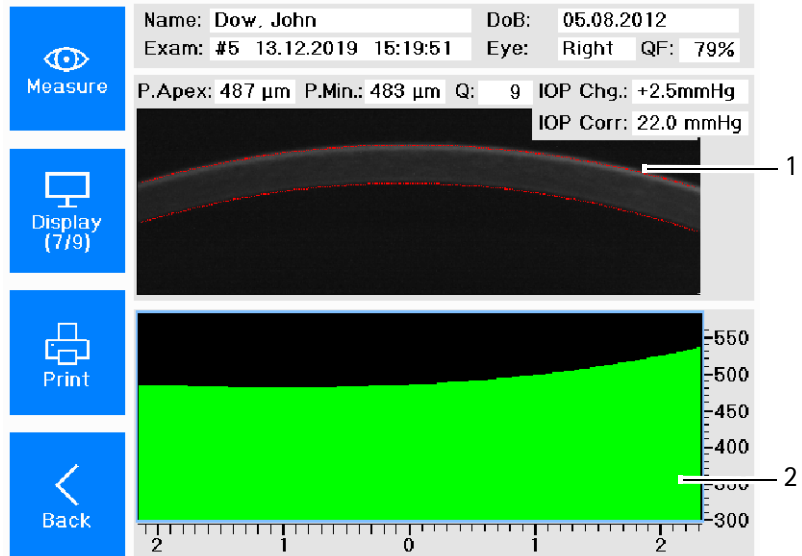

1 Scheimpflug image

2 Corneal thickness range

(Measuring range: horizontal 4mm section through the apex)

Fig. 12-11: Overview Pachymetry

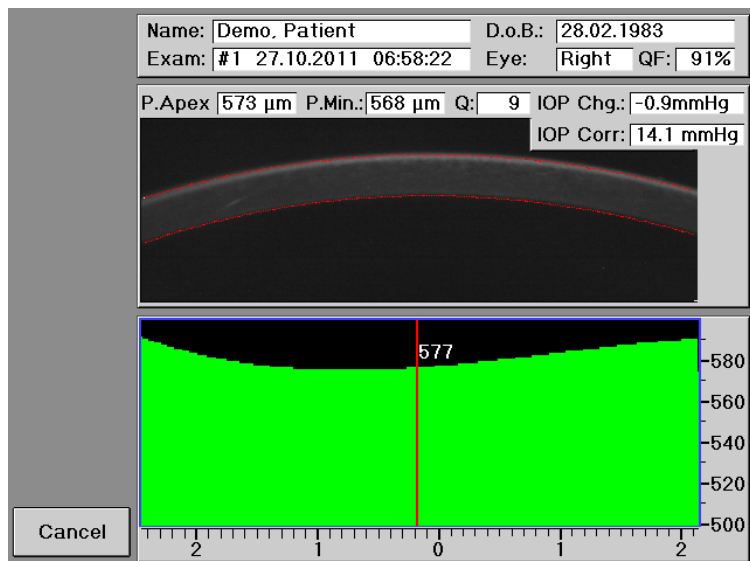

- ➔ Press in the "Corneal thickness progression" field on the touch screen.
The device shows you the exact location of the cornea at the selected spot.
- ➔ You can move the pointer to the left or to the right on the touch screen with the rotary knob.

12.3.6 Ending the measurements

- ➔ Print and/or save the data, [sec. 12.4, page 44](#).

12.4 Printing and Saving Examinations

After performing the measurement of the myopia the following display appears.

Measure	Name: Dow, John		DoB: 05.08.2012	
	Exam: 13.12.2019 15:38:52		Exam: 13.12.2019 15:39:21	
Display (1/5)	Eye: Right		Eye: Left	
	Sph.	Zyl.	Axis	
Print	+0.16 D	-1.22 D	20°	
	SEQ: -0.45 D	Q: 9		
Back	K1: 9.66 mm @ 6°		K1: 8.98 mm @ 1°	
	K2: 8.40 mm @ 96°		K2: 8.10 mm @ 91°	
	Pupil: 5.9 mm Astig: 5.3 D		Pupil: 5.4 mm Astig: 4.1 D	
	WTW: 12.7 mm Q: 5		WTW: 12.3 mm Q: 6	

Fig. 12-12: Display with print button

12.4.1 Printing



➔ Press the [Print] button to print out the examination results.



Note

The measurement is automatically saved if you entered a new patient (sec. 11.1, page 27) prior to starting the measuring process.

When printed out, each measurement is automatically temporarily saved to the exam nr. memory ("Saving data by Exam no. memory", page 45).

The different measuring processes are outlined briefly in the chapter "Chronology of Different Measuring Processes" (sec. 13, page 46).

Save the examination retroactively if you did not set up a new patient (sec. 13.2, page 47) prior to executing the measuring process.

12.4.2 Saving an examination

There are two different ways of saving an examination:

- Exam nr. memory
- Patient Data Management

Saving data by Exam no. memory

After printing, each examination is automatically saved in the exam no. memory and can be retrieved from there later.

A maximum of 100 examinations can be stored in the exam nr. memory, after which the first measurement that was saved is overwritten again. If you want to save examinations long-term, use the patient data management.

If you want to retrieve a measurement again later, you will find the examination in the exam nr. memory under the exam number that was assigned to it and can thus reload it.

You can retrieve the measurement at a later time using the number [15].

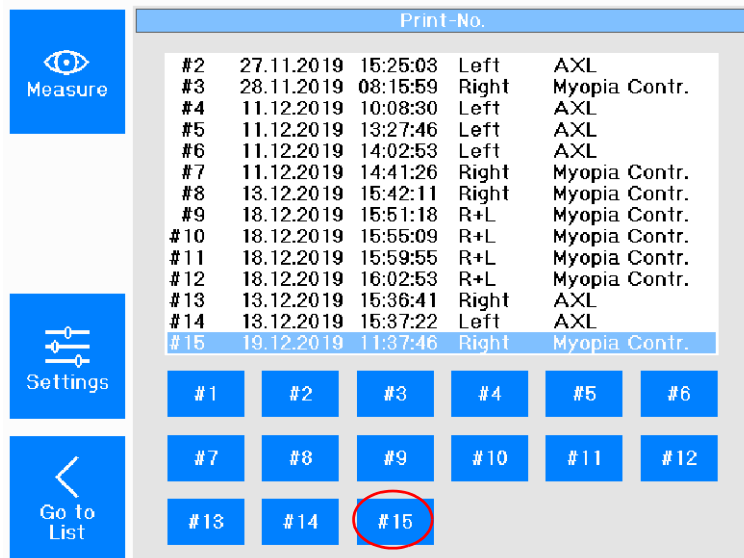
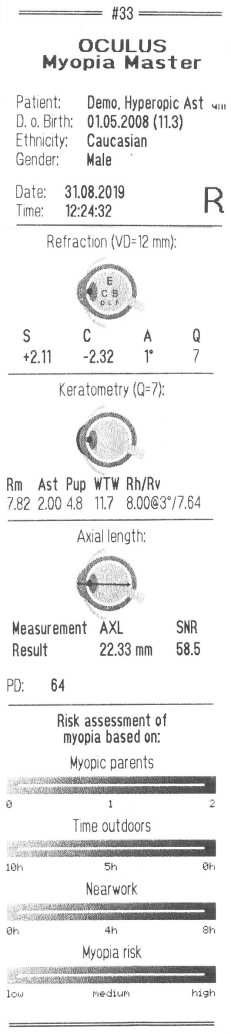

Fig. 12-13: Exam nr. Memory

12.5 Complete measurement



This button is displayed after a measurement has been conducted.

- ➔ Press this button to save the examination data to the patient's record.
- ➔ After each patient remove one of the paper sheets from the chin rest. See also [sec. 16.4, page 63](#).
- ➔ Disinfect the head rest and, if necessary, the chin rest after each patient, [sec. 16.2, page 61](#).

13 Chronology of Different Measuring Processes

The chronology of three different measuring processes is outlined briefly below.

- 1 You enter a patient in the patient data management and then conduct the measurement.
The examination data are automatically saved under the newly entered patient's name ([sec. 13.1, page 46](#)).
- 2 You start directly with the measuring operation and then subsequently save the examination under an existing patient's name. Alternatively, you can also enter a new patient after performing the measuring operation ([sec. 13.2, page 47](#)).
- 3 You perform a measuring operation without saving the examination under a patient's name ([sec. 13.3, page 48](#)).

13.1 Enter Patient + Measure

- ➔ Press the button [Patient] in the patient data management.
- ➔ Create a new patient, as described in [sec. 11.1, page 27](#).
The newly entered patient appears in the list of patients and is highlighted in blue.
- ➔ Start the measuring operation by pressing the [Measure] button.
Press the optional joystick button.
- ➔ Conduct the measurement ([sec. 12, page 33](#)).
When the measuring operation has been completed, the overview screen appears ([fig. 12-5, page 37](#)).
The conducted examinations are automatically saved in the patient data management.
The saved examinations can be viewed again at any time ([sec. 12.4, page 44](#)).

13.2 Saving an Examination Retroactively

- ➔ Start the measuring operation directly.
- ➔ The following screen appears:

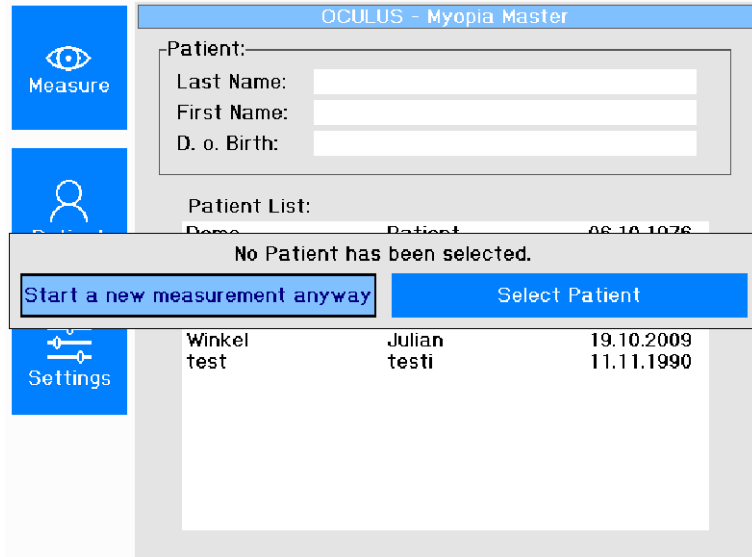

Fig. 13-1: Start a new measurement

- ➔ Select "Start a new measurement anyway".
- ➔ Conduct the measurement (sec. 12, page 33).
When the measuring operation has been completed, the overview screen appears (fig. 12-5, page 37).
- ➔ In the overview screen, press the button [Save to Patient].
The "Patient List" display opens.

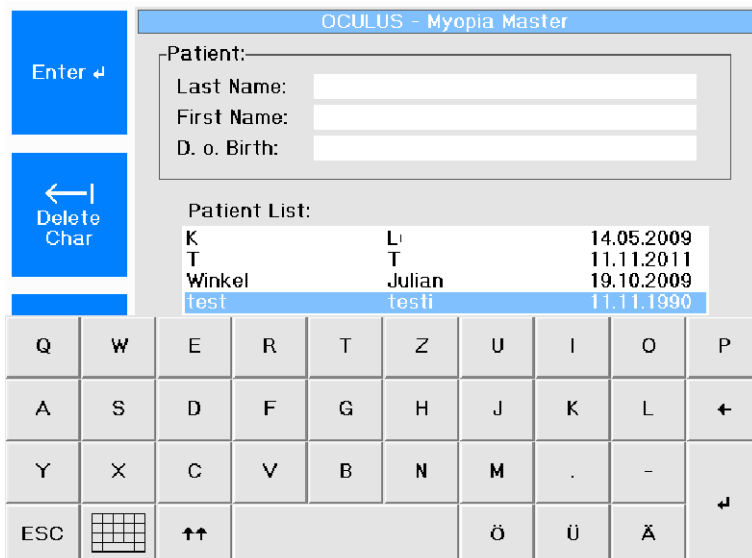

Fig. 13-2: Patient list

- 1 You can enter a new a patient and save the conducted measurement under that patient's name. You must first exit the patient list.
The patient data management is already opened (*fig. 11-1, page 27*).
 - ➔ Create a new patient, as described in *sec. 11.1, page 27*.
The newly entered patient appears in the list of patients and is highlighted in blue.
The conducted examinations are saved in the patient data management.
You can retrieve the saved examinations at any time (*sec. 12.4, page 44*).
- 2 You can select a patient and save the conducted measurement under that patient's name
 - ➔ Exit the character box for entering the patient's data.
 - ➔ Press the "ESC" button on the keyboard.
 - ➔ Select the patient and confirm by pressing the control wheel.
 - ➔ Alternatively use the button "Save to Patient"
The examination data are saved under the selected patient's name.
The saved examinations can be viewed again at any time (*sec. 12.4, page 44*).

13.3 Measuring Without Saving the Patient Data

- ➔ Start the measuring operation directly.
- ➔ Conduct the measurement (*sec. 12, page 33*).
When the measuring operation has been completed, the overview screen appears (*fig. 12-5, page 37*).
Print out the measurement(s) (*sec. 12.4, page 44*).
When printed out, each measurement is automatically temporarily saved to the exam nr. memory ("*Saving data by Exam no. memory*", *page 45*).

14 Reference Measurement

To achieve a high measuring accuracy, the Myopia Master® must be set up

- before conducting the first examination on a patient
- after changing the position of the Myopia Master®

The first reference measurement is performed during setup by OCULUS or an authorized dealer. OCULUS recommends performing a reference measurement once each month.

The reference measurement can be performed easily and quickly using the reference tool.

Required materials

- reference tool, provided
- cleaning agent, see [sec. 16, page 59](#)

Measuring with the reference tool

Prerequisite: the Myopia Master® must be turned on for at least 15 minutes. For the reference measurement, proceed as follows:

- ➔ Remove the cover cap.
- ➔ Thoroughly clean the reference tool before saving reference values with the cleaning agent.
- ➔ Place the reference tool on the chin rest.



Fig. 14-1: Installation of the reference tool

- ➔ Add a new patient, named "reference test" and select "Myopia" or "ARK + AXL".
- ➔ Perform a measuring operation with the reference tool ([sec. 12.3, page 37](#)).
- ➔ Compare the results with the results on the reference tool.



Fig. 14-2: Example: Result on reference tool

The system is now ready for operation.

15 Settings

Choose the default settings for your individual measuring mode.

15.1 Settings 1

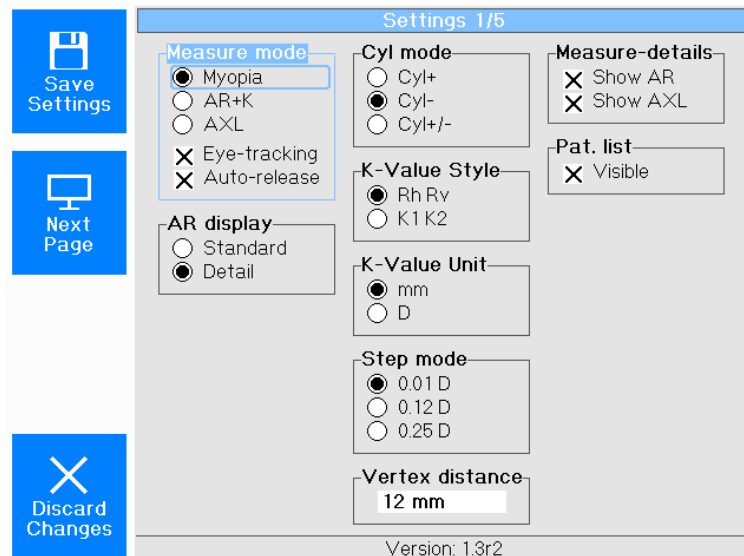

Fig. 15-1: Settings 1

Measuring Mode

You can preset the measuring function combinations here.

Myopia Contr.: Myopia measurement

AR + K: Refraction+Keratometry

AXL: axial length measurement

You also activate or deactivate the functions "Eye-tracking" and "Auto-release" here.

Eye-tracking: Automatic adjustment of the measuring head in y-direction (height).

Auto-release: Automatic triggering of the measuring operation

AR display

In "Standard" mode, the calculated mean refraction is displayed.

"Detail" mode additionally displays the values of the individual measuring steps.

Cyl mode

Select whether plus or minus cylinders are to be used.

When the program is started, this preselected cylinder type is then always active.

K-Value Style

Select the mode for determining how the central radii are to be displayed.

Rh Rv: horizontal / vertical radius

K1 K2: Flat radius / Steep radius

K-Value Unit

The measured curvature of the cornea can either be shown as a radius of curvature in mm, or as the curvature equivalent in diopters.

Step mode

Select the increments in which the diopters of the refraction values are to be rounded.

Vertex distance

Set the cornea vertex distance to which the displayed refraction values are to relate.

Measure-details

Show AR: Activates the refraction display *(fig. 12-9, page 41)*

Show AXL: Activates the axial length display *(fig. 12-10, page 42)*

Pat. list

If the "Visible" checkbox is activated, all patients are displayed with their surname, first name and date of birth. You can deactivate the checkbox e.g. for data protection reasons, then the patient list is empty.

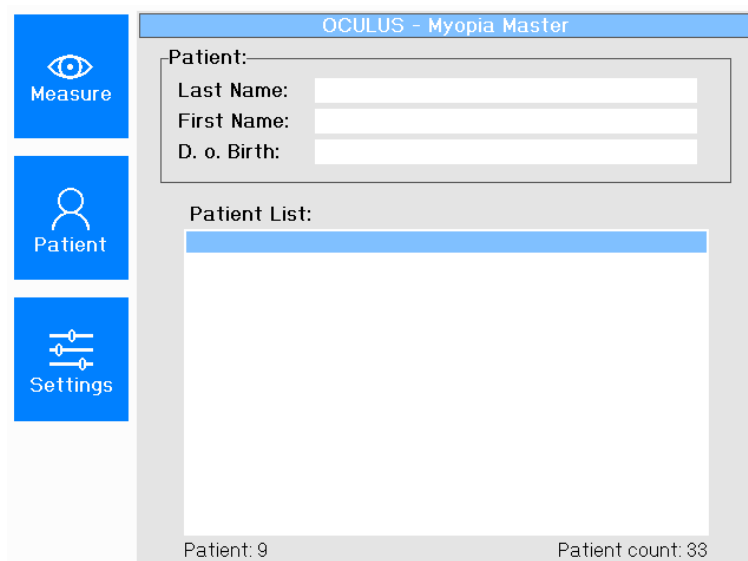

Fig. 15-2: Empty patient list when checkbox is deactivated

15.2 Settings 2

→ On the "Settings 1" screen, press the button [Next Page].

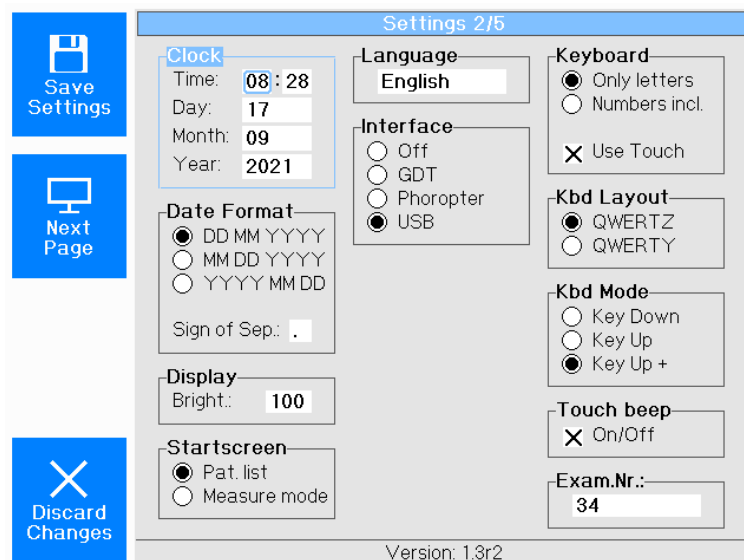

Fig. 15-3: Settings 2

Clock – Date Format

In these two fields, you set the time and the date by turning and pressing the rotary knob.

Display

You can adjust the brightness of the display here.

Startscreen

When the option "Measure mode" is active, you start with the measuring operation directly after switch-on.

When the option "Pat. list" is active, you start with the patient data management directly after switch-on.

Language

Select the on-screen language.

Interface

You can deactivate the interfaces.

If the Myopia Master® is connected to a computer via USB, you need to set the interface settings to "USB".

Keyboard / touch screen / Kbd Layout / Kbd Mode

- In the "Keyboard" field, select the keyboard interface of the touch screen for input of patient data, for example. You activate or deactivate the touch screen function in the "Use Touch" checkbox
- In the "Kbd Layout" field, you select the keyboard layout. QWERTZ stands for the German keyboard layout. QWERTY stands for the American keyboard layout.
- In the field "Kbd Mode", you select the contact control of the touch screen.
 - In "Key Down" mode, the characters are input as soon as you make contact with the touch screen
 - In "Key Up" mode, the characters are input when you stop pressing the touch screen.
 - This is the case in "Key Up+" mode too. However, the entered character is also displayed on the screen:

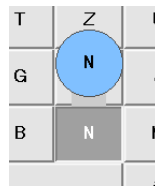

Fig. 15-4: Kbd Mode "Key Up+", Example: The letter N

Touch beep

If the checkbox is activated, then a "peep tone" will sound- when the touch screen is operated.

Exam.Nr.

The "Exam Nr." that appears on every printout for identifications purposes can be reset to zero at any time.

15.3 Settings 3

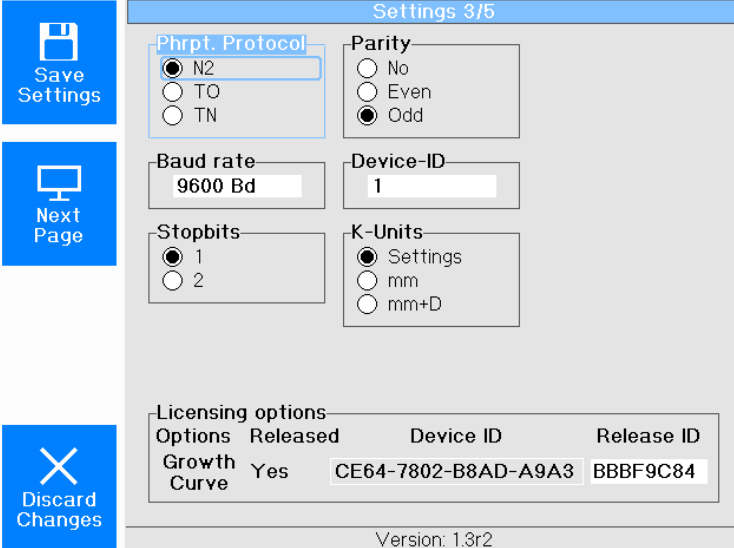

Licensing options			
Options	Released	Device ID	Release ID
Growth Curve	Yes	CE64-7802-B8AD-A9A3	BBBF9C84

Version: 1.3r2

Fig. 15-5: Settings 3

In "Settings 3" the display of growth curves can be activated in the lower area "Licensing options" using the device license "Growth Curve".

- ➔ Contact your OCULUS contact person to acquire a corresponding licence.
- ➔ To activate the growth curves, enter the release ID in the field provided.

15.4 Settings 4

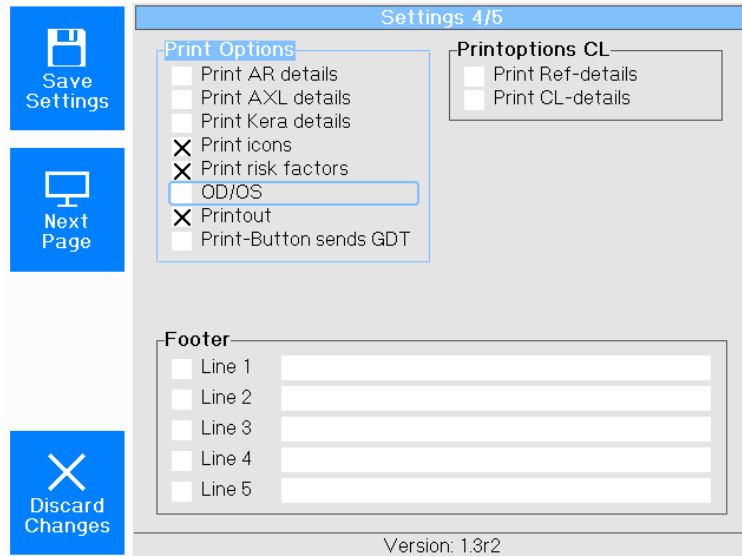

Fig. 15-6: Settings 4

On the "Settings 4" screen, you can individually configure the printout.

Print AR Details

Refraction (VD=12 mm):



S	C	A	Q
+3.22	-3.65	7°	8
+3.44	-3.70	7°	8
+3.43	-3.69	7°	8
+3.35	-3.67	7°	8

Print AR Details: activated

Refraction (VD=12 mm):

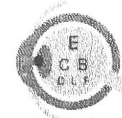

S	C	A	Q
+2.11	-2.32	1°	7

Print AR Details: deactivated

Print Keratometer Details

Keratometry:



Rh: 8.12 mm / 41.6 D @ 6°
 Rv: 7.62 mm / 44.3 D @ 96°
 Rm: 7.87 mm / 43.0 D
 Astig: 2.7 D
 WTW: 11.7 mm
 Pupil: 5.0 mm
 n: a

Print Kera Details: activated

Keratometry (Q=7):



Rm Ast Pup WTW Rh/Rv
 7.82 2.00 4.8 11.7 8.00@3°/7.64

Print Kera Details: deactivated

Print AXL Details

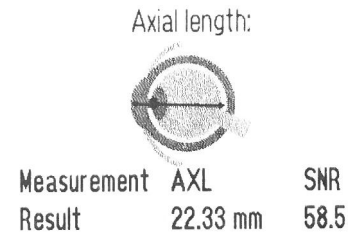
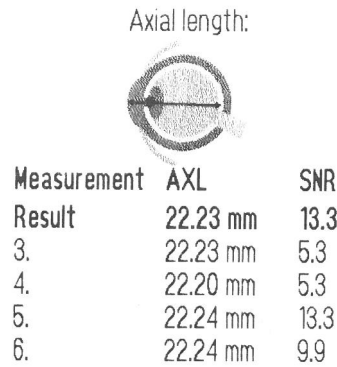

Print AXL Details: activated

Print AXL Details: deactivated

- **Print icons**
Associated icons of the different measurements are also printed out.
- **Print risk factors**
Risk factors are also printed out.

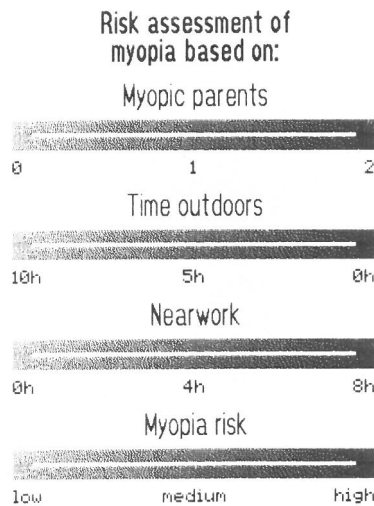

Print risk factors: activated

- **Print Ref Details**
Refraction details (objective / subjective measurement) are also printed out.
- **Footer in the printout**
If you want to include your business or office name on the printout: Enter the appropriate information in the lines provided for that purpose and activate the checkboxes in front of each line.

OD/OS

According to the settings R (right) and L (left) is printed out or OD (oculus dexter) and OS (oculus sinister).

15.5 Settings 5

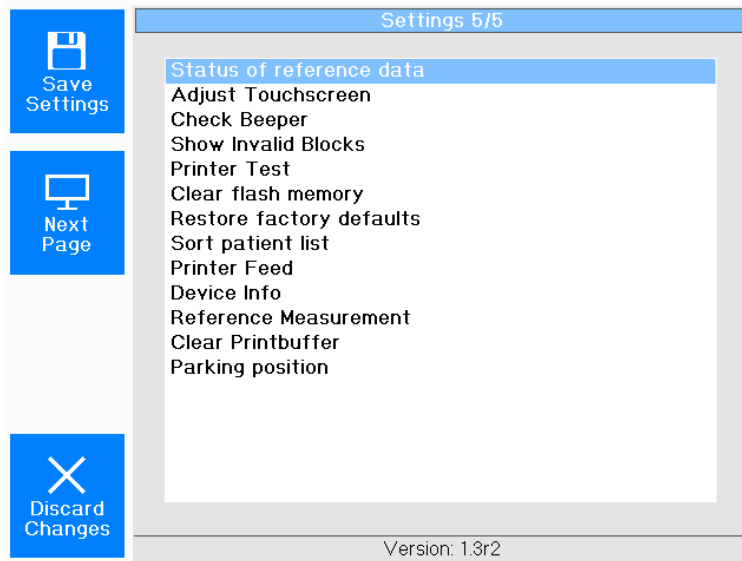

Fig. 15-7: Settings 5

16 Cleaning, Disinfection and Maintenance

This chapter describes how to clean, disinfect, and maintain the Myopia Master®.

Sterilization is not required.

- Always pay attention to the product descriptions and instruction manuals of any materials or products that you use to care for, clean, and disinfect the device and/or its accessories.



Note

Equipment damage due to moisture

- Make sure that no liquid can get into the Myopia Master®.

16.1 Cleaning



Caution

Risk of electric shock if the Myopia Master® is not completely disconnected from the mains for the cleaning.

- Turn the Myopia Master® off, [sec. 9.2, page 24](#).
- Pull the power plug before cleaning. When disconnecting electrical connections, pull on the respective plug and not on the cable itself.

- Do not clean the Myopia Master® with aggressive, chlorinated, abrasive or harsh cleansers.

Required materials:

- Cleaner for plastic surfaces with anti-static effect
- Cleaner for painted surfaces: Mixture of equal parts of alcohol and distilled water, possibly with a few drops of commercial detergent
- Soft, lint-free cloth
- Methanol or pure alcohol or lens cleaner
- Gauze moistened with rubbing alcohol
- Soap solution

Cleaning intervals

- Clean the chin rest and head rest after each examination, clean the housing once a month or if necessary.

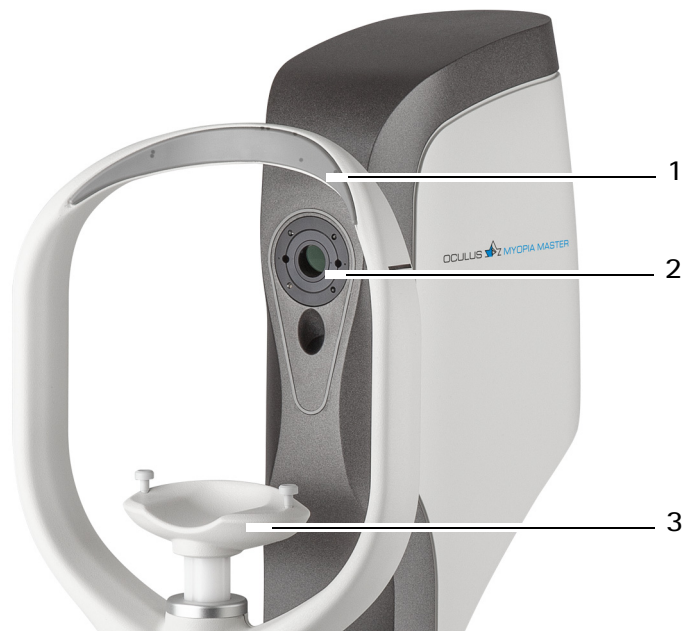

1 Head rest

2 Protective glass covers

3 Chin rest

Fig. 16-1: Cleaning

Cleaning head rest and chin rests



The Myopia Master® can be switched on for cleaning the head rest and chin rest.

During the measuring process, sweat, cosmetics, etc. from the patient can get on the head and chin rest.

- ➔ Clean these parts before examining the next patient. Use a lint-free, damp cloth.



Do not wipe more difficult spots repeatedly with a dry cloth. Instead moisten it with rubbing alcohol.

Protective glass covers for the optics

The openings in the housing for the optics are covered by protective glass covers which must be kept dust- and dirt-free.

- ➔ If they are dirty, clean the lens protection glass with a lint-free cloth moistened with alcohol.

Cleaning the Housing

- Clean the housing once a month or if necessary.
- Turn the Myopia Master® off, [sec. 9.2, page 24](#).
- If it is dirty, it is best to clean the housing plastic surfaces with a soft cloth and an anti-static cleaning agent.
- Make sure that no liquid gets into any of the openings of the Myopia Master®.
- Wipe off any residue from painted surfaces with the mixture for painted surfaces.

Cleaning the Touch Screen

- Clean the touch screen using a dry, lint-free cloth.

16.2 Disinfection



Caution

Risk of electric shock if the Myopia Master® is not completely disconnected from the mains for the disinfection.

- Turn the Myopia Master® off, [sec. 9.2, page 24](#).
 - Pull the power plug before disinfecting. When disconnecting electrical connections, pull on the respective plug and not on the cable itself.
-

Required material:

- Mikrozyd sensitive wipes premium
Fa. Schülke & Mayr
Softpack 48 pieces
Art.Nr. 165711
Schülke & Mayr GmbH
Telefon: +4940521000
Telefax: +494052100318
mail@schuelke.com
www.schuelke.com



Caution

Risk of infection after conducting a measurement on a sick patient.

If you have conducted a measurement on a sick patient, the headrest, chin rest or the housing could be contaminated.

- Disinfect the headrest after every examination and the housing whenever necessary.
- If you do not use a paper liner for the chin rest: Disinfect the chin rest after every examination.



Note

Equipment damage caused by disinfectant solution

The disinfectant solution may damage the surface of the device if it is sprayed directly on it.

- Spray the disinfectant solution onto a cleaning cloth, do not spray it directly on the device.

16.3 Maintenance

The Myopia Master® is designed so that no special maintenance is necessary. For safety reasons, we recommend that the illumination and electrical values be checked every two years.

- Please contact OCULUS Service for this.



Note

Incorrect examination results due to a damaged device

If you use a damaged device, your examination results may be incorrect.

If a fault occurs that you cannot rectify:

- Label a damaged Myopia Master® as non-operational.
- Report the damage to OCULUS Service or to your authorised dealer.
- Only use an undamaged Myopia Master®.



Additional measures are not required during preventive maintenance.



Caution

Risk of personal injury or material damage due to invisible laser radiation
The Myopia Master® contains a Class 1 laser according to DIN EN 60825-1:2015 and DIN EN 60825-1: 2001. It is an encapsulated laser system. When the Myopia Master® cover is opened, you may be exposed to invisible, Class 3R (5 mW) laser radiation.

- ➔ Never open the unit.
- ➔ For authorized service personnel only: When doing maintenance jobs, avoid looking directly into the laser beam.

16.4 Attaching Paper to the Chin Rest

If you want to attach new chin rest paper, follow these instructions:

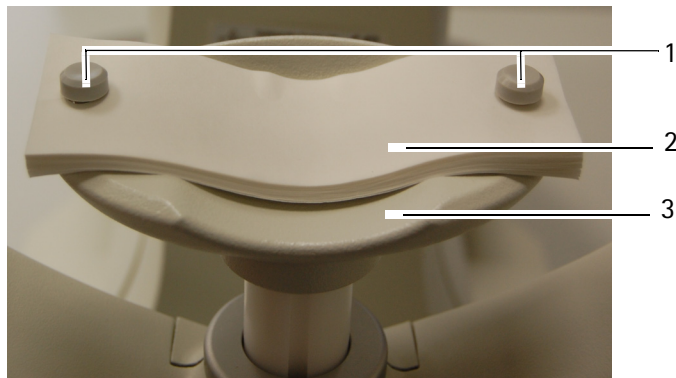

1 Pins

3 Chin rest

2 Chin rest paper

Fig. 16-2: Attaching chin rest paper

- ➔ Pull the two pins (1) out of the chin rest.
- ➔ Put the chin rest paper (2) in such a way that the holes of the paper and the chin rest (3) are aligned.
- ➔ Insert the two pins (1) in the chin rest.

16.5 Inserting a New Roll of Printer Paper



Caution

Risk of electric shock if the Myopia Master® is not completely disconnected from the mains

- ➔ Turn the Myopia Master® off, [sec. 9.2, page 24](#).
- ➔ Pull the power plug before inserting a printer paper. When disconnecting electrical connections, pull on the respective plug and not on the cable itself.

- ➔ Flip up the display

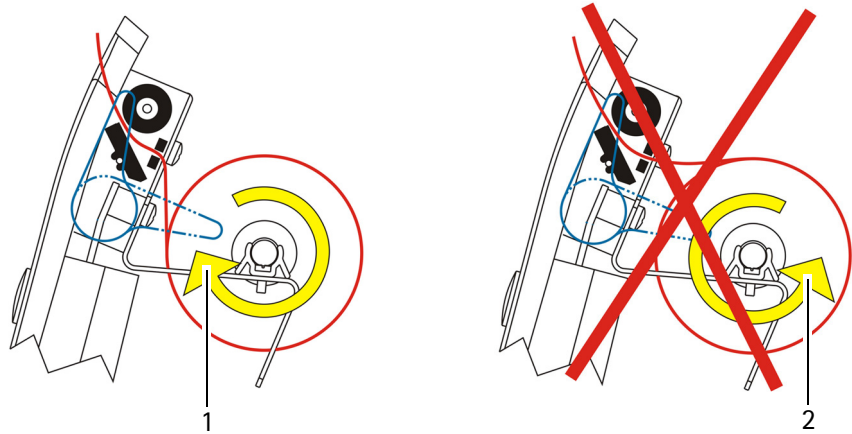

Fig. 16-3: Display for advancing and reversing the feed roller

You can advance and reverse the printer paper by pressing the buttons "Printer Feed" and "Feed Back" accordingly.

- To change the printer paper:
 - ➔ Press "Feed Back" to reverse, or roll back the printer paper.
 - ➔ Remove the feed roller from the holder and pull out the middle metal pin.
 - ➔ Push the metal pin into a new feed roller and insert the feed roller into the holder.
 - ➔ Slide the paper from below through the paper guide.

- Make sure the paper (1) is correctly aligned.



1 Proper paper guide

2 Wrong paper guide

Fig. 16-4: Inserting the paper

- Press the button "Printer Feed" so that the printer paper is pulled through the opening.
- Close the opened display unit.

17 Troubleshooting



Caution

Risk of personal injury or equipment damage due to improper troubleshooting

- ➔ Do not plug in or pull out any cables while the Myopia Master® is switched on.
- ➔ If an error occurs which you are unable to correct by following the instructions below, label the device as "out-of-order" and contact our service department or an authorized dealer.

Damage to the device cause by improper operation

- ➔ Never plug in or unplug the cable or plug while the PC and/or the Myopia Master® are switched on. This could destroy the individual units.

Error	Possible Cause	Remedy
No function when the On/Off Switch is pressed	The Myopia Master® is not connected to the power supply.	Plug the power cable into the power outlet, or into the port at the Myopia Master®.
	Power failure or power outlet is not active.	Inform the in-house electrician. Check that the connector is plugged in properly.
The printer is not printing.	No paper.	Insert a new roll of paper.
Printout has red stripes on it.	End of the paper roll.	Insert a new roll of paper.

18 Dismantling, Transport and Storage

The Myopia Master®, must be properly dismantled and packed before being transported or stored.

18.1 Disassembly

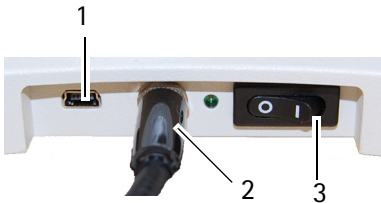

- ➔ End the current session.
- ➔ Switch off the Myopia Master® with the On/Off Switch.
- ➔ Unplug the power cord.
When disconnecting electrical connections, pull on the respective plug and not on the cable itself.
- ➔ Pack the Myopia Master® with the original packaging.

18.2 Transport and Storage Information

This device can withstand the following temperature conditions for storage and transport. The listed conditions correspond to ISO 15004-1.

Storage

Ambient temperature range	-10°C to +55°C
Relative humidity, including condensation	10% to 95%
Air pressure range	700 hPa to 1060 hPa

Transport

Ambient temperature range	-40°C to +70°C
Relative humidity range, including condensation	10% to 95%
Air pressure range	500 hPa to 1060 hPa

18.3 Transport and Storage



Caution

Risk of equipment damage due to incorrect shipment or from improper storage

- ➔ Avoid shocks, vibrations, and contamination.
- ➔ Avoid high temperatures and humidity.

- ➔ Transport the Myopia Master® carefully.

- ➔ Do not hold the device by the joystick to carry it.
- ➔ Store the Myopia Master® in compliance with the storage conditions.
- ➔ Avoid placing near heaters and moisture.

19 Disposal

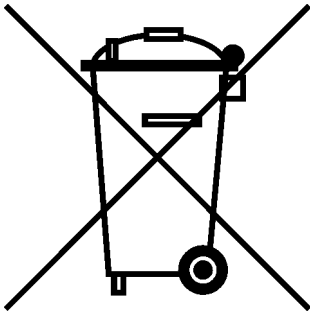

In accordance with Directive 2012/19/EC of the European Parliament and the Council, and in accordance with German law governing the marketing, return and environmentally compatible disposal of used electrical and electronic devices, such appliances must be recycled and may not be discarded as household waste.

- ➔ Dispose the Myopia Master® in a compliant manner.

20 Terms of Warranty and Servicing

20.1 Terms of Warranty

Please note the following warranty provisions:

- Prior to and while operating the device it is important that you heed the instruction manual and safety instructions.
- In accordance with legal regulations, you are entitled to a warranty for the Myopia Master®.
- If modifications are made to the Myopia Master® by unauthorized persons, all warranty claims shall be voided. Improper modifications and repairs may result in considerable hazards to users and patients.
- Any entitlement to a warranty shall also be void if unauthorized persons interfere with the supplied computer hardware and software.
- Any transport damage must be reported immediately to the shipping company. Have the transport damage noted on the bill of lading so that complaint handling and compensation of damages can proceed in an orderly manner.
- In general, our Business and Shipping Terms on the date of purchase apply.

20.2 Assumption of Liability for Functions and Damage

OCULUS will only accept responsibility for the safety, reliability and serviceability of the Myopia Master® if the unit is used in compliance with the following terms:

- Only use the equipment in conformance with this instruction manual.
- There are no parts either on or inside the Myopia Master® that require maintenance or repair by the user. If assembly work, modifications, adjustments, repairs, changes or service are performed by unauthorized personnel, or if the Myopia Master® is improperly maintained or handled, then any liability by OCULUS is voided.
- If the above-referenced work is performed by authorized persons, request a certification of the scope and type of repair, and, if necessary, the changes to the standard values or to the operating range from the service technician. This certification must contain the date of performance and statement of the performing firm, with signature.
- If requested, OCULUS will provide the service technician with a list of spare parts and additional descriptive material for this purpose.
- Make certain that only original OCULUS parts are used.

20.3 Manufacturer and Service Address

Supplemental information is available from our Service Department or from our authorized representatives.

Manufacturer and Service address:

OCULUS Optikgeräte GmbH
 Münchholzhäuser Straße 29
 35582 Wetzlar
 GERMANY
 Tel. +49 641 2005-0
 Fax +49 641 2005-295
 E-Mail: export@oculus.de
www.oculus.de



USA:

OCULUS, Inc.
 17721 59th Avenue NE
 Arlington
 WA 98223
 Tel. +1 425 670 9977
 Fax +1 425 670 0742
 E-mail: sales@oculususa.com
www.oculususa.com



21 Technical Data

Measuring modes

Myopia, AR + K, P + AR + K (optional), PARK + AXL (optional), AXL

Measuring range

Distance-pD	20 up to 80 mm (in 1 mm steps)
Measuring range Cornea diameter	10 up to 14 mm (in 0,1 steps)
Measuring range pupil diameter	1 up to 8 mm (in 0,1 steps)
Auto-Position	Positioning the height automatically (y direction)
Auto-Release	Automatic release

Pachymeter (optional)

Measuring range	200 – 1200 μ m
Measured points	600
Measuring time	approx. 1 s
Light source	blue LED (455 nm, UV free)

Auto-refractometer

Corneal vertex distance (VD)	0; 10,5; 12; 13,75; 15; 16,5 mm
Sphere	-20 – +22 D (VD = 12 mm) (increments: 0.01; 0,12; 0,25 D)
Cylinder	10 D (VD = 12 mm) (increments: 0,01; 0,12; 0,25 D)
Axis	1 – 180° (increments: 1°)
Minimum pupil diameter	2.5 mm

Axial length

Axial length 14 – 40 mm

Classification according to IEC 60601 - 1

Protection against electric shock: Protection class	2
Insulation of applied parts	Type B
Protection against foreign objects, contact and water	IP20

Ambient operating requirements

Temperature	+10 – +35 °C
Humidity	30 – 90%
Air pressure	800 – 1060 hPa

Storage requirements

Ambient temperature	-10 – +55 °C
Relative humidity	10 – 95%
Air pressure	700 – 1060 hPa

Transport requirements

Ambient temperature range	-40 – +70°C
Relative humidity range, including condensation	10 – 95%
Air pressure range	500 – 1060 hPa

Power adapter

Power adapter	GSM60B15-P1J (05150725)
AC input	80 – 264 VAC
Frequency	47 – 63 Hz
DC output	15 V DC/4 A, 60 W max.
Fuses	Integrated overcurrent shut-off

General

Dimensions height x width x depth	266 x 538 x 493 – 523 mm
Weight	12 kg
Voltage	15 V DC/4 A
Max. power consumption	25 W
Printer	thermal-printer
Display	TFT - LCD 5.7" (touch screen)
Interface (s)	USB
Contraindications	None Noted
Lifecycle expectancy	Up to ten years

Computer

Use a computer which is in conformity with the DIN EN 62368-1 or DIN EN 60950 standard.

Recommended computer specifications	Intel® Core™ i5, 500 GB HDD, 8 GB RAM, Windows® 10, Intel® HD Graphics
-------------------------------------	--

CE in accordance with Regulation (EU) 2017/745 on Medical Devices.



The unit is a Class IIa product.
 Conformity assessment procedure: (EU) 2017/745 MDR, Annex IX, Chapters I and III

**Classification according to
 DIN EN 60825-1:2015 and DIN EN 60825-1: 2001**

The unit contains a Class 1 laser.	
Maximum output of the laser radiation	0.7 mW
Single pulse duration	510 – 760 ms
Pulse count per examination	6x
Wavelength	880 nm

22 Annex

22.1 Electromagnetic Compatibility

Medical electrical equipment is subject to special precautionary requirements with respect to EMC, and must be installed and operated according to the EMC-Instructions contained in the accompanying paperwork.

No special measures need be observed in respect of OCULUS devices and systems.

Portable and mobile RF-communications devices can interfere with electrically operated medical devices.

Produced in the consideration of permissible deterioration during or caused by the EMC testing without affecting the essential performance criteria.



Caution

The use of accessories, transducers and cables not specified by OCULUS (for example as replacement parts) may result in increased emissions or decreased immunity of the Myopia Master®.

- Use only the original accessories, transducers and cables specified by OCULUS.

The use of accessories, transducers and cables specified by OCULUS with devices other than the Myopia Master® may result in increased emissions or decreased immunity of the other device.

- Do not use the accessories, transducers and cables specified by OCULUS with devices other than the Myopia Master®.
-

To be in compliance with the requirements of the IEC 60601-1-2 the following types of equipment, accessories, power adapters and cables must be used.

Order number	Description	
68100	Myopia Master® Advanced, with chin and head rest, incl. auto-refractometer, keratometry, axial length, pachymetry	
68110	Myopia Master® Advanced, without chin and head rest, incl. auto-refractometer, keratometry, axial length, pachymetry	
68120	Myopia Master® Basic, with chin and head rest, incl. auto-refractometer, keratometry, axial length	
68130	Myopia Master® Basic, without chin and head rest, incl. auto-refractometer, keratometry, axial length	
5200905	Cable, EU	1.8 m
5200915	Cable, GB (optional)	1.8 m
5200910	Cable, USA (optional)	1.8 m
5200920	Cable, AU (optional)	1.8 m
5200925	Cable, Argentina (optional)	1.8 m
05150725	Power adapter GSM60B15-P1J	
015692000010	USB FS MED-Isolator	
05200600	USB mini cable	1 m (39.4 in)

22.2 Guidance and Manufacturer's Declaration - Electromagnetic Emissions and Immunity for the Myopia Master®

Guidance and manufacturer's declaration electromagnetic emissions IEC 60601-1-2: 2015, based to table 1

The OCULUS Myopia Master® is intended for operation in the electromagnetic environment specified below. The user of the Myopia Master® should ensure that it is being used in such an environment.

Emissions test	Compliance	Electromagnetic environment - Guidelines
RF emissions CISPR 11	Group 1	The Myopia Master® uses RF energy only for its internal function. Therefore, its RF emissions are very low and are not likely to cause any interference in nearby electronic equipment.
HF-emissions CISPR 11	Class B	
Harmonics emissions IEC 61000-3-2	Class A	
Voltage fluctuations / flicker emissions IEC 61000-3-3	complies	

Electromagnetic immunity, IEC 60601-1-2: 2015, based on table 4			
Immunity test	IEC 60601 test level	Compliance level	Electromagnetic environment – Guidelines
Electrostatic discharge (ESD) IEC 61000-4-2	± 8 kV contact ± 15 kV air	± 8 kV ± 15 kV	Floors should be made of wood or concrete or covered with ceramic tiles. If the floor is covered with synthetic material, the relative humidity must be at least 30%.
Power frequency (50/60Hz) magnetic field IEC 61000-4-8	30 A/m 50 Hz or 60 Hz	30 A/m 50 Hz or 60 Hz	Power frequency magnetic fields should be at levels characteristic of a typical location in a typical commercial or hospital environment.
Electromagnetic immunity, IEC 60601-1-2: 2015, based on table 5, 8			
Electrical Fast transient/bursts IEC 61000-4-4	± 2 kV for power supply lines 100 kHz repetition frequency ± 1 kV for input/output lines	± 2 kV ----- ± 1 kV	Mains power quality should be that of a typical commercial or hospital environment.
Surge IEC 61000-4-5	± 1 kV line(s) to line(s) ± 2 kV line(s) to earth	± 1 kV differential mode ± 2 kV line(s) to earth	Mains power quality should be that of a typical commercial or hospital environment.
Voltage dips, short interruptions, and voltage variations on power supply input lines IEC 61000-4-11	0% U_T ; 1/2 period at 0, 45, 90, 135, 180, 225, 270 and 315 degree 0% U_T ; 1 period and 70% U_T ; 25/30 periods Single-phase: at 0 degree 0% U_T ; 250/300 periods	0% U_T ; 1/2 period at 0, 45, 90, 135, 180, 225, 270 and 315 degree 0% U_T ; 1 period and 70% U_T ; 25/30 periods Single-phase: at 0 degree 0% U_T ; 250/300 periods	Mains power quality should be that of a typical commercial or hospital environment. If the user of the Myopia Master® requires continued operation during power mains interruptions, it is recommended that the Myopia Master® be powered from an uninterruptible power supply or battery.
Note: U_T is the a.c. mains voltage prior to application of the test level.			

Electromagnetic immunity, IEC 60601-1-2: 2015

Immunity test	IEC 60601 test level	Compliance level	Electromagnetic environment - Guidelines
<p>Conducted RF IEC 61000-4-6</p> <p>Radiated RF IEC 61000-4-3</p>	<p>3 V_{eff} 150 KHz to 80 MHz</p> <p>6 V in ISM- and amateur radio frequency bands between 150 kHz and 80 MHz</p> <p>80% AM to 1 kHz</p> <p>3 V/m 80 MHz to 2,7 GHz</p> <p>80% AM at 1 kHz</p>	<p>V_{eff} = 3 V</p>	<p>Portable and mobile RF communications equipment should be used no closer to any part of Myopia Master®, including cables, than the recommended separation distance calculated from the equation applicable to the frequency of the transmitter.</p> <p>Recommended separation distance</p> $d = \left[\frac{3,5}{(V_1)} \right] \sqrt{P}$ $d = \left[\frac{3,5}{(E_1)} \right] \sqrt{P} \quad 80\text{MHz to } 800 \text{ MHz}$ $d = \left[\frac{7}{(E_1)} \right] \sqrt{P} \quad 800 \text{ MHz to } 2.5 \text{ GHz}$ <p>where P is the maximum output power rating of the transmitter in watts (W) according to the transmitter manufacturer and d is the recommended separation distance in metres (m).</p> <p>Field strength from fixed RF transmitters, as determined by an electromagnetic site survey (a), should be less than the compliance level in each frequency range (b).</p> <p>Interferences may occur in the vicinity of equipment marked with the following symbol:</p> 

- Note 1: At 80 Hz and 800 MHz, the higher frequency range applies.
- Note 2: These guidelines may not apply in all situations. Electromagnetic propagation is affected by absorption and reflection from structures, objects and people.

- a. Field strengths from fixed transmitters, such as base stations for radio (cellular/cordless) telephones and land mobile radios, amateur radios, AM and FM radio broadcast, and TV broadcast cannot be predicted theoretically with accuracy. To assess the electromagnetic environment due to fixed RF transmitters, and electromagnetic site survey should be considered. If the measured field strength in the location in which the Myopia Master® is used exceeds the applicable RF compliance level above, the Myopia Master® should be observed to verify normal operation. If abnormal performance is observed, additional measures may be necessary, such as re-orienting or relocating the Myopia Master®.
- b. Over the frequency range 150 KHz to 80 MHz, field strengths should be less than 3 V/m.

Recommended separation distances between portable and mobile RF communications equipment and the Myopia Master®, IEC 60601-1-2:2015, table 6

The Myopia Master® is intended for use in an electromagnetic environment in which radiated RF disturbances are controlled. The customer or the user of the Myopia Master® can help prevent electromagnetic interference by maintaining a minimum distance between portable and mobile RF communications equipment (transmitters) and the Myopia Master® as recommended below, according to the maximum output power of the communications equipment.

Rated maximum output power of transmitter W	Separation distance according to frequency of transmitter m		
	150 KHz to 80 Mhz $d= 1.2 \sqrt{P}$	80 MHz to 800 MHz $d= 1.2 \sqrt{P}$	800 MHz to 2.5 GHz $d= 2.3 \sqrt{P}$
0.01	0.12	0.12	0.23
0.1	0.38	0.38	0.73
1	1.2	1.2	2.3
10	3.80	3.80	7.3
100	12	12	23

For transmitters rated at a maximum output power not listed above, the recommended separation distance d in metres (m) can be estimated using the equation applicable to the frequency of the transmitter, where P is the maximum output power rating of the transmitter in watts (W) according to the transmitter manufacturer.

NOTE 1: At 80 MHz and 800 MHz, the separation distance for the higher frequency range applies.

NOTE 2: These guidelines may not apply in all situations. Electromagnetic propagation is affected by absorption and reflection from structures, objects and people.

22.3 Description of the Connection

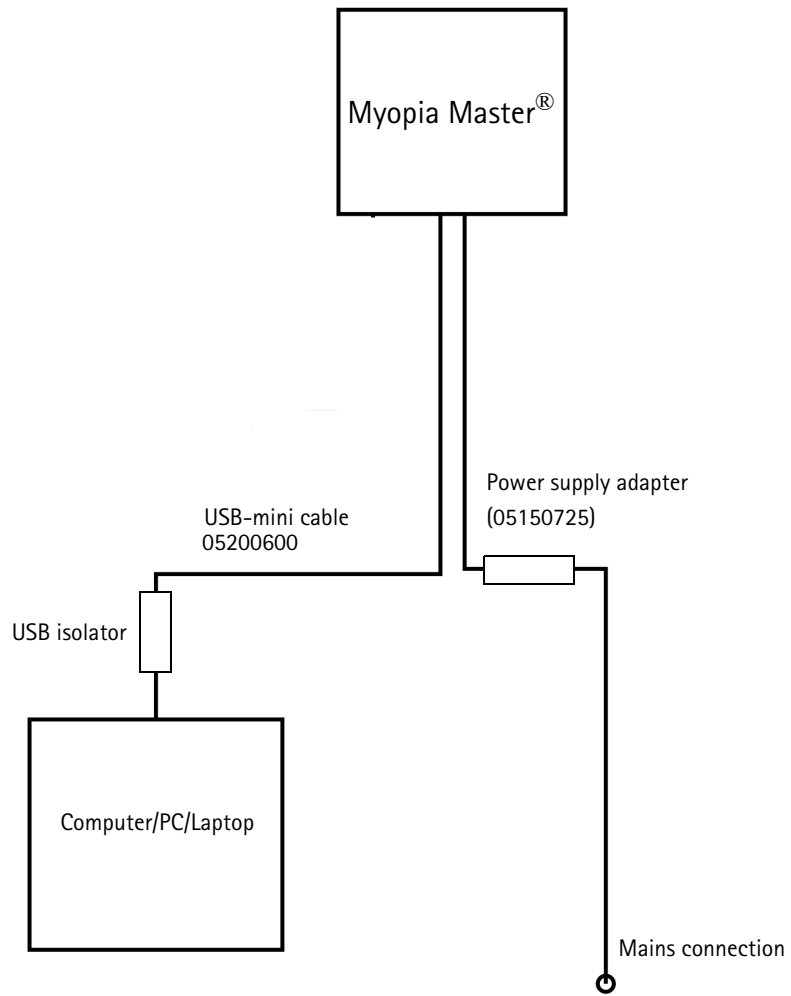

22.4 Data Sheet GSM60B15-P1J [05150725]



60W AC-DC High Reliability Medical Adaptor

GSM60B series



■ Features

- Universal AC input / Full range
- 2 pole AC inlet IEC320-C8
- Medical safety approved (2 x MOPP between primary to secondary)
- Suitable for BF application with appropriate system consideration
- Low leakage current <50uA
- No load power consumption<0.1W
- Energy efficiency level VI(Except 5~9V for Level V)
- Comply with EISA 2007/DoE,NRCAn, AU/NZ MEPS, EU ErP and meet CoC Version 5
- Built-in active PFC function
- High efficiency up to 91.5%
- Fanless design with -30~+60°C working temperature
- Class II power (without earth pin)
- Protections: Short circuit / Overload / Over voltage / Over temperature
- Fully enclosed plastic case
- LED indicator for power on
- 100% full load burn-in test
- Optional lock type DC plug
- 3 years warranty

■ Applications

- Mobile clinical workstation
- Oral irrigator
- Portable hemodialysis machine
- Breath Machine
- Medical computer monitor

■ Description

GSM60B is a highly reliable, 60W desktop style single-output green medical adaptor series. This product is equipped with a 2-pin (no FG) standard IEC320-C8 power plug, adopting the input range from 80VAC to 264VAC. The entire series supplies different output voltages between 5VDC and 48VDC that can satisfy the demands for various kinds of medical electrical devices. The circuitry design meets the international medical standards (2*MOPP), having an ultra low leakage current (<50 uA), fitting the medical devices in direct electrical contact with the patients.

With the efficiency up to 91.5% and the extremely low no-load power consumption below 0.1W, GSM60B is compliant with USA EISA 2007/DoE, Canada NRCAn, Australia and New Zealand MEPS, EU ErP, and meet Code of Conduct (CoC) Version 5. The supreme feature allows the adaptor to save the energy when it is either under the operating mode or the standby mode. The entire series utilizes the 94V-0 flame retardant plastic case, providing the double insulation that effectively prevents electrical shock. GSM60B is approved with the international medical safety certificates.

■ Model Encoding

GSM60 B 05 -P1J

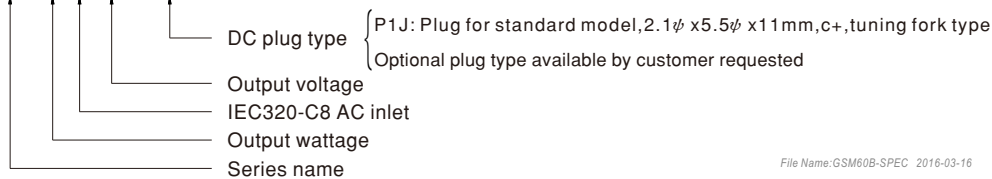

File Name:GSM60B-SPEC 2016-03-16



60W AC-DC High Reliability Medical Adaptor

GSM60B series

SPECIFICATION

ORDER NO.		GSM60B05-P1J	GSM60B07-P1J	GSM60B09-P1J	GSM60B12-P1J	GSM60B15-P1J	GSM60B18-P1J	GSM60B24-P1J	GSM60B48-P1J	
OUTPUT	SAFETY MODEL NO.	GSM60B05	GSM60B07	GSM60B09	GSM60B12	GSM60B15	GSM60B18	GSM60B24	GSM60B48	
	DC VOLTAGE <small>Note.2</small>	5V	7.5V	9V	12V	15V	18V	24V	48V	
	RATED CURRENT	6A	6A	6A	5A	4A	3.33A	2.5A	1.25A	
	CURRENT RANGE	0 ~ 6A	0 ~ 6A	0 ~ 6A	0 ~ 5A	0 ~ 4A	0 ~ 3.33A	0 ~ 2.5A	0 ~ 1.25A	
	RATED POWER (max.)	30W	45W	54W	60W	60W	60W	60W	60W	
	RIPPLE & NOISE (max.) <small>Note.3</small>	100mVp-p	100mVp-p	100mVp-p	100mVp-p	100mVp-p	150mVp-p	180mVp-p	240mVp-p	
	VOLTAGE TOLERANCE <small>Note.4</small>	± 5.0%	± 5.0%	± 5.0%	± 3.0%	± 3.0%	± 3.0%	± 3.0%	± 2.5%	
	LINE REGULATION <small>Note.5</small>	± 1.0%	± 1.0%	± 1.0%	± 1.0%	± 1.0%	± 1.0%	± 1.0%	± 1.0%	
	LOAD REGULATION	± 5.0%	± 5.0%	± 5.0%	± 3.0%	± 3.0%	± 3.0%	± 3.0%	± 2.5%	
	SETUP, RISE TIME <small>Note.6</small>	1000ms, 30ms / 230VAC 1500ms, 30ms / 115VAC at full load								
HOLD UP TIME (Typ.)	50ms / 230VAC 15ms / 115VAC at full load									
INPUT	VOLTAGE RANGE <small>Note.7</small>	80 ~ 264VAC 120 ~ 370VDC								
	FREQUENCY RANGE	47 ~ 63Hz								
	EFFICIENCY (Typ.)	81.5%	86%	87.5%	88%	88.5%	89%	90%	91.5%	
	AC CURRENT (Typ.)	1.4A / 115VAC 1A / 230VAC								
	INRUSH CURRENT (Typ.)	30A / 115VAC 65A / 230VAC								
LEAKAGE CURRENT(max.)	Touch current < 50µA/264VAC									
PROTECTION	OVERLOAD	105 ~ 160% rated output power Protection type : Hiccup mode, recovers automatically after fault condition is removed								
	OVER VOLTAGE	5.25 ~ 6.75V	7.88 ~ 10.13V	9.45 ~ 12.15V	12.6 ~ 16.2V	15.75 ~ 20.25V	18.9 ~ 24.3V	25.2 ~ 32.4V	50.4 ~ 64.8V	
		Protection type : Shut down o/p voltage, re-power on to recover								
ENVIRONMENT	OVER TEMPERATURE	Shut down o/p voltage, re-power on to recover								
	WORKING TEMP.	-30 ~ +60°C (Refer to "Derating Curve")								
	WORKING HUMIDITY	20% ~ 90% RH non-condensing								
	STORAGE TEMP., HUMIDITY	-40 ~ +85°C, 10 ~ 95% RH								
	TEMP. COEFFICIENT	± 0.03% / °C (0 ~ 40°C)								
SAFETY & EMC (Note. 8)	VIBRATION	10 ~ 500Hz, 2G 10min./1cycle, period for 60min. each along X, Y, Z axes								
	SAFETY STANDARDS	ANSI/AAMI ES60601-1 / ES60601-1-11, TUV EN60601-1 / 60601-1-11 approved								
	ISOLATION LEVEL	Primary-Secondary: 2xMOPP								
	WITHSTAND VOLTAGE	I/P-O/P:4KVAC								
	ISOLATION RESISTANCE	I/P-O/P:100M Ohms / 500VDC / 25°C / 70% RH								
	EMC EMISSION	Compliance to EN55011(CISPR11) class B, EN61000-3-2,3, FCC PART 15 class B,CAN ICES-3(B)/NMB-3(B)								
OTHERS	EMC IMMUNITY	Compliance to EN61000-4-2,3,4,5,6,8,11, EN55024, EN60601-1-2, EN61204-3 medical level, criteria A								
	MTBF	720K hrs min. MIL-HDBK-217F(25°C)								
	DIMENSION	125*50*31.5mm (L*W*H)								
CONNECTOR	PACKING	0.32Kg; 40pcs/13.8Kg/1.05CUFT								
	PLUG	See page 3 ; Other type available by customer requested								
	CABLE	See page 3 ; Other type available by customer requested								
NOTE	<ol style="list-style-type: none"> All parameters are specified at 230VAC input, rated load, 25°C 70% RH ambient. DC voltage: The output voltage set at point measure by plug terminal & 50% load. Ripple & noise are measured at 20MHz by using a 12" twisted pair terminated with a 0.1µf & 47µf capacitor. Tolerance: includes set up tolerance, line regulation, load regulation. Line regulation is measured from low line to high line at rated load. Length of set up time is measured at first cold start. Turning ON/OFF the power supply may lead to increase of the set up time. Derating may be needed under low input voltages. Pleas check the derating curve for more details. The power supply is considered as an independent unit, but the final equipment still need to re-confirm that the whole system complies with the EMC directives. For guidance on how to perform these EMC tests, please refer to "EMI testing of component power supplies." (as available on http://www.meanwell.com) 									

File Name:GSM60B-SPEC 2016-03-16



60W AC-DC High Reliability Medical Adaptor

GSM60B series

Derating Curve

Ambient Temperature (°C)	Load (%)
-30	100
0	100
10	100
20	100
30	100
40	100
50	75
60	50
70	0

Static Characteristics

Input Voltage (VAC) 60Hz	Load (%)
80	80
90	90
100	100
110	100
120	100
130	100
140	100
150	100
160	100
170	100
180	100
190	100
200	100
210	100
220	100
230	100
240	100
250	100
264	100

Mechanical Specification

Case No. GSM60B Unit:mm

Plug Assignment

Standard plug: P1J

P1J	
P/N	OUTPUT
CENTER	+

Optional lock type plug: P2S
SWITCHCRAFT S761K plug equivalent

Outside Inside

Installation Manual

Please refer to : <http://www.meanwell.com/webnet/search/InstallationSearch.html>

File Name:GSM60B-SPEC 2016-03-16

22.5 Notes for integration into an IT-Network

The device, in conjunction with the connected computer and the device software running on it, forms a programmable electrical medical system (PEMS) according to IEC 60601-1.

It is essential that you follow the cybersecurity instructions section of "Safety Instructions" in the device instruction manual.

Please note the following information for implementing an integration of the PEMS into an IT-Network:

The purpose of integrating the PEMS into an IT-Network can be:

- Licensing by local license server
- Storage and retrieval of the examination data on a local network drive
- Printing
- Data export
- DICOM workflow

Required characteristics of the IT-Network into which the PEMS is to be integrated:

- Prefer wired LAN connection
- IPv4 network
- Fast-Ethernet (100 Mbit/s minimum)

Required configuration of the IT-Network into which the PEMS is to be integrated:

- Licensing: required opened ports: 3968 TCP; 51371 - 51372 UDP
- Storage, printing, data export: File and Printer Sharing for Microsoft Networks (SMB 3.0 or higher - required opened port: 445]
- DICOM Storage Service Class = PACS
- DICOM Worklist Management Service Class (Modality Worklist Server)

Technical specifications of the network connection with the PEMS, including the specifications of data security:

- Refer to the cybersecurity section of "Safety Instructions" in the device instruction manual.
- Refer to the "Floating License Key - License management for software options" instruction manual (if applicable)
- Refer to device specific DICOM interface description (if applicable)

The intended flow of information between PEMS, the IT-Network and other devices in the IT-Network and the intended routing through the IT-Network

- License handling from local license server to PEMS and vice versa
- Storage and data export to local network storage and loading from local network storage
- Printout to local printer

List of hazard situations that result from the IT-Network being unable to provide the features that are required to fulfill the purpose of integrating the PEMS into to meet the IT-Network:

- Loss of data
- unsuitable data exchange
- Data corruption
- unsuitable temporal data allocation
- unexpected data reception
- unauthorized access to data



Connection of the PEMS to an IT-Network that includes other equipment could result in previously unidentified risks to patients, operators or third parties.

The responsible organization should identify, analyze, evaluate and control these risks.

Subsequent changes to the IT-Network could introduce new risks and require additional analysis.

Changes to the IT-Network include:

- changes in IT-Network configuration
- connection of additional items to the IT-Network
- disconnecting items from the IT-Network
- update of equipment connected to the IT-Network

Manufacturer and Service Address

Headquarters:

OCULUS Optikgeräte GmbH
Münchholzhäuser Straße 29 • 35582 Wetzlar • GERMANY
Tel. +49 641 2005-0 • Fax +49 641 2005-255
E-Mail: sales@oculus.de • www.oculus.de

USA:

OCULUS, Inc.
17721 59th Avenue NE • Arlington • WA 98223
Tel. +1 425 670 9977 • Fax +1 425 670 0742
Email: sales@oculususa.com • http://www.oculususa.com

G/68100/EN
Lot:

